



U

HUNTER®

VOLUME
XII
2025



HUNTER INTERNATIONAL GMBH

Mittelbreede 5
33719 Bielefeld
Germany

fon: +49 (0) 521 16399 – 500

fax: +49 (0) 521 16399 – 555

www.hunter.de

Bitte halten Sie bei Anfragen Ihre Kundennummer bereit. Unser Serviceteam steht Ihnen montags bis freitags von 8.00 - 16.30 Uhr gerne zur Verfügung.

Please keep your customer number ready when making enquiries. Our service team will be happy to assist you Monday to Friday from 8.00 a.m. - 4.30 p.m.

Kundenservice Deutschland & Österreich

International Customer Service

Bestellung B2B Online-Shop b2b.hunter.de	Order via B2B Online-Shop: b2b.hunter.de
Bestellung per E-Mail bestellung@dogsport-gmbh.de	Order via email: info@hunter.de
Bestellung per Fax fax: +49 (0) 521 16399 – 555	Order via fax: fax: +49 (0) 521 16399 – 555
Allgemeine Anfragen info@dogsport-gmbh.de	General enquiries info@hunter.de
Reklamation reklamation@hunter.de	Complaints Please get in touch with your responsible contact person.
Hotline Deutschland & Österreich fon: +49 (0) 521 16399 – 760	Hotline International fon: +49 (0) 521 16399 – 740

Ihre HUNTER Kundennummer
Your HUNTER customer number



45 Years of Excellence – Made in Germany

— 1980 - 2025 —



VOLUME
XII

2025

including
stylecats®
by HUNTER



MEIN ABENTEUER
BEGINNT MIT DIR!

My adventure begins with you!



Lieber HUNTER-Freund,

es ist uns eine Herzensangelegenheit, Dir unseren neuen Produktkatalog vorzustellen – ein Katalog, der voller liebevoll gestalteter Innovationen für unsere treuen Begleiter, Hunde und Katzen, steckt! In jedem einzelnen Produkt steckt nicht nur unser Engagement, sondern auch die tiefe Liebe zu den Tieren und zu Dir, unserem geschätzten Kunden. Wir wissen, wie wichtig Dir die Bindung zu Deinem pelzigen Freund ist. Deshalb haben wir mit viel Leidenschaft und Hingabe Produkte entwickelt, die das Leben Deiner Vierbeiner bereichern und die gemeinsamen Momente noch schöner machen. Von kuscheligen Schlafplätzen, über spannende Spielzeuge bis hin zu praktischen Zubehörteilen – wir möchten, dass Du und Dein Tier die Zeit miteinander in vollen Zügen genießen könnt. Mit großer Freude präsentieren wir Dir zudem unsere neue Premium-Marke stylecats® für Katzen. Unser Anspruch ist es, die gleiche Erfolgsqualität zu erreichen, die wir bereits in der Kategorie Hund etabliert haben. stylecats® steht für minimalistisches, hochwertiges Katzenzubehör, das Funktionalität und stilvolles Design vereint. Die Marke bietet Kratzmöbel, Betten, Höhlen und Spielzeug, die katzenfreundlich und zugleich ästhetische Wohnaccessoires sind. Zusätzlich legen wir großen Wert auf Nachhaltigkeit: Wir verfolgen das Ziel, bis 2030 an unserem Standort klimaneutral zu sein. Selbstverständlich wurde auch dieser Katalog wieder klimaneutral gedruckt. Wir werden unserer Verantwortung gerecht und schaffen Werte – für eine gesunde Zukunft unserer Vierbeiner und unseres Planeten. Gemeinsam können wir so viel bewegen! Lass uns zusammen neue Wege gehen, um das Leben unserer geliebten Haustiere noch glücklicher und gesünder zu gestalten. Deine Zufriedenheit und das Wohl Deiner Tiere liegen uns am Herzen, und wir sind überzeugt, dass wir gemeinsam eine wunderbare Reise antreten können. Danke, dass Du Teil unserer HUNTER Familie bist. Lass uns zusammen die Liebe zu unseren Tieren feiern und die Welt ein Stückchen besser machen!

Dear HUNTER friend, it is a matter close to our hearts to introduce you to our new product catalogue - a catalogue full of lovingly designed innovations for our faithful companions, dogs and cats! Every single product is not only the result of our commitment, but also of our deep love for animals and for you, our valued customer. We know how important it is for you to bond with your furry friend. That is why we have developed products with a great deal of passion and dedication that enrich the lives of your four-legged friends and make the moments you spend together even more enjoyable. From cosy sleeping areas and exciting toys to practical accessories - we want you and your pet to enjoy your time together to the full. We are also delighted to present our new premium brand stylecats® for cats. Our aim is to achieve the same successful quality that we have already established in the dog category. stylecats® stands for minimalist, high-quality cat accessories that combine functionality and stylish design. The brand offers scratching furniture, beds, caves and toys that are both cat-friendly and aesthetic home accessories. We also attach great importance to sustainability: we are pursuing the goal of being climate-neutral at our site by 2030. It goes without saying that this catalogue was also printed in a climate-neutral way. We are living up to our responsibility and creating value - for a healthy future for our four-legged friends and our planet. Together we can achieve so much! Let's break new ground together to make the lives of our beloved pets even happier and healthier. We care about your happiness and the well-being of your pets, and we are convinced that together we can embark on a wonderful journey. Thank you for being part of our HUNTER family. Let's celebrate the love for our animals together and make the world a better place!

JOSSENBRINK • NADINE TRAUTWEIN • JANA







INHALT

Content

Einführung | Introduction

02

- 8 Kundenservice | Customer Service
- 12 Leder | Leather
- 14 Produkte, die echte Freude machen |
Products that bring real joy

Für Hunde | For dogs

16

- 18 Halsbänder, Geschirre & Leinen |
Collars, harnesses & leashes
- 20 Rindsleder | Cow leather
- 104 Kunstleder | Artificial leather
- 114 Tau | Rope
- 138 Nylon
- 212 Outdoor, Hundesport & Ausbildung |
Outdoor, Sport & Training
- 238 Zubehör | Accessoires
- 248 Reise & Transport | Travel & Transport
- 276 Spielzeug | Toys
- 314 KONG®
- 370 Näpfe | Bowls
- 390 Snacks | Rewards
- 402 Pflege & Hygiene | Care & Hygiene
- 414 Bekleidung | Clothing
- 446 Schlafplätze | Beds

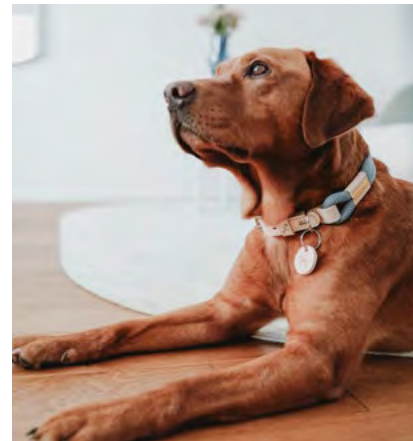

stylecats®

by HUNTER

Für Katzen | For cats 494

494 stylecats®

512 KONG®

Specials 520

520 Verkaufshilfen | Sales Promotions

538 Shop-in-Shop

542 Sachregister | Glossary

550 HUNTER Team

568 Allgemeine Geschäftsbedingungen |
General Terms and Conditions



b2b.hunter.de

WIR SIND FÜR DICH DA!

We are here for you

Liebe Kundinnen und Kunden,

Wir arbeiten stetig daran, unseren Service zu optimieren und bestmöglich für Sie da zu sein. Aus diesem Grund haben wir eine Hotline ins Leben gerufen, über die Sie unsere Kundenbetreuung direkt erreichen können.

Sie haben Fragen zu Artikeldetails, Lieferterminen oder Bestellungen?

Wir sind gerne für Sie da! Rufen Sie uns an unter:

+49 (0)521 16399-760

Kennen Sie schon unser B2B Händlerportal?

Wenn nicht: Kontaktieren Sie uns, wir erklären Ihnen gerne die vielen Funktionen unserer Bestellplattform. Oder lassen Sie sich direkt Ihre Zugangsdaten geben und profitieren Sie von den vielen Vorteilen, die unser B2B Shop bietet:

- Erreichbarkeit 24/7
- Kostenlose Lieferung ab 1€ Bestellwert*
- Lieferung innerhalb von 24 bis maximal 48 Stunden*
- Verfügbarkeiten und Liefertermine prüfen
- Merktzettel anlegen
- Sortimentsübersicht
- Schnellerfassung
- Statistiken
- SALE Bereich
- Regelmäßiger Newsletter-Versand zu Aktionen und wichtigen Informationen

Wir freuen uns auf Sie!

Dear customers,

We are constantly working on optimising our service and being there for you in the best possible way. For this reason, we have set up a hotline where you can reach our customer service directly.

Do you have questions about item details, delivery dates or orders?

We are happy to be there for you! Call us at:

+49 (0)521 16399-740

Do you already know our B2B dealer portal?

If not: contact us, we will be happy to explain the many functions of our ordering platform to you. Or get your access data directly and benefit from the many advantages our B2B shop offers:

- *24/7 availability*
- *Delivery within 24 to maximum 48 hours**
- *Check availability and delivery dates*
- *Create a notepad*
- *Assortment overview*
- *Fast entry*
- *Statistics*
- *SALE area*
- *Regular newsletter on promotions and important information*

We look forward to hearing from you!

* innerhalb Deutschlands / within Germany

UND VERSTAND * KUNDENSERVICE
HERZ MIT





• HANDMADE WITH LOVE •
• HANDMADE WITH LOVE •



LEDER: NACHHALTIG, LANGLEBIG UND ZEITLOS

Leather: Sustainable, durable and timeless







HANDMADE WITH LOVE • HANDMADE WITH LOVE

DAS WOHL ÄLTESTE RECYCLINGPRODUKT DER WELT
Probably the oldest recycling product in the world

KEIN FAST-FASHION - LANGLEBIG & REPARABEL
No fast fashion - durable & repairable

LEDER WIRD DURCH NUTZUNG AUSSAGEKRÄFTIGER
Leather becomes more meaningful through use

**LEDER BEKOMMT EINE UNVERKENNBARE UND
WUNDERBARE PATINA**
Leather takes on an unmistakable and marvellous patina

ÖKOLOGISCHE GERBVERFAHREN
Ecological tanning processes

**WUNDERSCHÖNER NATÜRLICHER WERKSTOFF,
DER EMOTIONEN WECKT**
Beautiful natural material that arouses emotions

TEMPERATURAUSGLEICHENDE EIGENSCHAFTEN
Temperature-regulating properties

ANGENEHMER GERUCH
Pleasant odour

ROBUST UND HALTBAR
Robust and durable

ANTISTATISCH
Antistatic



HANDMADE WITH LOVE . HANDMADE WITH LOVE .





PRODUKTE, DIE ECHTE FREUDE BRINGEN!

Products that bring real joy!

Als Ledermanufaktur aus dem Herzen Deutschlands setzen wir Tag für Tag unsere Leidenschaft ein, um handgemachte Liebhaberstücke zu kreieren und die Wahrnehmung dafür zu schärfen, dass dieser wunderschöne Werkstoff nicht nur edel und langlebig ist, sondern auch als ältestes Recyclingmaterial der Welt gilt. Wir pflegen das traditionelle Sattlerhandwerk und garantieren mit unserer jahrzehntelangen Expertise höchste Qualität. Trotzdem brennen wir auch dafür, neue Wege zu gehen, innovative Materialien zu verwenden und Produktideen zu entwickeln, die so noch nicht existieren und echte Problemlöser sind. Besonders stolz sind wir darauf, dass erstmalig unsere neue Marke stylecats® einen Platz in diesem Katalog findet. Die Vision von stylecats® ist es, Katzenmöbel und -accessoires neu und modern zu denken. Wir entwerfen Produkte, die katzenfreundlich und gleichzeitig puristische Eyecatcher sind, die jede Wohnung aufwerten und das zu Konditionen, an denen Du als unser Partner Deine Freude haben wirst.

As a leather manufacturer from the heart of Germany, we use our passion every day to create handmade collector's items and raise awareness of the fact that this beautiful material is not only noble and durable, but is also the oldest recycled material in the world. We cultivate the traditional saddler's craft and guarantee the highest quality with our decades of expertise. Nevertheless, we are also keen to break new ground, source innovative materials and develop product ideas that have never been seen before and are real problem solvers. We are particularly proud that our new stylecats® brand has found a place in this catalogue for the first time. The vision of stylecats® is to rethink cat furniture and accessories in a new and modern way. We design products that are cat-friendly and at the same time purist eye-catchers that enhance any home and at conditions that you as our partner will enjoy.



Für Hunde

—— *For Dogs* ——



Halsbänder, Geschirre & Leinen

— Collars, harnesses & leashes —

Als familiengeführte Manufaktur setzen wir bei Halsbändern, Geschirren und Leinen auf hochwertige Fertigungsweisen. Mit größter Sorgfalt werden die unterschiedlichen Rohmaterialien ausgewählt und nach unseren Maßstäben handwerklicher Perfektion zu modisch-funktionalen Accessoires verarbeitet.

As a family-run manufacturer, we only use high quality production methods for our collars, harnesses and leashes. The various raw materials are selected with the utmost care and turned into fashionable and functional accessories according to our standards of technical perfection.



Rindsleder

— Cow leather —

Rindsleder charakterisiert sich vor allem durch sein hohes Maß an Stabilität und seinen kräftigen Griff. Dabei besticht es durch seine Vielseitigkeit. Ob softes Vollrindsleder mit glatter Oberfläche, weiches Nappaleder mit einzigartiger Narbung oder edles Nubukleder mit samtiger Haptik. Ob durchgefärbt in kräftigen Tönen oder naturbelassen und vegetabil gegerbt. Rindsleder ist ein wahrer Alleskönner und dabei Naturprodukt und Hightech-Artikel zugleich, der mit der Zeit nur noch schöner wird.

Cow leather is characterised above all by its high degree of stability and its strong feel. At the same time, it impresses with its versatility. Whether soft genuine cow leather with a smooth finish, supple nappa leather with its unique texture or elegant nubuck leather with a velvety feel. Whether dyed through in strong tones or natural and vegetable-tanned. Cowhide is a true all-rounder and at the same time a natural product and high-tech article that only becomes more beautiful with time.

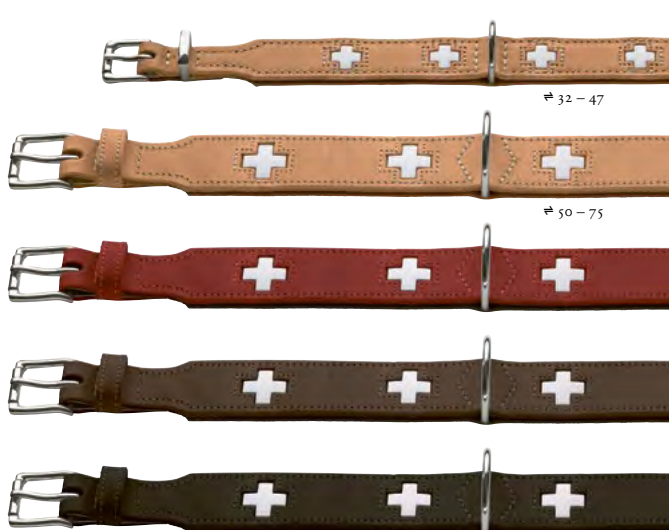

MADE
IN
GERMANY



№	⇒	↔	↔
32	XS	24 – 28 cm	2,6 cm
37	XS-S	30 – 34 cm	2,6 cm
42	S-M	35 – 40 cm	2,6 cm
47	S-M	38 – 44 cm	3,0 cm
50	S-M	35 – 43 cm	3,9 cm
55	M	41 – 49 cm	3,9 cm
60	M-L	47 – 54 cm	3,9 cm
65	L	51 – 58 cm	3,9 cm
70	L-XL	56 – 64 cm	3,9 cm
75	XL	61 – 68 cm	3,9 cm

Halsband Swiss

Collar | Collier | Collar | Collare | Halsbånd

Rindsleder | Cow leather | Cuir de bœuf | Cuero de vacuno | Cuoio di bovina | Okselæder

natur/beige | tan/tan | nature/beige | natural/beige | naturale/beige | natur/beige

32	46162		37	46163	
42	46164		47	46165	
50	46166		55	46167	
60	46168				

rot/schwarz | red/black | rouge/noir | rojo/negro | rosso/nero | rød/sort

32	42158		37	42048	
42	42049		47	42050	
50	41955		55	41867	
60	41868		65	41869	
70	42813		75	42814	

braun/schwarz | brown/black | marron/noir | marrón/negro | marrone/nero | brun/sort

32	42825		37	42826	
42	42827		47	42828	
50	42829		55	42830	
60	42831		65	42832	
70	42833				

schwarz | black | noir | negro | nero | sort

32	42815		37	42816	
42	42817		47	42818	
50	42819		55	42820	
60	42821		65	42822	
70	42823				





Führleine Swiss

Leash | Laisse | Correa | Guinzaglio da passeggio | Line

Rindsleder | *Cow leather* | Cuir de bœuf | *Cuero de vacuno* | Cuoio di bovina | *Okselæder*

natur/beige | tan/tan | nature/beige | natural/beige | naturale/beige | natur/beige

18/100 46171

rot/schwarz | red/black | rouge/noir | rojo/negro | rosso/nero | rød/sort

18/100 43153

braun/schwarz | brown/black | marron/noir | marrón/negro | marrone/nero | brun/sort

18/100 43157

schwarz | black | noir | negro | nero | sort

18/100 43161



Verstellbare Führleine Swiss

Training leash | Laisse réglable | Correa ajustable | Guinzaglio da passeggio regolabile | Justerbar line

Rindsleder, 3-fache Verstellmöglichkeit | *Cow leather, 3-fold adjustable* | Cuir de bœuf, 3 possibilités de réglage | *Cuero de vacuno, 3 posibilidades de ajuste* | Cuoio di bovina, 3 possibilità di regolazione | *Okselæder, 3-trins indstilling*

natur/beige | tan/tan | nature/beige | natural/beige | naturale/beige | natur/beige

13/200 46172 18/200 46173

rot/schwarz | red/black | rouge/noir | rojo/negro | rosso/nero | rød/sort

13/200 43154 18/200 43155

braun/schwarz | brown/black | marron/noir | marrón/negro | marrone/nero | brun/sort

13/200 43158 18/200 43159

schwarz | black | noir | negro | nero | sort

13/200 43162 18/200 43163



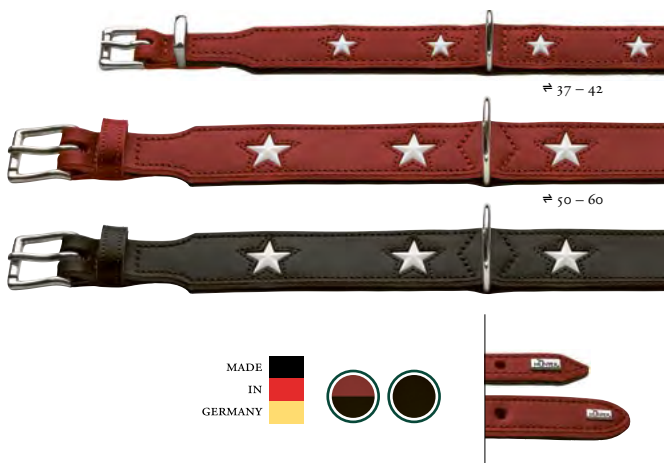

Halsband MAGIC STAR

Collar | Collier | Collar | Collare | Halsbånd

Rindsleder | Cow leather | Cuir de bœuf | Cuero de vacuno | Cuoio di bovina | Okselæder

rot/schwarz | red/black | rouge/noir | rojo/negro | rosso/nero | rød/sort

37	60502		42	60503	
50	60505		55	60506	
60	60507				

schwarz | black | noir | negro | nero | sort

37	60510		42	60511	
50	60513		55	60514	
60	60515				

№	⇒	↔	↔
37	XS-S	30 – 34 cm	2,6 cm
42	S-M	35 – 40 cm	2,6 cm
50	S-M	35 – 43 cm	3,9 cm
55	M	41 – 49 cm	3,9 cm
60	M-L	47 – 54 cm	3,9 cm



Verstellbare Führleine MAGIC STAR

Training leash | Laisse réglable | Correa ajustable | Guinzaglio da passeggio regolabile | Justerbar line

Rindsleder, 3-fache Verstellmöglichkeit | Cow leather, 3-fold adjustable | Cuir de bœuf, 3 possibilités de réglage | Cuero de vacuno, 3 posibilidades de ajuste | Cuoio di bovina, 3 possibilità di regolazione | Okselæder, 3-trins indstilling

rot/schwarz | red/black | rouge/noir | rojo/negro | rosso/nero | rød/sort

18/200 60520

schwarz | black | noir | negro | nero | sort

18/200 60524



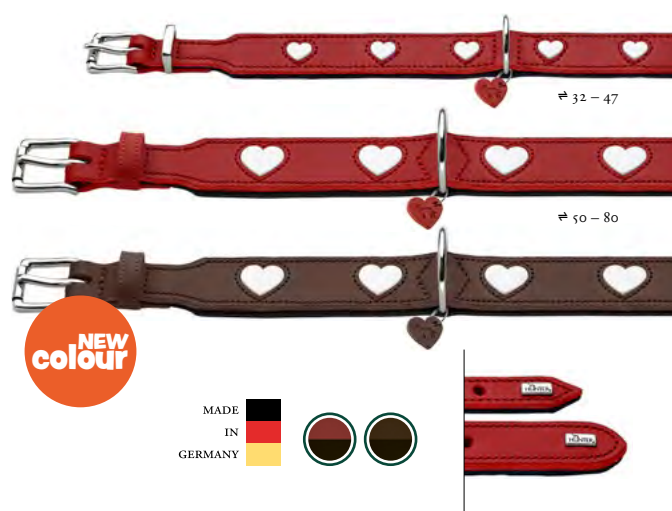

№	⇒	⇔	↔
32	XS	24 – 28 cm	2,6 cm
37	XS-S	30 – 34 cm	2,6 cm
42	S-M	35 – 40 cm	2,6 cm
47	S-M	38 – 44 cm	3,0 cm
50	S-M	35 – 43 cm	3,9 cm
55	M	41 – 49 cm	3,9 cm
60	M-L	47 – 54 cm	3,9 cm
65	L	51 – 58 cm	3,9 cm
70	L-XL	56 – 64 cm	3,9 cm
75	XL	61 – 68 cm	3,9 cm
80	XL	62 – 72 cm	3,9 cm

Halsband LOVE

Collar | Collier | Collar | Collare | Halsbånd

Rindsleder | Cow leather | Cuir de boeuf | Cuero de vacuno | Cuoio di bovina | Okselæder

rot/schwarz | red/black | rouge/noir | rojo/negro | rosso/nero | rød/sort

32	69900		37	69901	
42	69902		47	69903	
50	69904		55	69905	
60	69906		65	69907	
70	69908		75	69909	
80	69910				

braun/schwarz | brown/black | marron/noir | marrón/negro | marrone/nero | brun/sort

32	207500		37	207501	
42	207502		47	207503	
50	207504		55	207505	
60	207506		65	207507	
70	207508		75	207509	
80	207510				



Verstellbare Führleine LOVE

Training leash | Laisse réglable | Correa ajustable | Guinzaglio da passeggio regolabile | Justerbar line

Rindsleder, 3-fache Verstellmöglichkeit | Cow leather, 3-fold adjustable | Cuir de boeuf, 3 possibilités de réglage | Cuero de vacuno, 3 posibilidades de ajuste | Cuoio di bovina, 3 possibilità di regolazione | Okselæder, 3-trins indstilling

rot/schwarz | red/black | rouge/noir | rojo/negro | rosso/nero | rød/sort

13/200	69911		18/200	69912	
--------	-------	--	--------	-------	--

braun/schwarz | brown/black | marron/noir | marrón/negro | marrone/nero | brun/sort

13/200	207511		18/200	207512	
--------	--------	--	--------	--------	--





↕	↔*	↔.
XXS-XS	30 – 34 cm	32 – 36 cm
XS	33 – 37 cm	36 – 39 cm
XS-S	37 – 40 cm	40 – 43 cm
S	43 – 48 cm	45 – 50 cm

Geschirr LOVE

Harness | Harnais | Arnés | Pettorina | Sele

Rindsleder, Nappa/Mesh-Material, eng anliegend, gute Passform | Cow leather, Nappa/Mesh material, sits securely, snug fit | Cuir de bœuf, Nappa/Matière mesh, moulant, bon ajustement | Cuero de vacuno, Nappa/Material de rejilla, ajustado, sujeción perfecta | Cuoio di bovina, Nappa/Materiale mesh, aderente, buona vestibilità | Okselader, Nappa/Mesh materiale, tetsiddende, god pasform

rot | red | rouge | rojo | rosso | rød

XXS-XS 69913 XS 69914

XS-S 69915 S 69916

braun | brown | marron | marrón | marrone | brun

XXS-XS 207513 XS 207514

XS-S 207515 S 207516



Verstellbare Führleine ROUND & SOFT LOVE

Training leash | Laisse réglable | Correa ajustable | Guinzaglio da passeggio regolabile | Justerbar line

Rindsleder, Nappa, robuste und reißfeste Nyloneinlage, 3-fache Verstellmöglichkeit | Cow leather, Nappa, strong and resistant nylon rope inside, 3-fold adjustable | Cuir de bœuf, Nappa, garniture en nylon robuste et anti-déchirure, 3 possibilités de réglage | Cuero de vacuno, Napa, almohadilla de nylon fuerte y resistente, 3 posibilidades de ajuste | Cuoio di bovina, Nappa, rinforzo in nylon robusto e antistrappo, 3 possibilità di regolazione | Okselader, Nappa, robust og rivefast nylon-indlæg, 3-trins indstilling

rot | red | rouge | rojo | rosso | rød

6/200 69917

braun | brown | marron | marrón | marrone | brun

6/200 207517



Unvergleichlicher Tragekomfort für das Tier dank aufwendiger Verarbeitung auch an der Unterseite.
Incomparable wearing comfort for the animal thanks to elaborate also on the underside.



Alle Artikel sind auch kombinierbar mit SWISS und MAGIC STAR.
All articles can also be combined with SWISS and MAGIC STAR.



Die Herzen werden in der Bielefelder Manufaktur in aufwendiger Handarbeit einzeln eingefasst und vernäht.
The hearts are individually edged and sewn by hand in the Bielefeld factory.

Aufeinander abgestimmtes Gesamt-Sortiment aus Halsbändern, Geschirren & Leinen.
Coordinated complete assortment of Collars, Harnesses & Leashes.

LOVE

Das verwendete Rindsleder besticht durch seine Stabilität und einen kräftigen Griff. Die auffälligen Herzen werden in der Bielefelder Manufaktur in aufwendiger Handarbeit einzeln eingefasst und vernäht. Neben seiner wunderschönen Optik zeichnet sich das Halsband LOVE durch besonderen Tragekomfort aus. Es wird für ein extra anschmiegsames Gefühl am Hundehals mit weichem Rindnappaleder unterlegt.

The cowhide leather used impresses with its stability and strong feel. The eye-catching hearts are individually edged and sewn by hand in the Bielefeld factory. In addition to its beautiful appearance, the LOVE collar is particularly comfortable to wear. It is lined with soft cowhide nappa leather for an extra cuddly feeling on the dog's neck.



MADE
IN
GERMANY



■	⇒	↔	↔
32	XS	25 – 28 cm	4,4 cm
37	XS-S	29 – 33 cm	4,9 cm
42	S	33 – 39 cm	6,0 cm
47	S-M	37 – 43 cm	6,0 cm
52	M	41 – 48 cm	6,0 cm

Windhundhalsband LOVE

Greyhound collar | Collier de lévrier | Collar para galgo | Collare levriero | Vindhund-halsbånd

Rindsleder | Cow leather | Cuir de boeuf | Cuero de vacuno | Cuoio di bovina | Okseleder

rot/schwarz | red/black | rouge/noir | rojo/negro | rosso/nero | rød/sort

32	69406		37	69407	
42	69401		47	69402	
52	69408				

braun/schwarz | brown/black | marron/noir | marrón/negro | marrone/nero | brun/sort

32	207495		37	207496	
42	207497		47	207498	
52	207499				



12/Clipstrip



MADE
IN
GERMANY

Kotbeutelspender LOVE

Waste bag dispenser | Distributeur de sac sanitaire | Dispensador de bolsas para excrementos | Distributore di sacchetti per escrementi | Lorteposeautomat

Rindsleder, Nappa, mit praktischem Ringkarabiner zur variablen Befestigung, befüllbar mit handelsüblichen Kotbeutel-Rollen (1 Rolle bereits im Lieferumfang enthalten) | Cow leather, Nappa, features a practical ring clasp for flexible attachment, can be filled with standard rolls of dog waste bags (1 roll included in delivery) | Cuir de boeuf, Nappa, avec mousqueton pratique pour fixation variable, peut être rempli avec des rouleaux de sacs à excréments standard (1 rouleau inclus dans la livraison) | Cuero de vacuno, Napa, con práctico mosquetón para fijar a medida, se rellena con rollos de bolsas para excrementos (1 rollo ya incluido en la entrega) | Cuoio di bovina, Nappa, con pratico moschettone ad anello per fissaggio regolabile, può essere riempito con i normali rotoli di sacchetto per gli escrementi (1 rotolo compreso nella fornitura) | Okseleder, Nappa, med praktisk ringformede karabiner til variabel fastgørelse, kan fyldes med standard hundepose-ruller (1 rulle allerede inkluderet)

Clipstrip

69410

rot | red | rouge | rojo | rosso | rød

69409

braun | brown | marron | marrón | marrone | brun

207522

■	95 x 12 cm		12/Clipstrip
	10 x 5 cm		6 Stck. pcs.





Schlüsselanhänger LOVE

Keychain | Porte-clés | Llaveró | Portachiavi | Nøglering

Rindsleder, mit Schlüsselring | Cowhide leather, with key ring | Cuir de bœuf, avec anneau pour clés | Piel de vaca, con llaveró | In pelle di vacchetta, con anello portachiavi | Okseleder, med nøglering

rot | red | rouge | rojo | rosso | rød

4,8 cm 69994

III
6 Stck. | pcs.



Anhänger Hundemarken-Etui LOVE

Dog Tag Case Pendant | Pendentif Étui pour marques de chien | Colgante Estuche Etiqueta de Perro | Ciondolo a forma di medaglietta per cani | Vedhæng til hundetagsøske

Rindsleder, für Adress- und Steuermarken, schützt die Marke und verhindert Klimpern, mit Schlüsselring | Cowhide leather, for address and tax tags, protects the stamp and prevents jingling, with key ring | Cuir de bœuf, pour timbres-adresses et timbres fiscaux, protège le timbre et empêche le tintement, avec anneau pour clés | Piel de vaca, para sellos de direcciones e impuestos, protege el sello y evita el tintineo, con llaveró | In pelle di vacchetta, per timbri di indirizzo e fiscali, protegge il timbro e impedisce il tintinnio, con anello portachiavi | Okseleder, til adresse- og skattefrimærker, beskytter frimærket og forhindrer klirren, med nøglering

S 69992 M 69993

braun | brown | marron | marrón | marrone | brun

S 207518 M 207520

**KEIN
»KLIMPERN«
MEHR**
No more »jingling«!

MADE
IN
GERMANY

⇒	Ø	III
S	4,3 cm	6 Stck. pcs.
M	4,8 cm	6 Stck. pcs.





Deutschlands feinste Lederprodukte

— *Fair Life, Fair Leather* —

Dieses Premiumleder stammt von einem vom Internationalen Verband der Naturtextilwirtschaft (IVN) zertifizierten Lieferanten und garantiert ein Höchstmaß an Qualität und Ökologie. Es stammt ausschließlich von süddeutschen Rindern, die unter optimalen Bedingungen gehalten werden. Kurze Transportwege zu lokalen Betrieben sorgen für einen möglichst geringen CO₂-Fußabdruck und mehr Tierwohl.

This premium leather has been certified by the International Association of the Natural Textile Industry (IVN) and guarantees the highest level of quality and ecology. It comes exclusively from southern German cattle that are kept under optimal conditions. Short transport routes to local tanneries keep the CO₂ footprint of the hides as low as possible



Fair Life, Fair Leather

Höchstmaß an Qualität und Ökologie

NATURLEDER IVN ZERTIFIZIERT ist ein Standard für ökofreundliches Leder in Europa, der alle Produktionsetappen umfasst. Dies stärkt die Verbrauchersicherheit, da die Grenzwerte für Rückstände hier strenger sind als die gesetzlichen. Im Rahmen dieses Standards wird das fertige Leder zudem nach speziell für Leder erarbeiteten Qualitätsanforderungen wie beispielsweise Reibecktheit und Zugfestigkeit geprüft.

Garantiert frei von Schadstoffen - kompostierbar

Das Leder ist nachweislich frei von Schadstoffen und Chemikalien, die für Tier, Mensch und Umwelt schädlich sein könnten. Es ist hautfreundlich und antiallergen und darüber hinaus kreislauffähig. Das bedeutet, dass das Leder nach seiner Nutzung kompostiert, recycelt oder verwertet werden kann.

NATURLEDER IVN ZERTIFIZIERT

Der Internationale Verband der Naturtextilwirtschaft e.V. ist einer der führenden Zusammenschlüsse von Unternehmen, die sich der Herstellung von einwandfreien und hochwertigen Naturtextilien nach strengsten ökologischen und sozialen Richtlinien verschrieben haben. Auch für Leder hat der IVN einen Standard entwickelt, der für ein hohes technisches und ökologisches Niveau steht. Hierbei werden alle Herstellungsschritte bis hin zum fertigen Leder berücksichtigt und unter verschiedenen Aspekten wie Umweltbelastung, Gesundheit, aber auch Entsorgung und Recyclingfähigkeit beleuchtet.



Kurze Lieferwege und Herkunftsnachweis

Das verwendete Echtleder stammt ausschließlich von süddeutschen Rindern, die unter optimalen Bedingungen gehalten werden. Lückenlos dokumentierte Lieferketten mit kurzen Transportwegen und die Weiterverarbeitung in lokalen Gerbereien geben uns die Gewissheit, dass wir genau nachvollziehen können, woher unser Leder stammt und unter welchen Bedingungen es produziert wurde.

CO₂ Klimaneutral

Im April 2022 hat sich HUNTER das Ziel gesetzt, unter Berücksichtigung der Scopes 1 bis 3 bis zum Jahr 2030 am gesamten Standort in Bielefeld klimaneutral zu wirtschaften. Daher legen wir größten Fokus darauf, unseren CO₂ Fußabdruck so gering wie möglich zu halten und immer weiter zu minimieren. Kurze Transportwege innerhalb der Lieferkette sind daher unabdingbar. Das hier verwendete Leder stammt ohne Ausnahme von Rindern aus Süddeutschland, erzeugt in dort ansässigen Gerbereien. Verwendet werden ausschließlich frische, nicht konservierte Häute. Die weitere Verarbeitung zum fertigen Produkt findet in Bielefeld, im Herzen Deutschlands statt.

Komfortables Tragegefühl

Die auffallend geschmeidige Haptik des Rindnappa-Leders spricht für sich selbst. Einmal angefasst, möchte man es gar nicht mehr aus der Hand legen. In Verbindung mit der aufwändigen Weiterverarbeitung in der HUNTER Manufaktur werden die Produkte der Serie CANADIAN UP zu echten Hals- und Handschmeichlern. In zahlreichen Produktionsschritten wird das größte Augenmerk darauf gelegt, durch sorgfältig gesetzte Nähte, umgeschlagene Kanten und polsternde Einlagen ein optimales Tragegefühl für den Hund zu erreichen. Am Ende schmiegen sich Halsband oder Leine warm und weich an den empfindlichen Hundehals oder in die Hand von Herrchen und Frauchen.

Qualitätsprodukt mit kürzesten Lieferwegen

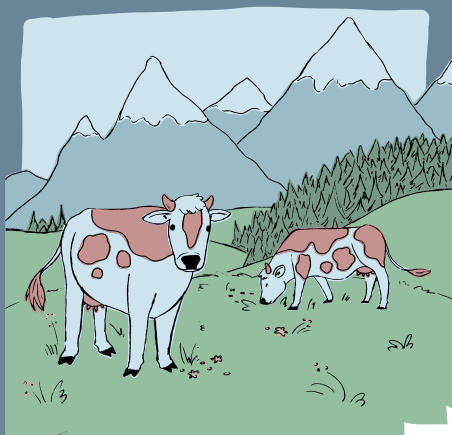

Das verwendete Naturleder stammt ausschließlich von süddeutschen Rindern, die unter optimalen Bedingungen gehalten werden.

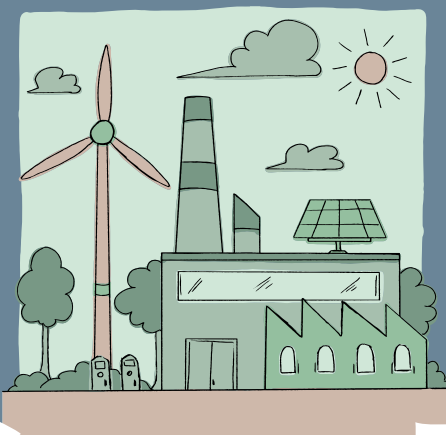

Die Häute werden in modernsten lokalen Gerbereien in Deutschland mit innovativen und ressourcenschonenden Verfahren weiterverarbeitet.



Die erfahrenen Lederspezialist:innen der HUNTER-Manufaktur in Bielefeld verarbeiten die Rohwaren zu langlebigen und reparablen Halsbändern, Leinen und Geschirren weiter.

Soziale Verantwortung

Die soziale Verantwortung eines Unternehmens bezieht sich auf dessen Verpflichtung, ethische Gesichtspunkte bei seinen Entscheidungen und Handlungen zu berücksichtigen. Dazu gehören beispielsweise der Schutz der Menschenrechte, die Förderung von Umwelt- und Arbeitsschutzstandards, die Einhaltung von Gesetzen und Vorschriften, der Umgang mit Mitarbeitern und der Beitrag zur Entwicklung der Gesellschaft. Die Richtlinien für NATURLEDER IVN ZERTIFIZIERTE Betriebe bilden nicht nur in ökologischer, sondern auch in sozial verantwortlicher Hinsicht die gesamte Produktionskette ab. Die verpflichtende Einhaltung von Sozialstandards gemäß der Internationalen Organisation für Arbeit sorgen für eine in jedem Aspekt nachhaltige Lederherstellung.

Chromfreie Gerbung

Bei HUNTER wird ausnahmslos Leder verarbeitet, das höchste Ansprüche erfüllt und nachhaltig innovativ hergestellt wird. Als Ergebnis eines intensiven Entwicklungsprozesses mit unseren langjährigen Partnern ist es uns gelungen, zu 100% auf Chromgerbung zu verzichten. Die rein pflanzenbasierten oder synthetischen Kombinationsgerbverfahren sind besonders ressourcen- und umweltschonend.

Hergestellt in modernsten lokalen Gerbereien in Deutschland

Insbesondere bei der Lederherstellung lassen sich hohe Ansprüche an Qualität und Ökologie nur auf höchstem technischen Niveau miteinander in Einklang bringen. So wird in dem ausgewählten Betrieb, der dieses exquisite Leder herstellt, auf innovative Methoden gesetzt, um eine ressourcenschonende Produktion zu gewährleisten. Die deutsche Gerberei ist zertifiziert nach ISO 9001:2015 und „gold-rated“ nach LWG-Standards. Hier wird energieeffizient produziert und der Corporate Carbon Footprint nach Maßgabe des ECO2L-Programms berechnet.



Direkt an den POS und schließlich zum Verbraucher – für lange Freude am Produkt - bei Mensch und Tier!

Mix and Match

Hier ist für jeden Vierbeiner etwas dabei, egal ob groß, klein, lang- oder kurzhaarig, Geschirr- oder Halsbandträger. Die Serie CANADIAN UP kombiniert verschiedenste Artikel zu einer tollen Auswahl an Halsbändern, Geschirren und Leinen. Eines aber haben alle diese erstklassigen Produkte gemein: die sorgfältige Verarbeitung und das auffallend weiche Rindsleder. So lassen sie sich auch wunderbar je nach Geschmack oder Stimmung miteinander ergänzen oder austauschen.

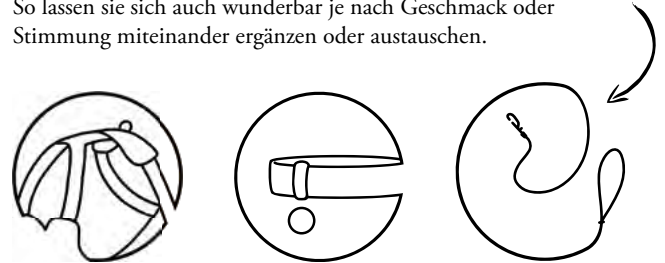

Langlebigkeit

Lederprodukte aus der HUNTER-Manufaktur sind keine Fast-Fashion Artikel, sondern langlebig und reparabel. Leder ist das wohl älteste Recyclingprodukt der Welt. Es ist ein wunderschöner natürlicher Werkstoff, der Emotionen weckt und durch Nutzung nur schöner und aussagekräftiger wird, sodass man sich auch noch nach Jahren des Gebrauchs daran erfreuen kann.

Ressourcenschonende Verarbeitung

Ressourcen sparende Prozesse sind in NATURLEDER IVN ZERTIFIZIERTEN Betrieben obligatorisch. Unser Leder wird in einer energieautarken Gerberei hergestellt, die ihren Strombedarf weitestgehend durch erneuerbare Energiequellen abdeckt. Das benötigte Wasser wird hier gebraucht und nicht verbraucht. Innerhalb eines geschlossenen Wasserkreislaufs wird es immer wieder gereinigt, aufbereitet und erneut genutzt.

Auf einen Blick:

- ✓ Das Leder stammt von süddeutschen Rindern
- ✓ Ressourcenschonende Weiterverarbeitung in modernsten deutschen Gerbereien vor Ort
- ✓ Vegetabile Gerbung
- ✓ Kurze Lieferwege
- ✓ Das Leder ist frei von Schadstoffen - chromfreie Gerbung
- ✓ Das Leder ist nach seiner Nutzung kompostierbar
- ✓ Das Leder ist besonders weich und ein echtes haptisches Erlebnis
- ✓ Beste Weiterverarbeitung in der HUNTER Manufaktur in Bielefeld

Fair Life, Fair Leather

Highest level of quality and ecology

NATURLEDER IVN ZERTIFIZIERT is a standard for eco-friendly leather in Europe, which covers all stages of production. This strengthens consumer safety as the limits for residues here are stricter than the legal ones. Under this standard, the finished leather is also tested according to quality requirements specifically developed for leather, such as rub resistance and tensile strength.

Guaranteed free of harmful substances - compostable

The leather is proven to be free of pollutants and chemicals, that could be harmful to animals, humans or the environment. It is skin-friendly and anti-allergenic and is also recyclable. This means that the leather can be composted after use, reused or recovered.

IVN-certified natural leather

The International Association of the Natural Textile Industry (IVN) is one of the leading associations of companies dedicated to the production of flawless, high-quality natural textiles in accordance with the strictest ecological and social guidelines. The IVN has also developed a standard for leather that stands for a high technical and ecological level. All manufacturing steps up to the finished leather are taken into account and examined under various aspects such as environmental impact, health, but also disposal and recyclability.



Short delivery routes and proof of origin

The real leather we use comes exclusively from southern German cattle kept under optimal conditions. Fully documented supply chains with short transport routes and further processing in local tanneries give us the certainty that we can trace exactly where our leather comes from and under what conditions it was produced.

CO₂ Footprint

In April 2022, HUNTER set itself the goal of operating climate-neutrally at the entire site in Bielefeld by 2030, taking into account Scopes 1 to 3. Therefore, we place the greatest focus on keeping our carbon footprint as small as possible and to minimise it further. Short transport routes within the supply chain are therefore indispensable. The leather used here comes without exception from cattle from southern Germany, produced in local tanneries. Only fresh, unpreserved hides are used. Further processing into the finished product takes place in Bielefeld, in the heart of Germany.

Comfortable to wear

The strikingly supple feel of the cowhide nappa leather speaks for itself. Once you have touched it, you won't want to put it down. In combination with the elaborate processing in the HUNTER manufactory, the products of the CANADIAN UP series become real neck and hand caressers. In numerous production steps, the greatest attention is paid to achieving an optimal wearing feeling for the dog through carefully placed seams, folded edges and cushioning inserts. In the end, the collar or leash nestles warmly and softly against the sensitive dog's neck or in the hand of the owner.

VEGETABLE TANNED - Leather comes from NATURAL LEATHER certified suppliers - Ecologically & socially responsible manufactured - free of harmful substances. Made in Germany

Quality product with shortest delivery routes

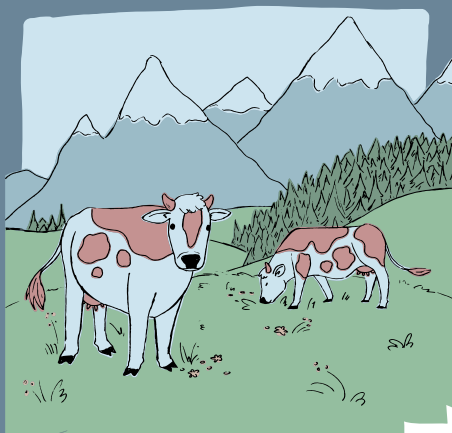

The natural leather used comes exclusively from southern German cattle kept under optimal conditions.

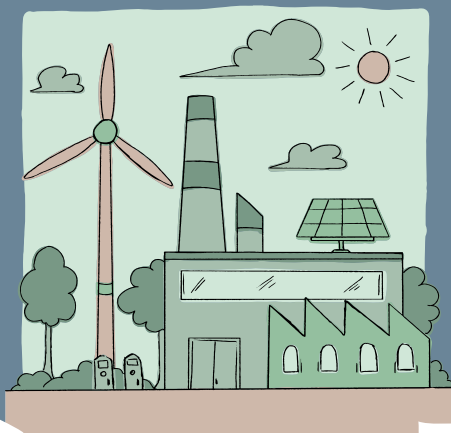

The hides are processed in the most modern local tanneries in Germany using innovative and resource-saving methods.



The experienced leather specialists at HUNTER-Manufactory in Bielefeld further process the raw materials into durable and repairable collars, leashes and harnesses.

Social responsibility

A company's social responsibility refers to its obligation to take ethical considerations into account in its decisions and actions. This includes, for example, the protection of human rights, the promotion of environmental and occupational health and safety standards, compliance with laws and regulations, the treatment of employees and the contribution to the development of society. The guidelines for IVN-certified natural leathers map the entire production chain not only in ecological but also in socially responsible terms. Mandatory compliance with social standards according to the International Labour Organisation ensure sustainable leather in every aspect

Chrome-free tanning

HUNTER only uses leather that meets the highest standards and is produced in a sustainable and innovative way. As a result of an intensive development process with our long-standing partners, we have succeeded in doing 100% without chrome tanning. The purely plant-based or synthetic combination tanning processes are particularly resource and environmentally friendly.

Manufactured in state-of-the-art local tanneries in Germany

In leather production in particular, high standards of quality and ecology can only be reconciled at the highest technical level. Thus, the selected company that produces this exquisite leather relies on innovative methods to ensure resource-saving production. The German tannery is certified according to ISO 9001:2015 and "gold-rated" according to LWG standards. Here, production is energy-efficient and the corporate carbon footprint is calculated according to the ECO2L programme.



Mix and Match

Here is something for every four-legged friend, whether large, small, long- or short-haired, harness or collar wearer. The CANADIAN UP series combines a wide variety of items to create a great selection of collars, harnesses and leashes. But all these first-class products have one thing in common: the careful workmanship and the strikingly soft natural leather. So they can also be wonderfully complemented or exchanged with each other depending on taste or mood.

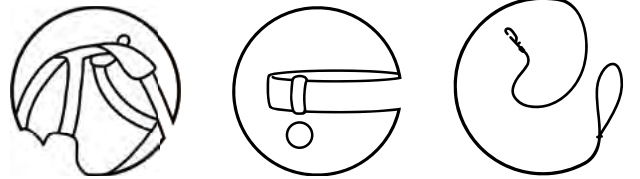

Durability

Leather products from the HUNTER manufactory are not fast-fashion items, but durable and repairable. Leather is probably the oldest recycled product in the world. It is a beautiful natural material that awakens emotions and only becomes more beautiful and expressive through use, so that you can still enjoy it after years of use.

Resource-saving processing

Resource-saving processes are mandatory in IVN-certified factories. Our leather is produced in an energy self-sufficient tannery that covers its electricity needs as far as possible with renewable energy sources. The water required is used here and not consumed. Within a closed water cycle, it is repeatedly cleaned, treated and reused.

At a glance:

- ✓ The leather comes from southern German cattle
- ✓ Resource-saving processing in modern local German tanneries
- ✓ Vegetable tanning
- ✓ Short delivery routes
- ✓ The leather is free of harmful substances - Chrome-free tanning
- ✓ The leather is compostable after use
- ✓ The leather is particularly soft and a real haptic experience
- ✓ Best finishing in the HUNTER Manufaktur in Bielefeld, Germany



Directly to the POS and finally to the consumer - for long-lasting enjoyment of the product - for people and animals!



MADE
IN
GERMANY



№	↗	↔	∅
32	XS	24 – 27 cm	6 mm
37	XS-S	30 – 33 cm	6 mm
40	S	33 – 37 cm	8 mm
45	S-M	38 – 42 cm	8 mm
50	M	41 – 46 cm	10 mm
55	M-L	46 – 51 cm	10 mm
60	L	51 – 56 cm	10 mm

Halsband ROUND & SOFT CANADIAN UP

Collar | Collier | Collar | Collare | Halsbånd

Rindsleder, Nappa, besonders weich, robuste und reißfeste Nyloneinlage | Cow leather, Nappa, extra soft, strong and resistant nylon rope inside | Cuir de bœuf, Nappa, extra souple, garniture en nylon robuste et anti-déchirure | Cuero de vacuno, Napa, extrasuave, almohadilla de nylon fuerte y resistente | Cuoio di bovina, Nappa, extra morbida, rinforzo in nylon robusto e antistrappo | Okselader, Nappa, ekstra blødt, robust og rivefast nylon-indlæg

cognac | cognac | cognac | coñac | cognac | cognac

32	200038		37	200039	
40	200040		45	200041	
50	200042		55	200043	
60	200044				
schwarz black noir negro nero sort					
32	200045		37	200046	
40	200047		45	200048	
50	200049		55	200050	
60	200051				



MADE
IN
GERMANY



↗	↔	∅
S-M	max. 40 cm	10 mm
M	max. 45 cm	10 mm
M-L	max. 50 cm	10 mm
L	max. 55 cm	10 mm
L-XL	max. 60 cm	10 mm

Dressurhalsung ROUND & SOFT CANADIAN UP

Training collar | Collier de dressage | Collar de adiestramiento | Collare da addestramento | Dressurhalsbånd

Rindsleder, Nappa, besonders weich, robuste und reißfeste Nyloneinlage, durch Stoppring stufenlos verstellbar | Cow leather, Nappa, extra soft, strong and resistant nylon rope inside, with stop-ring individually adjustable | Cuir de bœuf, Nappa, extra souple, garniture en nylon robuste et anti-déchirure, réglable en continu avec anneau d'arrêt | Cuero de vacuno, Napa, extrasuave, almohadilla de nylon fuerte y resistente, regulable mediante anilla de bloqueo | Cuoio di bovina, Nappa, extra morbida, rinforzo in nylon robusto e antistrappo, regolabile in continuo tramite anello di arresto | Okselader, Nappa, ekstra blødt, robust og rivefast nylon-indlæg, trinløs indstilling via stopring

cognac | cognac | cognac | coñac | cognac | cognac

S-M	200016		M	200017	
M-L	200018		L	200019	
L-XL	200020				
schwarz black noir negro nero sort					
S-M	200021		M	200022	
M-L	200023		L	200024	
L-XL	200025				



⇒ XXS-XS – S/1

⇒ S2 – S-M



⇒	↔	↔
XXS-XS	32 – 38 cm	6/14 mm
XS-S	37 – 43 cm	6/14 mm
S/1	42 – 48 cm	6/14 mm
S/2	45 – 51 cm	8/18 mm
S-M	50 – 56 cm	8/18 mm

Geschirr ROUND & SOFT CANADIAN UP

Harness | Harnais | Arnés | Pettorina | Sele

Rindsleder, Nappa, besonders weich, robuste und reißfeste Nyloneinlage, für Kleinhunde | Cow leather, Nappa, extra soft, strong and resistant nylon rope inside, for small dogs | Cuir de bœuf, Nappa, extra souple, garniture en nylon robuste et anti-déchirure, pour petits chiens | Cuero de vacuno, Napa, extrasuave, almohadilla de nylon fuerte y resistente, para perros pequeños | Cuoio di bovina, Nappa, extra morbida, rinforzo in nylon robusto e antistrappo, per cani de piccola taglia | Okselader, Nappa, ekstra blødt, robust og rivefast nylon-indlæg, for små hunde

cognac | cognac | cognac | coñac | cognac | cognac

XXS-XS 200000 XS-S 200001

S/1 200002 S/2 200003

S-M 200004

schwarz | black | noir | negro | nero | sort

XXS-XS 200005 XS-S 200006

S/1 200007 S/2 200008

S-M 200009



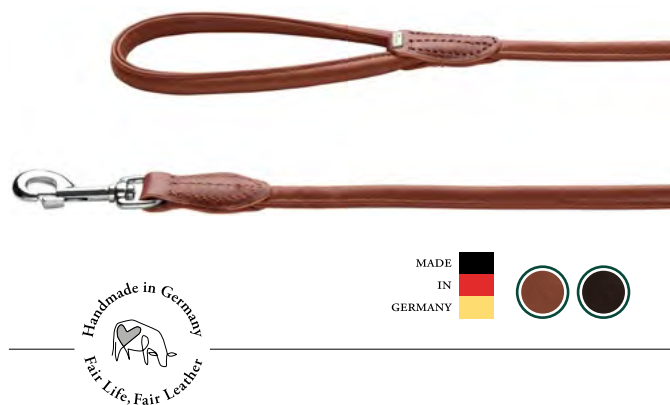

Führleine ROUND & SOFT CANADIAN UP

Leash | Laisse | Correa | Guinzaglio da passeggio | Line

Rindsleder, Nappa, besonders weich, robuste und reißfeste Nyloneinlage | *Cow leather, Nappa, extra soft, strong and resistant nylon rope inside* | Cuir de bœuf, Nappa, extra souple, garniture en nylon robuste et anti-déchirure | *Cuero de vacuno, Napa, extrasuave, almohadilla de nylon fuerte y resistente* | Cuoio di bovina, Nappa, extra morbida, rinforzo in nylon robusto e antistrappo | *Okselader, Nappa, ekstra blødt, robust og rivefast nylon-indlæg*

cognac | cognac | cognac | coñac | cognac | cognac

6/110 200052 8/100 200053

10/100 200054

schwarz | black | noir | negro | nero | sort

6/110 200055 8/100 200056

10/100 200057



Verstellbare Führleine ROUND & SOFT CANADIAN UP

Training leash | Laisse réglable | Correa ajustable | Guinzaglio da passeggio regolabile | Justerbar line

Rindsleder, Nappa, besonders weich, 3-fache Verstellmöglichkeit, robuste und reißfeste Nyloneinlage | *Cow leather, Nappa, extra soft, 3-fold adjustable, strong and resistant nylon rope inside* | Cuir de bœuf, Nappa, extra souple, 3 possibilités de réglage, garniture en nylon robuste et anti-déchirure | *Cuero de vacuno, Napa, extrasuave, 3 posibilidades de ajuste, almohadilla de nylon fuerte y resistente* | Cuoio di bovina, Nappa, extra morbida, 3 possibilità di regolazione, rinforzo in nylon robusto e antistrappo | *Okselader, Nappa, ekstra blødt, 3-trins indstilling, robust og rivefast nylon-indlæg*

cognac | cognac | cognac | coñac | cognac | cognac

6/200 200066 8/200 200067

10/200 200068 14/200 200069

schwarz | black | noir | negro | nero | sort

6/200 200070 8/200 200071

10/200 200072 14/200 200073

XL
14/200 ml





Retriever-Leine ROUND & SOFT CANADIAN UP

Retriever leash | Laisse pour retriever | Correa para retriever | Guinzaglio retriever | Retrieverline

Rindsleder, Nappa, besonders weich, robuste und reißfeste Nylon-einlage, Halsung durch Stoppring und Schieber stufenlos verstellbar | Cow leather, Nappa, extra soft, strong and resistant nylon rope inside, training collar with stop-ring and slide individually adjustable | Cuir de bœuf, Nappa, extra souple, garniture en nylon robuste et anti-déchirure, collier réglable en continu avec anneau d'arrêt et passant | Cuero de vacuno, Napa, extrasuave, almohadilla de nylon fuerte y resistente, collar regulable mediante anilla y pasador | Cuoio di bovina, Nappa, extra morbida, rinforzo in nylon robusto e antistrappo, collare regolabile in continuo tramite anello di arresto e fibbia | Okseleder, Nappa, ekstra blødt, robust og rivefast nylon-indlæg, trinløs justering af halsbånd via stopring og glider

cognac | cognac | cognac | coñac | cognac | cognac

10/120 200058 

schwarz | black | noir | negro | nero | sort

10/120 200059 





№	↗	↔	↔
40	S	29 – 35 cm	1,8 cm
45	S	33 – 39 cm	2,8 cm
50	S-M	37 – 43 cm	2,8 cm
55	M	42 – 48 cm	3,5 cm
60	M-L	46 – 52 cm	3,5 cm
65	L	50 – 56 cm	3,5 cm

Halsband CANADIAN UP

Collar | Collier | Collar | Collare | Halsbånd

Rindsleder, Nappa, besonders weich | *Cow leather, Nappa, extra soft* | Cuir de bœuf, Nappa, extra souple | *Cuero de vacuno, Napa, extrasuave* | Cuoio di bovina, Nappa, extra morbida | *Okselader, Nappa, ekstra blødt*

cognac/schwarz | cognac/black | cognac/noir | coñac/negro | cognac/nero | cognac/sort

40	200026		45	200028	
50	200030		55	200032	
60	200034		65	200036	
schwarz/cognac black/cognac noir/cognac negro/coñac nero/cognac sort/cognac					
40	200027		45	200029	
50	200031		55	200033	
60	200035		65	200037	



↗	↔	↔
XXS-XS	16 – 22 cm	1,0 cm
S/1	25 – 35 cm	1,5 cm
S/2	28 – 36 cm	1,5 cm

Halsung CANADIAN UP

Collar | Collier | Collar | Collare | Halsbånd

Rindsleder, Nappa, besonders weich, mit besonders kleinem D-Ring und Schnalle, für Kleinhunde | *Cow leather, Nappa, extra soft, with really small D-ring and clasp, for small dogs* | Cuir de bœuf, Nappa, extra souple, avec un anneau D et une boucle particulièrement petits, pour petits chiens | *Cuero de vacuno, Napa, extrasuave, con anilla en forma de D y hebilla especialmente pequeñas, para perros pequeños* | Cuoio di bovina, Nappa, extra morbida, con un anello a D particolarmente piccolo e fibbia, per cani di piccola taglia | *Okselader, Nappa, ekstra blødt, med meget lille D-ring og spænde, for små hunde*

cognac | cognac | cognac | coñac | cognac | cognac

XXS-XS	200010		S/1	200011	
S/2	200012				
schwarz black noir negro nero sort					
XXS-XS	200013		S/1	200014	
S/2	200015				





Verstellbare Führleine CANADIAN UP

Training leash | Laisse réglable | Correa ajustable | Guinzaglio da passeggio regolabile | Justerbar line

Rindsleder, Nappa, besonders weich, 3-fache Verstellmöglichkeit | *Cow leather, Nappa, extra soft, 3-fold adjustable* | Cuir de bœuf, Nappa, extra souple, 3 possibilités de réglage | *Cuero de vacuno, Napa, extrasuave, 3 posibilidades de ajuste* | Cuoio di bovina, Nappa, extra morbida, 3 possibilità di regolazione | *Okselader, Nappa, ekstra blødt, 3-trins indstilling*
cognac | cognac | cognac | coñac | cognac | cognac

8/200 200064

schwarz | black | noir | negro | nero | sort

8/200 200065

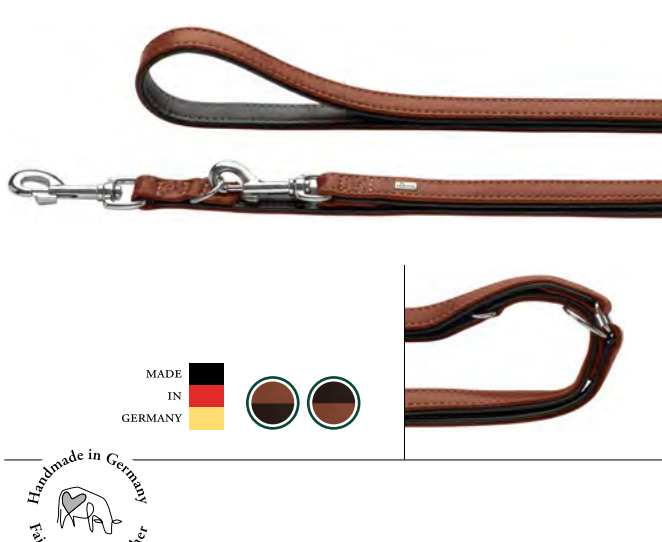

Verstellbare Führleine CANADIAN UP

Training leash | Laisse réglable | Correa ajustable | Guinzaglio da passeggio regolabile | Justerbar line

Rindsleder, Nappa, besonders weich, 3-fache Verstellmöglichkeit | *Cow leather, Nappa, extra soft, 3-fold adjustable* | Cuir de bœuf, Nappa, extra souple, 3 possibilités de réglage | *Cuero de vacuno, Napa, extrasuave, 3 posibilidades de ajuste* | Cuoio di bovina, Nappa, extra morbida, 3 possibilità di regolazione | *Okselader, Nappa, ekstra blødt, 3-trins indstilling*
cognac/schwarz | cognac/black | cognac/noir | coñac/negro | cognac/nero | cognac/sort

15/200 200060 20/200 200062

schwarz/cognac | black/cognac | noir/cognac | negro/coñac | nero/cognac | sort/cognac

15/200 200061 20/200 200063





MADE
IN
GERMANY



Handmade in Germany
Fair Life, Fair Leather

№	⇒	⇔	↔
32	XS	24 – 27 cm	2,7 cm
37	XS-S	28 – 33 cm	3,0 cm
42	S	33 – 37 cm	3,0 cm
47	S-M	37 – 42 cm	3,5 cm
50	S-M	35 – 42 cm	4,0 cm
55	M	40 – 48 cm	4,0 cm
60	M-L	45 – 52 cm	4,0 cm
65	L	50 – 58 cm	4,0 cm

Halsband MÜNCHEN

Collar | Collier | Collar | Collare | Halsbånd

Rindsleder, Nappa, besonders weich | *Cow leather, Nappa, extra soft* |
Cuir de bœuf, Nappa, extra souple | *Cuero de vacuno, Napa, extrasuave* |
| *Cuoio di bovina, Nappa, extra morbida* | *Okselæder, Nappa, ekstra blødt*

grün/cognac | green/cognac | vert/cognac | verde/coñac | verde/cognac | grön/
cognac

32 69373 37 69374

42 69375 47 69376

50 69377 55 69378

60 69379 65 69380

cognac/schwarz | cognac/black | cognac/noir | coñac/negro | cognac/nero |
cognac/sort

32 69385 37 69386

42 69387 47 69388

50 69389 55 69390

60 69391 65 69392



Xs

MADE
IN
GERMANY



Handmade in Germany
Fair Life, Fair Leather

№	⇒	⇔	↔
27	XXS-XS	20 – 24 cm	1,8 cm
30	XS	23 – 27 cm	1,8 cm

Halsband MÜNCHEN MINI

Collar | Collier | Collar | Collare | Halsbånd

Rindsleder, Nappa, besonders weich, für Kleinhunde | *Cow leather, Nappa, extra soft, for small dogs* |
Cuir de bœuf, Nappa, extra souple, pour petits chiens | *Cuero de vacuno, Napa, extrasuave, para perros pequeños* |
| *Cuoio di bovina, Nappa, extra morbida, per cani di piccola taglia* | *Okselæder, Nappa, ekstra blødt, for små hunde*

grün/cognac | green/cognac | vert/cognac | verde/coñac | verde/cognac | grön/
cognac

27 69371 30 69372

cognac/schwarz | cognac/black | cognac/noir | coñac/negro | cognac/nero |
cognac/sort

27 69383 30 69384





MADE
IN
GERMANY



XS

Size	Label	Length	Width
32	XS	24 – 27 cm	2,6 cm
37	XS-S	28 – 32 cm	3,0 cm
42	S	33 – 37 cm	3,0 cm

Teckel-Halsband MÜNCHEN

Dachshund collar | Collier Teckel | Collar de perro salchicha | Collare per bassotti | Dachshund halsbånd

Rindsleder, Nappa, besonders weich, ideal für Teckel geeignet | *Cow leather, Nappa, extra soft, ideally suited for dachshunds* | Cuir de bœuf, Nappa, extra souple, idéal pour les teckels | *Cuero de vacuno, Nappa, extrasuave, ideal para perros salchicha* | Cuoio di bovina, Nappa, extra morbida, ideale per i bassotti | *Okselæder, Nappa, ekstra blødt, ideel til dachshunde*

grün/cognac | green/cognac | vert/cognac | verde/coñac | verde/cognac | grøn/cognac

32 69395 37 69396

42 69397

cognac/schwarz | cognac/black | cognac/noir | coñac/negro | cognac/nero | cognac/sort

32 69398 37 69399

42 69400

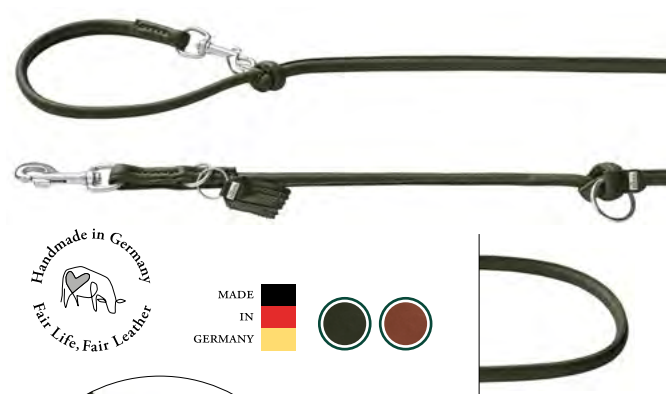

MADE
IN
GERMANY



Verstellbare Führleine ROUND MÜNCHEN

Training leash | Laisse réglable | Correa ajustable | Guinzaglio da passeggio regolabile | Justerbar line

Rindsleder, Nappa, besonders weich, 3-fache Verstellmöglichkeit, robuste und reißfeste Nyloneinlage | *Cow leather, Nappa, extra soft, 3-fold adjustable, strong and resistant nylon rope inside* | Cuir de bœuf, Nappa, extra souple, 3 possibilités de réglage, garniture en nylon robuste et anti-déchirure | *Cuero de vacuno, Nappa, extrasuave, 3 posibilidades de ajuste, almohadilla de nylon fuerte y resistente* | Cuoio di bovina, Nappa, extra morbida, 3 possibilità di regolazione, rinforzo in nylon robusto e antistrappo | *Okselæder, Nappa, ekstra blødt, 3-trins indstilling, robust og rivefast nylon-indlæg*

grün | green | vert | verde | verde | grøn

6/200 69381 8/200 203359

10/200 69382

cognac | cognac | cognac | coñac | cognac | cognac

6/200 69393 8/200 203358

10/200 69394









MADE
IN
GERMANY



Size	Symbol	Length	Width
21	XXS	14 – 18 cm	0,9 cm
24	XXS–XS	17 – 20 cm	0,9 cm
27	XXS–XS	20 – 24 cm	0,9 cm
32	XS	24 – 29 cm	1,1 cm
37	XS–S	29 – 34 cm	1,1 cm



Halsband SOHO MINI

Collar | Collier | Collar | Collare | Halsbånd

Rindsleder, Nappa, besonders weich, besonders für kleine Hunde und Welpen geeignet | Cow leather, Nappa, extra soft, especially suitable for small dogs and puppies | Cuir de bœuf, Nappa, extra souple, particulièrement adapté aux petits chiens et aux chiots | Cuero de vacuno, Napa, extrasuave, especialmente indicado para perros pequeños y cachorros | Cuoio di bovina, Nappa, extra morbida, Particolarmente indicato per cani di piccola taglia e cuccioli | Okseleder, Nappa, ekstra blødt, særligt velegnet til små hunde og hvalpe

hellrosa | light pink | rose clair | rosa pálido | rosa chiaro | lyserød

21	201791		24	201792	
27	201793		32	201794	
37	201795				

flieder-grau | lilac-grey | lilas-gris | lila-gris | lilla-grigio | lilla-grå

21	201813		24	201814	
27	201815		32	201816	
37	201817				

hellblau | light blue | bleu clair | azul claro | azzurro | lyseblå

21	201802		24	201803	
27	201804		32	201805	
37	201806				

schwarz | black | noir | negro | nero | sort

21	201780		24	201781	
27	201782		32	201783	
37	201784				

Für kleine Hunde und Welpen

— For small dogs and puppies —

Die besonders filigran gearbeitete Serie SOHO MINI eignet sich speziell für Welpen und kleine Hunde. Alle Metallbeschläge sind der schmalen Größe von Halsband, Geschirr und Leine angepasst und extra leicht. Das auffallend weiche und geschmeidige Rindsleder, das hier Verwendung findet, wird unter Einhaltung höchster ökologischer Standards hergestellt und ist garantiert frei von Schadstoffen, wie zum Beispiel Chrom.

The particularly filigree SOHO MINI series is especially suitable for puppies and small dogs. All metal fittings are adapted to the narrow size of the collar, harness and leash and are extra light. The strikingly soft and supple cowhide leather used here is manufactured in compliance with the highest ecological standards and is guaranteed free of harmful substances, such as chrome.



STEP-IN



MADE IN GERMANY



	↕	↔	↔
XXS-XS/1	28 - 34 cm	1,4 cm	
XXS-XS/2	33 - 39 cm	1,6 cm	
XS	34 - 47 cm	1,8 cm	
XS-S	37 - 50 cm	2,0 cm	

Geschirr SOHO MINI

Harness | Harnais | Arnés | Pettorina | Sele

Rindsleder, Nappa, besonders weich, besonders für kleine Hunde und Welpen geeignet | Cow leather, Nappa, extra soft, especially suitable for small dogs and puppies | Cuir de boeuf, Nappa, extra souple, particulièrement adapté aux petits chiens et aux chiots | Cuero de vacuno, Napa, extrasuave, especialmente indicado para perros pequeños y cachorros | Cuoio di bovina, Nappa, extra morbida, Particolarmente indicato per cani di piccola taglia e cuccioli | Okseleder, Nappa, ekstra blødt, særligt velegnet til små hunde og hvalpe

hellrosa | light pink | rose clair | rosa pálido | rosa chiaro | lyserød

XXS-XS/1 201796 XXS-XS/2 201797

XS 201798 XS-S 201799

flieder-grau | lilac-grey | lilas-gris | lila-gris | lilla-grigio | lilla-grå

XXS-XS/1 201818 XXS-XS/2 201819

XS 201820 XS-S 201821

hellblau | light blue | bleu clair | azul claro | azzurro | lyseblå

XXS-XS/1 201807 XXS-XS/2 201808

XS 201809 XS-S 201810

schwarz | black | noir | negro | nero | sort

XXS-XS/1 201785 XXS-XS/2 201786

XS 201787 XS-S 201788





MADE
IN
GERMANY



Size	Label	Length	Width
32	XS	24 – 27 cm	2,6 cm
37	XS-S	28 – 32 cm	2,6 cm
42	S	33 – 37 cm	3,0 cm
47	S-M	37 – 42 cm	3,5 cm

Halsband SOHO X LOVE

Collar | Collier | Collar | Collare | Halsbånd

Rindsleder, Nappa, besonders weich | *Cowhide, nappa, especially soft*
| Cuir de bœuf, nappa, particulièrement souple | *Piel de vaca, napa, especialmente suave* | Pelle bovina, nappa, particolarmente morbida | *Koskind, nappa, særligt blødt*

flieder-grau | lilac-grey | lilas-gris | lila-gris | lilla-grigio | lilla-grå

32 203807 37 203808

42 203809 47 203810

hellrosa | light pink | rose clair | rosa pálido | rosa chiaro | lyserød

32 203799 37 203800

42 203801 47 203802

hellblau | light blue | bleu clair | azul claro | azzurro | lyseblå

32 203803 37 203804

42 203805 47 203806

schwarz | black | noir | negro | nero | sort

32 203795 37 203796

42 203797 47 203798



SOHO X LOVE

Das handgefertigte Meisterwerk aus der renommierten Bielefelder Ledermanufaktur: Jedes Stück wird mit Liebe zum Detail gefertigt und veredelt, wobei kunstvoll gestaltete Herzen in aufwendiger Handarbeit eingearbeitet werden. Das Ergebnis ist nicht nur ein hochwertiges Accessoire, sondern auch ein Ausdruck von Qualität und Eleganz.

The handmade masterpiece from the renowned Bielefeld leather manufactory: Each piece is crafted and refined with attention to detail, with artistically designed hearts elaborately worked in by hand. The result is not only a high-quality accessory, but also an expression of quality and elegance.

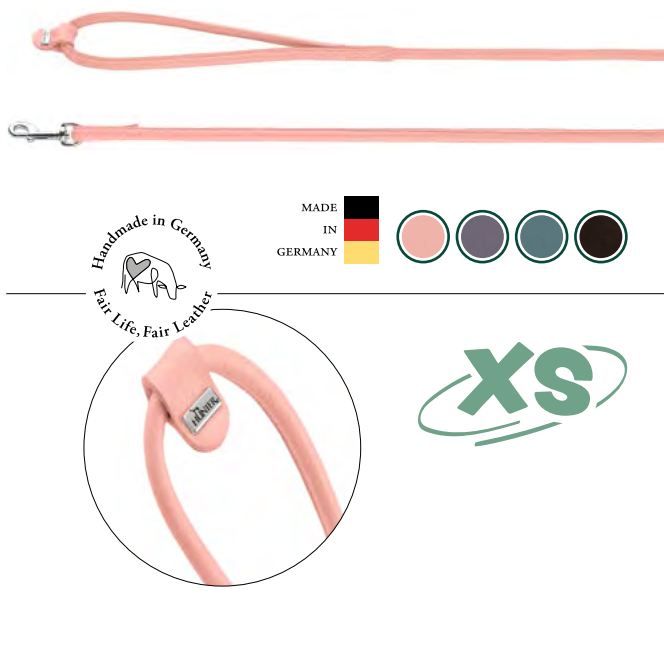

Führleine SOHO ROUND MINI

Leash | Laisse | Correa | Guinzaglio da passeggio | Line

Rindsleder, Nappa, besonders weich, robuste und reißfeste Nyloneinlage | Cow leather, Nappa, extra soft, strong and resistant nylon rope inside | Cuir de bœuf, Nappa, extra souple, garniture en nylon robuste et anti-déchirure | Cuero de vacuno, Napa, extrasuave, almohadilla de nylon fuerte y resistente | Cuoio di bovina, Nappa, extra morbida, rinforzo in nylon robusto e antistrappo | Okselæder, Nappa, ekstra blødt, robust og rivefast nylon-indlæg

hellrosa | light pink | rose clair | rosa pálido | rosa chiaro | lyserød

6/140 201800

flieder-grau | lilac-grey | lilas-gris | lila-gris | lilla-grigio | lilla-grå

6/140 201822

hellblau | light blue | bleu clair | azul claro | azzurro | lyseblå

6/140 201811

schwarz | black | noir | negro | nero | sort

6/140 201789

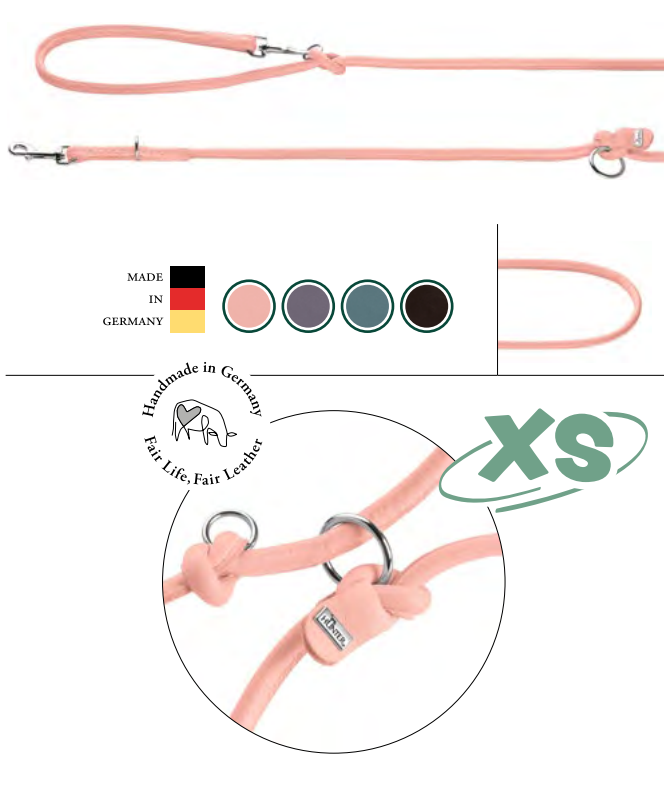

Verstellbare Führleine SOHO ROUND MINI

Training leash | Laisse réglable | Correa ajustable | Guinzaglio da passeggio regolabile | Justerbar line

Rindsleder, Nappa, besonders weich, 3-fache Verstellmöglichkeit, robuste und reißfeste Nyloneinlage | Cow leather, Nappa, extra soft, 3-fold adjustable, strong and resistant nylon rope inside | Cuir de bœuf, Nappa, extra souple, 3 possibilités de réglage, garniture en nylon robuste et anti-déchirure | Cuero de vacuno, Napa, extrasuave, 3 posibilidades de ajuste, almohadilla de nylon fuerte y resistente | Cuoio di bovina, Nappa, extra morbida, 3 possibilità di regolazione, rinforzo in nylon robusto e antistrappo | Okselæder, Nappa, ekstra blødt, 3-trins indstilling, robust og rivefast nylon-indlæg

hellrosa | light pink | rose clair | rosa pálido | rosa chiaro | lyserød

6/200 201801 8/200 203356

flieder-grau | lilac-grey | lilas-gris | lila-gris | lilla-grigio | lilla-grå

6/200 201823 8/200 203354

hellblau | light blue | bleu clair | azul claro | azzurro | lyseblå

6/200 201812 8/200 203355

schwarz | black | noir | negro | nero | sort

6/200 201790 8/200 203357

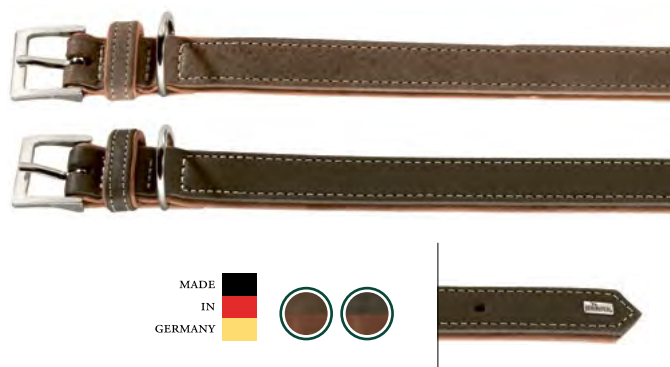

MADE
IN
GERMANY



cm	⇒	↔	↔
30	XS	21 – 25 cm	1,8 cm
35	XS-S	24 – 30 cm	1,8 cm
40	S	29 – 35 cm	1,8 cm
45	S	33 – 39 cm	2,8 cm
50	S-M	37 – 43 cm	2,8 cm
55	M	42 – 48 cm	3,5 cm
60	M-L	46 – 52 cm	3,5 cm
65	L	50 – 56 cm	3,5 cm

Halsband PORTO

Collar | Collier | Collar | Collare | Halsbånd

Rindsleder | Cow leather | Cuir de bœuf | Cuero de vacuno | Cuoio di bovina | Okselæder

tabak/cognac | tobacco/cognac | tabac/cognac | tabaco/coñac | tabacco/cognac | tobak/cognac

30 63744 35 63745

40 63746 45 63747

50 63748 55 63749

60 63750 65 63751

dunkelbraun/cognac | dark brown/cognac | marron foncé/cognac | marrón oscuro/coñac | marrone scuro/cognac | mørkebrun/cognac

30 63728 35 63729

40 63730 45 63731

50 63732 55 63733

60 63734 65 63735



MADE
IN
GERMANY



Verstellbare Führleine PORTO

Training leash | Laisse réglable | Correa ajustable | Guinzaglio da passeggio regolabile | Justerbar line

Rindsleder, 3-fache Verstellmöglichkeit | Cow leather, 3-fold adjustable | Cuir de bœuf, 3 possibilités de réglage | Cuero de vacuno, 3 posibilidades de ajuste | Cuoio di bovina, 3 possibilità di regolazione | Okselæder, 3-trins indstilling

tabak/cognac | tobacco/cognac | tabac/cognac | tabaco/coñac | tabacco/cognac | tobak/cognac

15/200 63764 20/200 63765

dunkelbraun/cognac | dark brown/cognac | marron foncé/cognac | marrón oscuro/coñac | marrone scuro/cognac | mørkebrun/cognac

15/200 63760 20/200 63761





Olivenleder

the taste of Luxtainability

Pflanzlich gegerbt

Vegetable tanned

Bei diesem pflanzlich gegerbten Premiumleder steht der Umweltschutz im Vordergrund. Aus Olivenbaumblättern, einem Nebenprodukt des Olivenanbaus, wird ein Extrakt gewonnen, welcher als Gerbstoff für dieses Leder mit Wohlfühlfaktor dient. Die Gewinnung des Gerbstoffes ist dank nachwachsender Rohstoffe sehr umweltfreundlich und bietet eine perfekte Reststoffverwertung. Dieses natürliche und nachhaltige Leder besticht durch eine angenehm weiche Haptik, eine ausgezeichnete Festnarbigkeit und einen mediterranen Duft und wird den Ansprüchen hinsichtlich Ästhetik, Zweckmäßigkeit und Funktionalität an ein hochwertiges HUNTER-Produkt »Made in Germany« gerecht.

Hinweis: Unsere Leder werden so schonend wie möglich hergestellt. Bei gefärbtem Leder kann es anfänglich zu leichten, nachlassenden Abfärbungen kommen.

Environmental protection is writ large with this vegetable tanned leather of premium quality. An extract is derived from olive tree leaves, a by-product of farming olives which serves as the tanning agent for this leather giving it a feel good factor. The extraction of the tanning agent is very environmentally-friendly thanks to renewable resources while providing perfect waste recycling. This natural and sustainable leather captivates through its pleasant feel, an excellent fullness of grain and a Mediterranean fragrance while meeting the requirements of aesthetics, expediency and practicality demanded by a quality HUNTER product »Made in Germany«.

Note: Our leather is produced as gently as possible. With a dyed leather there may be a slight discolouration.





Alu-Strong



	↔	↔
M	30 – 45 cm	1,5 cm
L	40 – 55 cm	2,5 cm
XL	45 – 65 cm	2,5 cm



□	↗	↔	↔
40	S	29 – 35 cm	1,8 cm
45	S	33 – 39 cm	2,8 cm
50	S-M	37 – 43 cm	2,8 cm
55	M	42 – 48 cm	3,5 cm
60	M-L	46 – 52 cm	3,5 cm
65	L	50 – 56 cm	3,5 cm

Halsung HUNTING ALU-STRONG

Collar | Collier | Collar | Collare | Halsbånd

Rindsleder, Nubuck, besonders weich, Steckverschluss aus Aluminium, Metall-Schieber | Cow leather, Nubuck, extra soft, buckle made of aluminum, metal slide | Cuir de bœuf, Nubuck, extra souple, fermeture à clips pratique d'aluminium, coulisseau en métal | Cuero de vacuno, Nobuck, extrasuave, cierre a presión de aluminio, pasador metálico | Cuoio di bovina, Nubuck, extra morbida, chiusura a scatto in alluminio, fibbia di metallo | Okselæder, Nubuck, ekstra blødt, kliklås af aluminium, metalspændet

oliv | olive | olive | oliva | oliva | olivenfarvet

M 63868 L 63869

XL 63870

braun | brown | marron | marrón | marrone | brun

M 63871 L 63872

XL 63873

schwarz | black | noir | negro | nero | sort

M 63874 L 63875

XL 63876

Halsband HUNTING

Collar | Collier | Collar | Collare | Halsbånd

Rindsleder, Nubuck, besonders weich | Cow leather, Nubuck, extra soft | Cuir de bœuf, Nubuck, extra souple | Cuero de vacuno, Nobuck, extrasuave | Cuoio di bovina, Nubuck, extra morbida | Okselæder, Nubuck, ekstra blødt

oliv | olive | olive | oliva | oliva | olivenfarvet

40 63879 45 63880

50 63881 55 63882

60 63883 65 63884

braun | brown | marron | marrón | marrone | brun

40 63887 45 63888

50 63889 55 63890

60 63891

schwarz | black | noir | negro | nero | sort

40 63895 45 63896

50 63897 55 63898

60 63899



⇒	↔	↔	↔
M	45 cm	58 – 79 cm	2,0 cm
L/1	50 cm	69 – 93 cm	2,5 cm
L/2	55 cm	71 – 97 cm	2,5 cm
L-XL	60 cm	77 – 110 cm	2,5 cm

Norwegergeschirr HUNTING

Norwegian harness | *Harnais norvégien* | *Arnés noruego* |
 Pettorina norvegese | *Norsk sele*

Rindsleder, Nubuk, besonders weich, mit Steckverschluss aus Aluminium, mit O-Ring (nicht eingenäht), Bauchriemen durch Metallschieber individuell verstellbar | *Cow leather, Nubuck, extra soft, pleasantly soft and light, with buckle made of aluminum, with O ring (not sewn in), stomach straps can be individually adjusted with the metal slider* | *Cuir de bœuf, Nubuck, extra souple, agréablement doux et léger, avec fermeture à clips pratique d'aluminium, avec anneau O (non cousu dans le harnais), ceinture ventrale ajustable individuellement au moyen d'un coulisseau en métal* | *Cuero de vacuno, Nobuck, extrasuave, agradablemente suave y ligero, con cierre a presión de aluminio, con anillo tórico (no cosido), correa para el abdomen regulable mediante pasador metálico* | *Cuoio di bovina, Nubuck, extra morbida, agradablemente suave y ligero, con chiusura a scatto in alluminio, con anillo tórico (no cosido), correa para el abdomen regulable mediante pasador metálico* | *Okseleder, Nubuck, ekstra blødt, dejlig blød og let, med kliklås af aluminium, med O-ring (ikke indsyet), maverem kan indstilles individuelt ved hjælp af metalelement*

braun | brown | marron | marrón | marrone | brun

M 60290 L/1 60291

L/2 60292 L-XL 60293

schwarz | black | noir | negro | nero | sort

M 60300 L/1 60301

L/2 60302 L-XL 60303



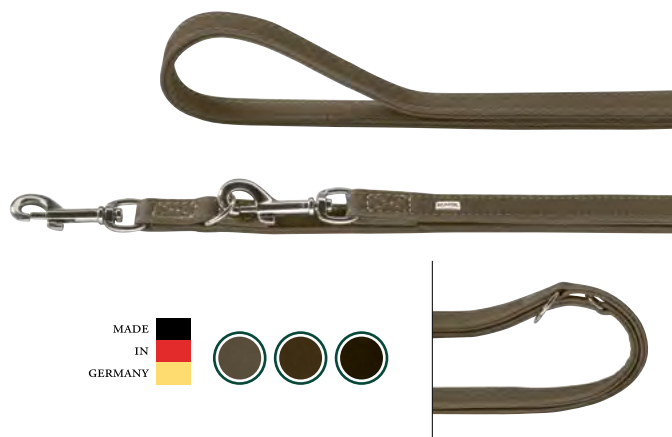

Verstellbare Führleine HUNTING

Training leash | Laisse réglable | Correa ajustable | Guinzaglio da passeggio regolabile | Justerbar line

Rindsleder, Nubuck, besonders weich, 3-fache Verstellmöglichkeit | *Cow leather, Nubuck, extra soft, 3-fold adjustable* | Cuir de bœuf, Nubuck, extra souple, 3 possibilités de réglage | *Cuero de vacuno, Nubuck, extrasuave, 3 posibilidades de ajuste* | Cuoio di bovina, Nubuck, extra morbida, 3 possibilità di regolazione | *Okselæder, Nubuck, ekstra blødt, 3-trins indstilling*

oliv | olive | olive | oliva | oliva | olivenfarvet

13/200 60225 18/200 60226

braun | brown | marron | marrón | marrone | brun

13/200 60227 18/200 60228

schwarz | black | noir | negro | nero | sort

13/200 60231 18/200 60232

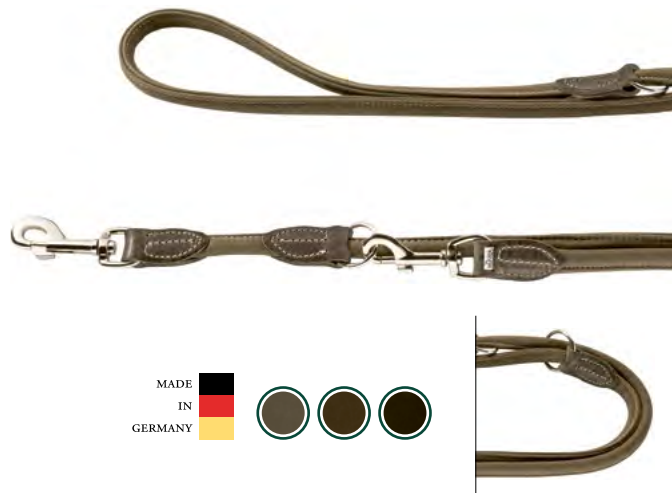

Verstellbare Führleine ROUND & SOFT HUNTING

Training leash | Laisse réglable | Correa ajustable | Guinzaglio da passeggio regolabile | Justerbar line

Rindsleder, Nubuck, besonders weich, 3-fache Verstellmöglichkeit, robuste und reißfeste Nyloneinlage | *Cow leather, Nubuck, extra soft, 3-fold adjustable, strong and resistant nylon rope inside* | Cuir de bœuf, Nubuck, extra souple, 3 possibilités de réglage, garniture en nylon robuste et anti-déchirure | *Cuero de vacuno, Nubuck, extrasuave, 3 posibilidades de ajuste, almohadilla de nylon fuerte y resistente* | Cuoio di bovina, Nubuck, extra morbida, 3 possibilità di regolazione, rinforzo in nylon robusto e antistrappo | *Okselæder, Nubuck, ekstra blødt, 3-trins indstilling, robust og rivefast nylon-indlæg*

oliv | olive | olive | oliva | oliva | olivenfarvet

6/200 63901 10/200 63904

braun | brown | marron | marrón | marrone | brun

6/200 63902 10/200 63905

schwarz | black | noir | negro | nero | sort

6/200 63903 10/200 63906





Halsband TARA

Collar | Collier | Collar | Collare | Halsbånd

Rindsleder | Cow leather | Cuir de bœuf | Cuero de vacuno | Cuoio di bovina | Okselæder

cognac/dunkelbraun | cognac/dark brown | cognac/marron foncé | coñac/marrón oscuro | cognac/marrone scuro | cognac/mørkebrun

50 65677 55 65678

60 65679 65 65680

70 69286 75 69288

dunkelbraun/cognac | dark brown/cognac | marron foncé/cognac | marrón oscuro/coñac | marrone scuro/cognac | mørkebrun/cognac

50 65687 55 65688

60 65689 65 65690

70 69287 75 69289

№	⇒	↔	↔
50	S-M	35 – 42 cm	3,5 cm
55	M	37 – 47 cm	4,0 cm
60	M-L	41 – 51 cm	4,0 cm
65	L	47 – 57 cm	4,0 cm
70	L-XL	52 – 62 cm	4,0 cm
75	XL	57 – 67 cm	4,0 cm



Verstellbare Führleine TARA

Training leash | Laisse réglable | Correa ajustable | Guinzaglio da passeggio regolabile | Justerbar line

Rindsleder, 3-fache Verstellmöglichkeit | Cow leather, 3-fold adjustable | Cuir de bœuf, 3 possibilités de réglage | Cuero de vacuno, 3 posibilidades de ajuste | Cuoio di bovina, 3 possibilità di regolazione | Okselæder, 3-trins indstilling

cognac/dunkelbraun | cognac/dark brown | cognac/marron foncé | coñac/marrón oscuro | cognac/marrone scuro | cognac/mørkebrun

15/200 65681 20/200 65682

dunkelbraun/cognac | dark brown/cognac | marron foncé/cognac | marrón oscuro/coñac | marrone scuro/cognac | mørkebrun/cognac

15/200 65691 20/200 65692



Robustes Juchtenleder

Durable Russia leather





Alu-Strong

MADE IN GERMANY

	⇒	↔	↔
M	30 – 45 cm	1,5 cm	
L	40 – 55 cm	2,5 cm	
XL	45 – 65 cm	2,5 cm	

Halsung CANNES ALU-STRONG

Collar | Collier | Collar | Collare | Halsbånd

Rindsleder, Nappa, besonders weich, Steckverschluss aus Aluminium, Metall-Schieber | *Cow leather, Nappa, extra soft, buckle made of aluminum, metal slide* | Cuir de bœuf, Nappa, extra souple, fermeture à clips pratique d'aluminium, coulisseau en métal | *Cuero de vacuno, Napa, extrasuave, cierre a presión de aluminio, pasador metálico* | Cuoio di bovina, Nappa, extra morbida, chiusura a scatto in alluminio, fibbia di metallo | *Okselæder, Nappa, ekstra blødt, kliklås af aluminium, metalspændet*

orange | orange | orange | naranja | arancione | orange

M 68543  L 68544 
 XL 68545 

Halsband CANNES

Collar | Collier | Collar | Collare | Halsbånd

Rindsleder, Nappa, besonders weich, mit Schlüsselanhänger »Quaste« | *Cow leather, Nappa, extra soft, with keyholder »Tassel«* | Cuir de bœuf, Nappa, extra souple, avec porte-clefs »Pompon« | *Cuero de vacuno, Napa, extrasuave, con llavero »Borla«* | Cuoio di bovina, Nappa, extra morbida, con portachiavi »Nappina« | *Okselæder, Nappa, ekstra blødt, med nøglering »Kvast«*

orange | orange | orange | naranja | arancione | orange

35 63300  40 63301 
 45 63302  50 63303 
 55 61883  60 61884 
 65 61885  70 61886 



Verstellbare Führleine CANNES

Training leash | Laisse réglable | Correa ajustable | Guinzaglio da passeggio regolabile | Justerbar line

Rindsleder, Nappa, besonders weich, 3-fache Verstellmöglichkeit | *Cow leather, Nappa, extra soft, 3-fold adjustable* | Cuir de bœuf, Nappa, extra souple, 3 possibilités de réglage | *Cuero de vacuno, Napa, extrasuave, 3 posibilidades de ajuste* | Cuoio di bovina, Nappa, extra morbida, 3 possibilità di regolazione | *Okselæder, Nappa, ekstra blødt, 3-trins indstilling*

orange | orange | orange | naranja | arancione | orange

15/200 63320  20/200 61891 



MADE IN GERMANY

■	⇒	↔	↔
35	XS	19 – 27 cm	1,8 cm
40	XS-S	24 – 32 cm	1,8 cm
45	S	29 – 37 cm	2,8 cm
50	S-M	34 – 42 cm	2,8 cm
55	M	39 – 47 cm	3,5 cm
60	M-L	44 – 52 cm	3,5 cm
65	L	49 – 57 cm	3,5 cm
70	L-XL	54 – 62 cm	3,5 cm



MADE IN GERMANY



MADE
IN
GERMANY



**3D Soft
Comfort
Material**

⇒	↔*	↔.
XXS-XS	30 – 34 cm	32 – 36 cm
XS	33 – 37 cm	36 – 39 cm
XS-S	37 – 40 cm	40 – 43 cm
S	43 – 48 cm	45 – 50 cm

Geschirr HILO

Harness | Harnais | Arnés | Pettorina | Sele

Rindsleder, Nappa/Mesh-Material, eng anliegend, gute Passform | Cow leather, Nappa/Mesh material, sits securely, snug fit | Cuir de bœuf, Nappa/Matière mesh, moulant, bon ajustement | Cuero de vacuno, Nappa/Material de rejilla, ajustado, sujeción perfecta | Cuoio di bovina, Nappa/Materiale mesh, aderente, buona vestibilità | Okselader, Nappa/Mesh materiale, tetsiddende, god pasform

orange | orange | orange | naranja | arancione | orange

XXS-XS 68420 XS 68421

XS-S 68422 S 68423

schwarz | black | noir | negro | nero | sort

XXS-XS 68428 XS 68429

XS-S 68430 S 68431





l	↗	↔	∅
35	XS-S	28 – 32 cm	8 mm
40	S	33 – 37 cm	8 mm
45	S-M	38 – 42 cm	8 mm
50	M	41 – 46 cm	10 mm



↗	↔	∅
M	max. 45 cm	10 mm
M-L	max. 50 cm	10 mm
L	max. 55 cm	10 mm
L-XL	max. 60 cm	10 mm

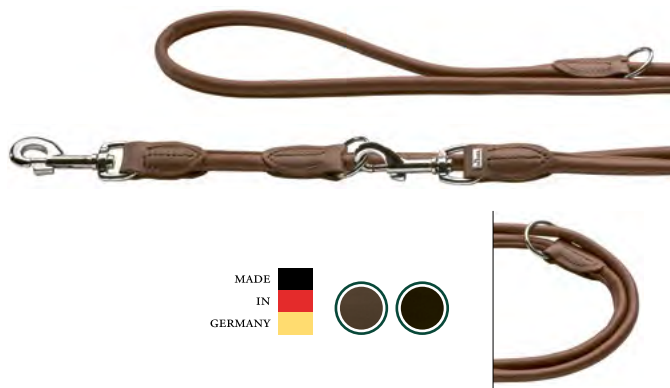

Halsband ROUND & SOFT

Collar | Collier | Collar | Collare | Halsbånd

Rindsleder, Nappa, besonders weich, robuste und reißfeste Nyloneinlage | *Cow leather, Nappa, extra soft, strong and resistant nylon rope inside* | Cuir de bœuf, Nappa, extra souple, garniture en nylon robuste et anti-déchirure | *Cuero de vacuno, Napa, extrasuave, almohadilla de nylon fuerte y resistente* | Cuoio di bovina, Nappa, extra morbida, rinforzo in nylon robusto e antistrappo | *Okselæder, Nappa, ekstra blødt, robust og rivefast nylon-indlæg*

braun | brown | marron | marrón | marrone | brun

35 41201 40 41202

45 41203 50 41204

schwarz | black | noir | negro | nero | sort

35 41207 40 41208

45 41209 50 41210

Dressurhalsung ROUND & SOFT

Training collar | Collier de dressage | Collar de adiestramiento | Collare da addestramento | Dressurhalsbånd

Rindsleder, Nappa, besonders weich, robuste und reißfeste Nyloneinlage, durch Stoppring stufenlos verstellbar | *Cow leather, Nappa, extra soft, strong and resistant nylon rope inside, with stop-ring individually adjustable* | Cuir de bœuf, Nappa, extra souple, garniture en nylon robuste et anti-déchirure, réglable en continu avec anneau d'arrêt | *Cuero de vacuno, Napa, extrasuave, almohadilla de nylon fuerte y resistente, regulable mediante anilla de bloqueo* | Cuoio di bovina, Nappa, extra morbida, rinforzo in nylon robusto e antistrappo, regolabile in continuo tramite anello di arresto | *Okselæder, Nappa, ekstra blødt, robust og rivefast nylon-indlæg, trinløs indstilling via stopring*

braun | brown | marron | marrón | marrone | brun

M 40259 M-L 40261

L 40263 L-XL 40265

schwarz | black | noir | negro | nero | sort

M 40258 M-L 40260

L 40262 L-XL 40264

Verstellbare Führleine

ROUND & SOFT

Training leash | Laisse réglable | Correa ajustable | Guinzaglio da passeggio regolabile | Justerbar line

Rindsleder, Nappa, besonders weich, robuste und reißfeste Nyloneinlage, 3-fache Verstellmöglichkeit | *Cow leather, Nappa, extra soft, strong and resistant nylon rope inside, 3-fold adjustable* | Cuir de bœuf, Nappa, extra souple, garniture en nylon robuste et anti-déchirure, 3 possibilités de réglage | *Cuero de vacuno, Napa, extrasuave, almohadilla de nylon fuerte y resistente, 3 posibilidades de ajuste* | Cuoio di bovina, Nappa, extra morbida, rinforzo in nylon robusto e antistrappo, 3 possibilità di regolazione | *Okselæder, Nappa, ekstra blødt, robust og rivefast nylon-indlæg, 3-trins indstilling*

braun | brown | marron | marrón | marrone | brun

8/200 40540 10/200 40287

schwarz | black | noir | negro | nero | sort

8/200 40539 10/200 40286



MADE
IN
GERMANY



XS

Size	Label	Length	Width
24	XXS-XS	17 – 21 cm	1,6 cm
27	XXS-XS	20 – 24 cm	1,6 cm
30	XS	23 – 27 cm	1,6 cm
32	XS	24 – 28 cm	2,6 cm
37	XS-S	30 – 34 cm	2,6 cm
42	S	35 – 39 cm	2,6 cm

Halsband DIAMOND PETIT

Collar | Collier | Collar | Collare | Halsbånd

Rindsleder, Nappa, besonders weich, für Kleinhunde | *Cow leather, Nappa, extra soft, for small dogs* | Cuir de bœuf, Nappa, extra souple, pour petits chiens | *Cuero de vacuno, Napa, extrasuave, para perros pequeños* | Cuoio di bovina, Nappa, extra morbida, per cani de piccola taglia | *Okselæder, Nappa, ekstra blødt, for små hunde*

rot/schwarz | red/black | rouge/noir | rojo/negro | rosso/nero | rød/sort

24 47717 27 47718

30 47719 32 63637

37 63638 42 63639

pink/schwarz | pink/black | rose/noir | rosa/negro | rosa carico/nero | pink/sort

24 47735 27 47736

30 47737 32 63634

37 63635 42 63636

schwarz | black | noir | negro | nero | sort

24 47726 27 47727

30 47728 32 63643

37 63644 42 63645



MADE
IN
GERMANY



XS

Führleine NAPPA PETIT

Leash | Laisse | Correa | Guinzaglio da passeggio | Line

Rindsleder, Nappa, besonders weich, mit besonders kleinem und leichtem Karabiner, für Kleinhunde | *Cow leather, Nappa, extra soft, with really small and light snap hook, for small dogs* | Cuir de bœuf, Nappa, extra souple, avec un mousqueton particulièrement petit et léger, pour petits chiens | *Cuero de vacuno, Napa, extrasuave, con mosquetón especialmente pequeño y ligero, para perros pequeños* | Cuoio di bovina, Nappa, extra morbida, con moschettone molto piccolo e leggero, per cani de piccola taglia | *Okselæder, Nappa, ekstra blødt, med meget lille og let karabinhage, for små hunde*

rot | red | rouge | rojo | rosso | rød

10/140 46431

pink | pink | rose | rosa | rosa carico | pink

10/140 46430

schwarz | black | noir | negro | nero | sort

10/140 46434





MADE
IN
GERMANY



➊	➋	➌	➍
32	XS	24 – 28 cm	2,6 cm
37	XS-S	30 – 34 cm	2,6 cm
42	S-M	35 – 40 cm	2,6 cm
47	S-M	38 – 44 cm	3,0 cm
50	S-M	35 – 43 cm	3,9 cm
55	M	41 – 49 cm	3,9 cm
60	M-L	47 – 54 cm	3,9 cm
65	L	51 – 58 cm	3,9 cm

Halsband ARIZONA UP

Collar | Collier | Collar | Collare | Halsbånd

Rindsleder | Cow leather | Cuir de boeuf | Cuero de vacuno | Cuoio di bovina | Okseleder

braun | brown | marron | marrón | marrone | brun

32	69478		37	69479	
42	69480		47	69481	
50	69482		55	69483	
60	69484		65	69485	
schwarz black noir negro nero sort					
32	69486		37	69487	
42	69488		47	69489	
50	69490		55	69491	
60	69492				



MADE
IN
GERMANY



Verstellbare Führleine ARIZONA UP

Training leash | Laisse réglable | Correa ajustable | Guinzaglio da passeggio regolabile | Justerbar line

Rindsleder, 3-fache Verstellmöglichkeit | Cow leather, 3-fold adjustable | Cuir de boeuf, 3 possibilités de réglage | Cuero de vacuno, 3 posibilidades de ajuste | Cuoio di bovina, 3 possibilità di regolazione | Okseleder, 3-trins indstilling

braun | brown | marron | marrón | marrone | brun

13/200	69493		18/200	69494	
schwarz black noir negro nero sort					
13/200	69495		18/200	69496	





MADE
IN
GERMANY



■i	⇒	↔	↔
50	S-M	35 – 43 cm	3,9 cm
55	M	41 – 49 cm	3,9 cm
60	M-L	47 – 54 cm	3,9 cm

Halsband SIOUX

Collar | Collier | Collar | Collare | Halsbånd

Rindsleder | Cow leather | Cuir de bœuf | Cuero de vacuno | Cuoio di bovina | Okseleder

schwarz | black | noir | negro | nero | sort

50 41609 55 41610

60 41611



MADE
IN
GERMANY



■i	⇒	↔	↔
45	S	29 – 37 cm	3,5 cm
50	S-M	34 – 42 cm	3,5 cm
55	M	35 – 45 cm	4,0 cm
60	M-L	40 – 50 cm	4,0 cm
65	L	45 – 55 cm	4,0 cm
70	L-XL	50 – 60 cm	4,0 cm
75	XL	55 – 65 cm	4,0 cm

Halsband MADONA

Collar | Collier | Collar | Collare | Halsbånd

Rindsleder, Nappa | Cow leather, Nappa | Cuir de boeuf, Nappa | Cuero de vacuno, Napa | Cuoio di bovina, Nappa | Okseleder, Nappa

schwarz | black | noir | negro | nero | sort

45 69327 50 69328

55 69329 60 69330

65 69331 70 69332

75 69333



MADE
IN
GERMANY



■i	⇒	↔	↔
25	XXS-XS	16 – 20 cm	2,0 cm
30	XS	19 – 25 cm	2,0 cm
35	XS-S	24 – 30 cm	2,0 cm
40	XS-S	26 – 32 cm	2,6 cm
45	S	31 – 37 cm	2,6 cm

Halsband MODICA

Collar | Collier | Collar | Collare | Halsbånd

Rindsleder, Nappa | Cow leather, Nappa | Cuir de boeuf, Nappa | Cuero de vacuno, Napa | Cuoio di bovina, Nappa | Okseleder, Nappa

schwarz | black | noir | negro | nero | sort

25 69337 30 69338

35 69339 40 69340

45 69341







■i	⇒	⇔	↔
35	XS-S	21 – 27 cm	2,6 cm
40	XS-S	26 – 32 cm	2,6 cm
45	S	31 – 37 cm	2,6 cm
50	S-M	34 – 42 cm	3,5 cm
55	M	39 – 47 cm	3,5 cm
60	M-L	44 – 52 cm	3,5 cm

Halsband TIJUANA

Collar | Collier | Collar | Collare | Halsbånd

Rindsleder, Nappa | Cow leather, Nappa | Cuir de boeuf, Nappa | Cuero de vacuno, Napa | Cuoio di bovina, Nappa | Okselæder, Nappa

schwarz | black | noir | negro | nero | sort

35	69334		40	69335	
45	69336		50	69843	
55	69844		60	69845	



■i	⇒	⇔	↔
55	M	41 – 49 cm	3,9 cm
60	M-L	47 – 54 cm	3,9 cm
65	L	51 – 58 cm	3,9 cm

Halsband RAMBO

Collar | Collier | Collar | Collare | Halsbånd

Rindsleder | Cow leather | Cuir de boeuf | Cuero de vacuno | Cuoio di bovina | Okselæder

schwarz | black | noir | negro | nero | sort

55	20281		60	20282	
65	20283				

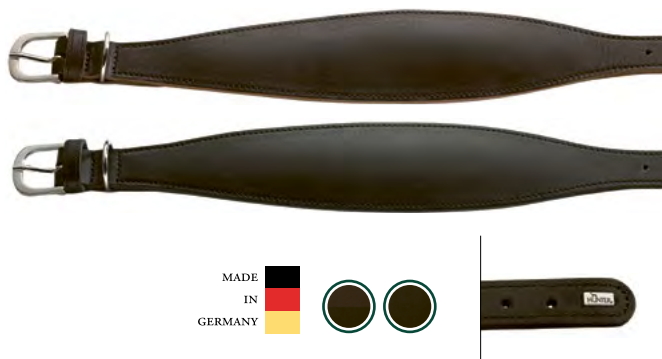

■i	⇒	⇔	↔
32	XS	25 – 28 cm	4,2 cm
37	XS-S	29 – 33 cm	5,0 cm
42	S	33 – 39 cm	6,0 cm
47	S-M	37 – 43 cm	6,5 cm
52	M	41 – 48 cm	6,5 cm

Windhundhalsband SUPER SOFT

Greyhound collar | Collier de lévrier | Collar para galgo | Collare levriero | Vindhund-halsbånd

Rindsleder | Cow leather | Cuir de boeuf | Cuero de vacuno | Cuoio di bovina | Okselæder

dunkelbraun | dark brown | marron foncé | marrón oscuro | marrone scuro | mørkebrun

32	62505		37	62506	
42	62507		47	62508	
52	62701				
schwarz black noir negro nero sort					
32	62501		37	62502	
42	62503		47	62504	
52	62700				



MADE
IN
GERMANY



Size	Label	Length	Width
55	M	38 – 47 cm	4,8 cm
60	M-L	43 – 52 cm	4,8 cm
65	L	48 – 57 cm	4,8 cm
70	L-XL	53 – 62 cm	4,8 cm

Trainingshalsband mit Griff LARVIK

Training collar with handle | Collier d'entraînement avec poignée
| Collar de adiestramiento con asa | Collare da addestramento con impugnatura | Treningshalsbånd med håndtag

Rindsleder, mit Griff | cow leather, with handle | Cuir de bœuf, avec poignée | Cuero de vacuno, con asa | Cuoio di bovina, con impugnatura
| Okselæder, med greb

schwarz | black | noir | negro | nero | sort

55	67012		60	67013	
65	67014		70	67015	



Für Super-Komfort
For super comfort

Damit lässt sich arbeiten!

You can work with it!

Robustes Rindsleder bildet die Basis dieses Must-Haves. Der besonders fest vernähte Griff aus hochwertigem Leder macht es möglich, den Hund in Sekundenschnelle sicher zu halten und zu kontrollieren. In allen Situationen, in denen der eigene Hund unterstützt oder korrigiert werden muss (zum Beispiel im Straßenverkehr oder im Schutzdienst) leistet LARVIK wertvolle Dienste. Entwickelt wurde das komplett genähte Trainingshalsband vor allem für große und starke Hunde. Dank der besonders guten Druckverteilung über die breite Auflagefläche und der Unterlegung mit gebügtem Nappaleder sitzt LARVIK so angenehm am Hals, dass der Hund sich genau auf die Aufgaben und Kommandos konzentrieren kann, die er ausführen soll. An dem O-Ring, der sich frei beweglich am »Handgriff« befindet, kann eine beliebige Leine eingehakt werden.

Strong cow leather forms the basis of this must-have, with the especially tightly sewn handle made from high-quality leather making it possible to safely hold and control the dog in a matter of seconds. LARVIK is there to perform in every kind of situation in which your dog needs to be supported or corrected (for example in traffic or in protection services). The wholly-sewn training collar was developed especially for large and strong dogs. Thanks to especially good pressure distribution over the wide contact surface and the curved nappa leather lining, LARVIK is such a comfortable fit on your dog's neck that they can concentrate solely on the tasks and commands they are supposed to carry out. Any leash can be hooked onto the O-ring, which is attached to the handle and is freely movable.



BESTE KONTROLLE
best control





Halsband LARVIK

Collar | Collier | Collar | Collare | Halsbånd

Rindsleder | Cow leather | Cuir de bœuf | Cuero de vacuno | Cuoio di bovina | Okselæder

cognac/schwarz | cognac/black | cognac/noir | coñac/negro | cognac/nero | cognac/sort

50 66163 55 66164

60 66165

dunkelbraun/schwarz | dark brown/black | marron foncé/noir | marrón oscuro/negro | marrone scuro/nero | mørkebrun/sort

50 66169 55 66170

60 66171

schwarz | black | noir | negro | nero | sort

50 66138 55 66139

60 66140

Size	Age	Length	Width
50	S-M	35 – 42 cm	2,8 cm
55	M	36 – 46 cm	3,5 cm
60	M-L	42 – 52 cm	3,5 cm



Führschlaufe

Traffic leash | Poignée | Lazo de paseo | Maniglia per guinzaglio da passeggio | Håndtag

Rindsleder | Cow leather | Cuir de bœuf | Cuero de vacuno | Cuoio di bovina | Okselæder

schwarz | black | noir | negro | nero | sort

18/35 66053



Kettenführleine

Chain leash | Laisse en chaîne | Correa de cadena | Guinzaglio di catena | Kædeline

Rindsleder | Cow leather | Cuir de bœuf | Cuero de vacuno | Cuoio di bovina | Okselæder

schwarz | black | noir | negro | nero | sort

13/110 66050 16/110 66051

18/110 66052



Führleine

Leash | Laisse | Correa | Guinzaglio da passeggio | Line | Leiband

Rindsleder | *Cow leather* | Cuir de bœuf | *Cuero de vacuno* | Cuoio di bovina | *Okselæder* | In zekere zin vertegenwoordigt deze riem de volgende generatie zacht en vol rundleder. Dankzij het bijzonder hoge vetgehalte en de natuurlijke looiing is het ook bestand tegen hoge trekkrachten en dus bijzonder geschikt voor hondensport. Het leer is namelijk niet alleen extreem robuust. De hondერიem ligt ook extreem soepel in de hand. Let op: Ons leer wordt zo milieuvriendelijk mogelijk geproduceerd. Bij geverfd leer kan aanvankelijk een lichte verkleuring optreden.

orange | orange | orange | naranja | arancione | orange

13/110 205090 16/100 205091

20/100 205092

rot | red | rouge | rojo | rosso | rød

13/110 68345 16/100 68346

20/100 68347

dunkelblau | dark blue | bleu foncé | azul oscuro | blu scuro | mørkeblå

13/110 68342 16/100 68343

20/100 68344

oliv | olive | olive | oliva | oliva | olivenfarvet

13/110 67299 16/100 67300

20/100 67301

cognac | cognac | cognac | coñac | cognac | cognac

13/110 66060 16/100 66061

20/100 66062

dunkelbraun | dark brown | marron foncé | marrón oscuro | marrone scuro | mørkebrun

13/110 66075 16/100 66076

20/100 66077

steingrau | stone grey | gris pierre | gris piedra | grigio pietra | stengrå

13/110 205077 16/100 205078

20/100 205079

schwarz | black | noir | negro | nero | sort

13/110 66041 16/100 66042

20/100 66043

Verstellbare Führleine

Training leash | Laisse réglable | Correa ajustable | Guinzaglio da passeggio regolabile | Justerbar line

Rindsleder, 3-fache Verstellmöglichkeit | *Cow leather, 3-fold adjustable*
 | Cuir de bœuf, 3 possibilités de réglage | *Cuero de vacuno, 3 posibilidades de ajuste*
 | Cuoio di bovina, 3 possibilità di regolazione | *Okselæder, 3-trins indstilling*



**NEW
colours**

MADE
IN
GERMANY

natur | tan | nature | natural | naturale | natur

13/200 66032 16/200 66033

20/200 66034

orange | orange | orange | naranja | arancione | orange

13/200 205094 15/200 205095

20/200 205096

rot | red | rouge | rojo | rosso | rød

13/200 68351 16/200 68352

20/200 68353

dunkelblau | dark blue | bleu foncé | azul oscuro | blu scuro | mørkeblå

13/200 68348 16/200 68349

20/200 68350

oliv | olive | olive | oliva | oliva | olivenfarvet

13/200 67302 16/200 67303

20/200 67304

cognac | cognac | cognac | coñac | cognac | cognac

13/200 66063 16/200 66064

20/200 66065

dunkelbraun | dark brown | marron foncé | marrón oscuro | marrone scuro
 | mørkebrun

13/200 66078 16/200 66079

20/200 66080

steingrau | stone grey | gris pierre | gris piedra | grigio pietra | stengrå

13/200 205081 16/200 205082

20/200 205083

schwarz | black | noir | negro | nero | sort

13/200 66044 16/200 66045

20/200 66046

Verstellbare Führleine COMFORT

Training leash | Laisse réglable | Correa ajustable | Guinzaglio da passeggio regolabile | Justerbar line

Rindsleder, 3-fache Verstellmöglichkeit | *Cow leather, 3-fold adjustable*
 | Cuir de bœuf, 3 possibilités de réglage | *Cuero de vacuno, 3 posibilidades de ajuste*
 | Cuoio di bovina, 3 possibilità di regolazione | *Okselæder, 3-trins indstilling*

cognac/schwarz | cognac/black | cognac/noir | coñac/negro | cognac/nero |
 cognac/sort

15/200 66067 20/200 66068

dunkelbraun/schwarz | dark brown/black | marron foncé/noir | marrón oscuro/
 negro | marrone scuro/nero | mørkebrun/sort

15/200 66082 20/200 66083

schwarz | black | noir | negro | nero | sort

15/200 66048 20/200 66049



MADE
IN
GERMANY



Doppellagig verarbeitet
Double-layer processing



Solid Education

Mit der Premium-Lederqualität sind die Artikel unserer Klassiker-Serie SOLID EDUCATION nicht nur beim Hundesport und in der Ausbildung gern gesehen, bestechen sie doch durch ihre aufwendigen, in Handarbeit geflochtenen Elemente und das angenehm weiche Leder. Natürlich »Made in Germany«.

With their premium leather quality, the items in our classic series SOLID EDUCATION are not only popular in dog sports and training training, as they are characterised by their elaborate hand-braided braided elements and the pleasantly soft leather. Of course »Made in Germany«.



MADE
IN
GERMANY



Dressurhalsung SOLID EDUCATION

Training collar | Collier de dressage | Collar de adiestramiento |
Collare da addestramento | Dressurhalsbånd

Rindsleder, abgerundete Kanten, Stoppring eingeflochten | Cow
leather, rounded edges, stop-ring plaited into the leather | Cuir de bœuf,
lisières courbées, anneau d'arrêt à émerillon entrecroisé | Cuero de
vacuno, puntillas redondas, anilla de bloqueo trenzado en el cuero | Cuoio
di bovina, bordi arrotondati, anello di arresto intrecciati | Okseleder,
afrundede kanter, med stopring (indflettet)

oliv | olive | olive | oliva | oliva | olivenfarvet

S-M 67305 M 67306

M-L 67307 L 67308

L-XL 67309

cognac | cognac | cognac | coñac | cognac | cognac

S-M 66101 M 66102

M-L 66103 L 66104

L-XL 66105

dunkelbraun | dark brown | marron foncé | marrón oscuro | marrone scuro
| mørkebrun

S-M 66116 M 66117

M-L 66118 L 66119

L-XL 66120

schwarz | black | noir | negro | nero | sort

S-M 66084 M 66085

M-L 66086 L 66087

L-XL 66088



↕	↔	↔
S-M	35 – 40 cm	1,8 cm
M	40 – 45 cm	1,8 cm
M-L	45 – 50 cm	1,8 cm
L	50 – 55 cm	1,8 cm
L-XL	55 – 60 cm	1,8 cm



MADE
IN
GERMANY



Size	Label	Length	Width
45	S	33 – 38 cm	2,5 cm
50	S-M	35 – 44 cm	2,5 cm
55	M	41 – 49 cm	2,5 cm

Halsband SOLID EDUCATION SPECIAL

Collar | Collier | Collar | Collare | Halsbånd

Rindsleder, handgeflochten, aus einem durchgehenden Lederstück gefertigt | Cow leather, hand-braided, made from a single piece of leather | Cuir de bœuf, cousu à la main, fait d'une seule pièce de cuir | Cuero de vacuno, trenzada a mano a partir de una única pieza de cuero | Cuoio di bovina, intrecciato a mano, realizzato da un pezzo unico di pelle | Okselæder, håndvævet, lavet af et kontinuerligt stykke leder

oliv | olive | olive | oliva | oliva | olivenfarvet

45 67571 50 67572

55 67573

cognac | cognac | cognac | coñac | cognac | cognac

45 67288 50 67289

55 67290

dunkelbraun | dark brown | marron foncé | marrón oscuro | marrone scuro | mørkebrun

45 67283 50 67284

55 67285

schwarz | black | noir | negro | nero | sort

45 67278 50 67279

55 67280





	MADE IN GERMANY	50	S-M	35 – 42 cm	4 cm
		55	M	40 – 47 cm	4 cm
		60	M-L	45 – 52 cm	4 cm

Halsband SOLID EDUCATION EXCLUSIVE

Collar | Collier | Collar | Collare | Halsbånd

Rindsleder, handgeflochten | Cow leather, hand-braided | Cuir de bœuf, cousu à la main | Cuero de vacuno, trenzada a mano | Cuoio di bovina, intrecciato a mano | Okseleder, håndvævet

dunkelbraun/schwarz | dark brown/black | marron foncé/noir | marrón oscuro/negro | marrone scuro/nero | mørkebrun/sort

50	67235		55	67236	
60	67237				



50	S-M	37 – 43 cm	3,5 cm
55	M	42 – 48 cm	3,5 cm
60	M-L	46 – 52 cm	3,5 cm
65	L	50 – 56 cm	3,5 cm

Halsband EL PASO

Collar | Collier | Collar | Collare | Halsbånd

Rindsleder, handgeflochten | Cow leather, hand-braided | Cuir de bœuf, cousu à la main | Cuero de vacuno, trenzada a mano | Cuoio di bovina, intrecciato a mano | Okseleder, håndvævet

cognac/schwarz | cognac/black | cognac/noir | coñac/negro | cognac/nero | cognac/sort

50	68555		55	68556	
60	68557		65	68558	

dunkelbraun/schwarz | dark brown/black | marron foncé/noir | marrón oscuro/negro | marrone scuro/nero | mørkebrun/sort

50	68559		55	68560	
60	68561		65	68562	





Führleine SOLID EDUCATION

Leash | Laisse | Correa | Guinzaglio da passeggio | Line

Rindsleder, handgeflochten, abgerundete Kanten, Bolzenhaken eingeflochten | Cow leather, hand-braided, rounded edges, snap-hook plaited into the leather | Cuir de bœuf, cousu à la main, lisières courbées, mousqueton à émerillon entrecroisé | Cuero de vacuno, trenzada a mano, puntillas redondas, mosquetón trenzado en el cuero | Cuoio di bovina, intrecciato a mano, bordi arrotondati, ganci intrecciati | Okseleder, håndvævet, afrundede kanter, med karabinhage (indflettet)

rot | red | rouge | rojo | rosso | rød

11/110 68398 11/150 68399

11/200 68400 16/100 68401

16/150 68402 16/200 68403

dunkelblau | dark blue | bleu foncé | azul oscuro | blu scuro | mørkeblå

11/110 68392 11/150 68393

11/200 68394 16/100 68395

16/150 68396 16/200 68397

oliv | olive | olive | oliva | oliva | olivenfarvet

11/110 67310 11/150 67312

11/200 67314 16/100 67311

16/150 67313 16/200 67315

cognac | cognac | cognac | coñac | cognac | cognac

11/110 66106 11/150 66108

11/200 66110 16/100 66107

16/150 66109 16/200 66111

dunkelbraun | dark brown | marron foncé | marrón oscuro | marrone scuro | mørkebrun

11/110 66121 11/150 66123

11/200 66125 16/100 66122

16/150 66124 16/200 66126

schwarz | black | noir | negro | nero | sort

11/110 66089 11/150 66091

11/200 66093 16/100 66090

16/150 66092 16/200 66094



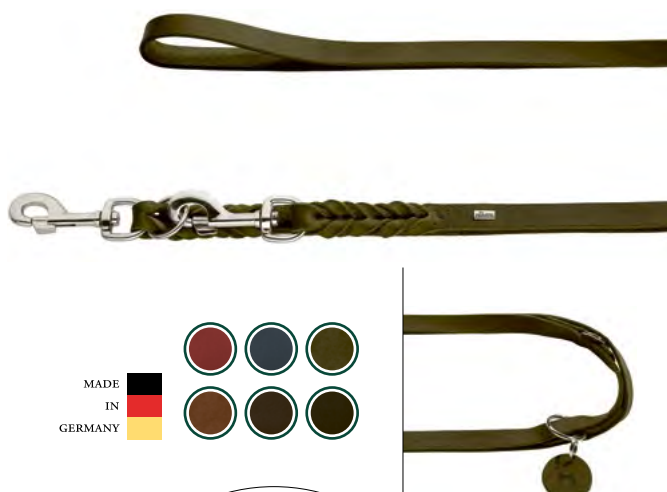

Verstellbare Führleine SOLID EDUCATION

Training leash | Laisse réglable | Correa ajustable | Guinzaglio da passeggio regolabile | Justerbar line

Rindsleder, handgeflochten, abgerundete Kanten, Bolzenhaken eingeflochten, 3-fache Verstellmöglichkeit | *Cow leather, hand-braided, rounded edges, snap-hook plaited into the leather, 3-fold adjustable* | Cuir de bœuf, cousu à la main, lisières courbées, mousqueton à émerillon entrecroisé, 3 possibilités de réglage | *Cuero de vacuno, trenzada a mano, puntillas redondas, mosquetón trenzado en el cuero, 3 posibilidades de ajuste* | Cuoio di bovina, intrecciato a mano, bordi arrotondati, ganci intrecciati, 3 possibilità di regolazione | *Okselader, håndvævet, afrundede kanter, med karabinhage (indflettet), 3-trins indstilling*

rot | red | rouge | rojo | rosso | rød

13/200 68408  18/200 68410 

dunkelblau | dark blue | bleu foncé | azul oscuro | blu scuro | mørkeblå

13/200 68404  18/200 68406 

oliv | olive | olive | oliva | oliva | olivenfarvet

13/200 67316  13/250 67318 

18/200 67317  18/250 67319 

cognac | cognac | cognac | coñac | cognac | cognac

13/200 66112  13/250 66114 

18/200 66113  18/250 66115 

dunkelbraun | dark brown | marron foncé | marrón oscuro | marrone scuro | mørkebrun

13/200 66127  13/250 66129 

18/200 66128  18/250 66130 

schwarz | black | noir | negro | nero | sort

13/200 66095  13/250 66097 

18/200 66096  18/250 66098 





Retriever-Leine SOLID EDUCATION

Retriever leash | Laisse pour retriever | Correa para retriever | Guinzaglio retriever | Retrieverline

Rindsleder, durch Spezialschieber stufenlos verstellbar | *Cow leather, individually adjustable by special slide* | Cuir de bœuf, réglable en continu à l'aide d'un curseur spécial | *Cuero de vacuno, regulable en continuo mediante pasador especial* | Cuoio di bovina, regolazione scorrevole tramite regolatore speciale | *Okselæder, ed specialskeydelukning på trinløs indstilling*

cognac | cognac | cognac | coñac | cognac | cognac

18/170 69080 



Kurzführer SOLID EDUCATION

Short leash | Laisse courte | Guía breve | Guinzaglio corto | Kort line

Rindsleder, abgerundete Kanten, Bolzenhaken eingeflochten | *Cow leather, rounded edges, snap-hook plaited into the leather* | Cuir de bœuf, bords arrondis, mousqueton cousu | *Cuero de vacuno, con bordes redondeados y mosquetón integrado en el cuero* | Cuoio di bovina, bordi arrotondati, dotato di moschettone | *Okselæder, afrundede kanter, boltede kroge indflettet*

schwarz | black | noir | negro | nero | sort

18/40 67229 



Suchleine SOLID EDUCATION

Tracking leash | Laisse de promenade | Correa de rastreo | Guinzaglio da ricerca | Søgeline

Rindsleder, abgerundete Kanten, Bolzenhaken eingeflochten, besonders geeignet zum Einsatz bei der Ausbildung und im Hundesport | *Cow leather, rounded edges, woven bolt hooks, particularly suitable for training and in dog sports* | Cuir de bœuf, bords arrondis, mousquetons tressés, convient particulièrement bien pour le dressage et les sports canins | *Cuero de vacuno, bordi arrotondati, ganci con bulloni, particolarmente adatto per l'uso in addestramento e nello sport per cani* | Cuoio di bovina, cantos redondeados, gancho intercalado, especialmente adecuado para enseñar y hacer deporte con el perro | *Okselæder, afrundede kanter, indvævet karabinhage, særlig godt egnet til uddannelse og i hundesport*

schwarz | black | noir | negro | nero | sort

11/500 66099  18/500 66100 

Kombileine 6in1 SOLID EDUCATION

Combi-leash 6in1 | Laisse multifonction 6en1 | Correa combinada 6en1 | Guinzaglio combinato 6in1 | Kombiline 6i1

Rindsleder, 6-fache Verwendbarkeit als Führschlaufe, Umhängeleine, Koppel, Langleine, Führleine und Kurzführer | Cow leather, can be used 6 ways as loop leash, wrap-around leash, belt, long leash, guide leash and short leash | Cuir de bœuf, 6 utilisations possibles comme poignée, laisse-bandoulière, laisse double, laisse longue, lanière et laisse courte | Cuero de vacuno, utilizzabile in 6 modalità diverse, come cinghia da passeggio, guinzaglio regolabile, guinzaglio doppio, guinzaglio lungo, guinzaglio e guinzaglio corto | Cuoio di bovina, 6 opzioni de uso como correa de lazo, correa manos libres, correa múltiple, correa larga, correa de entrenamiento y correa corta | Okseleder, 6 funktioner som føresløjfe, omhængeline, livrem, langline, føreline og kortfører

6-in-1

- ➔ Führschlaufe / Loop leash
- ➔ Umhängeleine / Wrap-around leash
- ➔ Koppel / Belt
- ➔ Langleine / Long leash
- ➔ Führleine / Guide leash
- ➔ Kurzführer / Short leash

dunkelbraun | dark brown | marron foncé | marrón oscuro | marrone scuro
| mørkebrun

18/310 66133 

MADE
IN
GERMANY 





Size	Label	Length	Width
40	S	29 – 35 cm	2,0 cm
45	S	32 – 39 cm	2,0 cm
50	S-M	37 – 44 cm	2,0 cm
55	M	42 – 49 cm	2,0 cm
60	M-L	47 – 54 cm	2,0 cm

Halsband SOLID EDUCATION DUO

Collar | Collier | Collar | Collare | Halsbånd

Rindsleder, handgeflochten | Cow leather, hand-braided | Cuir de bœuf, cousu à la main | Cuero de vacuno, trenzada a mano | Cuoio di bovina, intrecciato a mano | Okseleder, håndvevet

cognac/oliv | cognac/olive | cognac/olive | coñac/oliva | cognac/oliva | cognac/olivenfarvet

40	69070		45	69071	
50	69072		55	69073	
60	69074				

dunkelbraun/oliv | dark brown/olive | marron foncé/olive | marrón oscuro/oliva | marrone scuro/oliva | mørkebrun/olivenfarvet

40	69075		45	69076	
50	69077		55	69078	
60	69079				



Verstellbare Führleine SOLID EDUCATION DUO

Training leash | Laisse réglable | Correa ajustable | Guinzaglio da passeggio regolabile | Justerbar line

Rindsleder, abgerundete Kanten, Bolzenhaken eingeflochten, 3-fache Verstellmöglichkeit | Cow leather, rounded edges, snap-hook plaited into the leather, 3-fold adjustable | Cuir de bœuf, lisières courbées, mousqueton à émerillon entrecroisé, 3 possibilités de réglage | Cuero de vacuno, puntillas redondas, mosquetón trenzado en el cuero, 3 posibilidades de ajuste | Cuoio di bovina, bordi arrotondati, ganci intrecciati, 3 possibilità di regolazione | Okseleder, afrundede kanter, med karabinhage (indflettet), 3-trins indstilling

cognac/oliv | cognac/olive | cognac/olive | coñac/oliva | cognac/oliva | cognac/olivenfarvet

20/200	69068	
dunkelbraun/oliv dark brown/olive marron foncé/olive marrón oscuro/oliva marrone scuro/oliva mørkebrun/olivenfarvet		
20/200	69069	





№	↕	↔	↔
40	S	30 – 36 cm	2,0 cm
45	S	35 – 41 cm	2,0 cm
50	S–M	40 – 46 cm	2,0 cm
55	M	45 – 51 cm	2,0 cm
60	M–L	50 – 56 cm	2,0 cm

Halsband SOLID EDUCATION CORD

Collar | Collier | Collar | Collare | Halsbånd

Rindsleder, handgeflochten | *Cow leather, hand-braided* | Cuir de boeuf, cousu à la main | *Cuero de vacuno, trenzada a mano* | Cuoio di bovina, intrecciato a mano | *Okselæder, håndvævet*

dunkelbraun/orange | dark brown/orange | marron foncé/orange | marrón oscuro/naranja | marrone scuro/arancione | mørkebrun/arancione

40	69315		45	69316	
50	69317		55	69318	
60	69319				

dunkelbraun/türkis | dark brown/turquoise | marron foncé/turquoise | marrón oscuro/turquesa | marrone scuro/turchese | mørkebrun/turkis

40	69320		45	69321	
50	69322		55	69323	
60	69324				



Verstellbare Führleine SOLID EDUCATION CORD

Training leash | *Laisse réglable* | *Correa ajustable* | *Guinzaglio da passeggio regolabile* | *Justerbar line*

Rindsleder, handgeflochten | *Cow leather, hand-braided* | Cuir de boeuf, cousu à la main | *Cuero de vacuno, trenzada a mano* | Cuoio di bovina, intrecciato a mano | *Okselæder, håndvævet*

dunkelbraun/orange | dark brown/orange | marron foncé/orange | marrón oscuro/naranja | marrone scuro/arancione | mørkebrun/arancione

20/200 69325

dunkelbraun/türkis | dark brown/turquoise | marron foncé/turquoise | marrón oscuro/turquesa | marrone scuro/turchese | mørkebrun/turkis

20/200 69326





MADE
IN
GERMANY



Size	Label	Length	Width
40	S	30 – 36 cm	2,6 cm
45	S-M	34 – 40 cm	2,6 cm
50	S-M	38 – 44 cm	3,0 cm
55	M	43 – 49 cm	3,0 cm
60	M-L	48 – 54 cm	3,0 cm
65	L	52 – 59 cm	3,0 cm

Halsband SANSIBAR SOLID

Collar | Collier | Collar | Collare | Halsbånd

Rindsleder | Cow leather | Cuir de bœuf | Cuero de vacuno | Cuoio di bovina | Okseleder

dunkelbraun | dark brown | marron foncé | marrón oscuro | marrone scuro | mørkebrun

40 66857 45 66858

50 66859 55 66860

60 66861 65 66862

schwarz | black | noir | negro | nero | sort

40 66845 45 66846

50 66847 55 66848

60 66849 65 66850



MADE
IN
GERMANY

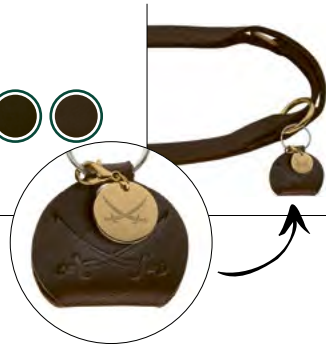

Verstellbare Führleine

SANSIBAR SOLID

Training leash | Laisse réglable | Correa ajustable | Guinzaglio da passeggio regolabile | Justerbar line

Rindsleder, 3-fache Verstellmöglichkeit | Cow leather, 3-fold adjustable | Cuir de bœuf, 3 possibilités de réglage | Cuero de vacuno, 3 posibilidades de ajuste | Cuoio di bovina, 3 possibilità di regolazione | Okseleder, 3-trins indstilling

dunkelbraun | dark brown | marron foncé | marrón oscuro | marrone scuro | mørkebrun

15/200 66863 20/200 66864

schwarz | black | noir | negro | nero | sort

15/200 66851 20/200 66852



MADE
IN
GERMANY



	↔	↔
M	30 – 45 cm	1,5 cm
L	40 – 55 cm	2,0 cm
XL	45 – 65 cm	2,5 cm

Halsung SANSIBAR

Collar | Collier | Collar | Collare | Halsbånd

Rindsleder | Cow leather | Cuir de boeuf | Cuero de vacuno | Cuoio di bovina | Okselæder

cognac | cognac | cognac | coñac | cognac | cognac

M 69578 L 69579

XL 69580

dunkelbraun | dark brown | marron foncé | marrón oscuro | marrone scuro
| mørkebrun

M 69581 L 69582

XL 69583



MADE
IN
GERMANY



Verstellbare Führleine SANSIBAR

Training leash | Laisse réglable | Correa ajustable | Guinzaglio da passeggio regolabile | Justerbar line

Rindsleder, 3-fache Verstellmöglichkeit | Cow leather, 3-fold adjustable | Cuir de boeuf, 3 possibilités de réglage | Cuero de vacuno, 3 posibilidades de ajuste | Cuoio di bovina, 3 possibilità di regolazione | Okselæder, 3-trins indstilling

cognac | cognac | cognac | coñac | cognac | cognac

15/200 69584 20/200 69585

dunkelbraun | dark brown | marron foncé | marrón oscuro | marrone scuro
| mørkebrun

15/200 69586 20/200 69587





Aalborg

Die Serie AALBORG hat sich zu einem absoluten Star in unseren Produktreihen entwickelt. Bedingt durch die Erweiterung des Sortiments und die zusätzliche Verbesserung des Leders, das nicht nur durch seine wunderbar angenehme Griffbarkeit überzeugt, sondern auch durch die satte Farbauswahl. Insbesondere unser Meistergeschirr sticht dabei durch seine aufwändige Verarbeitung und den perfekten Sitz an nahezu jedem Vierbeiner heraus. Wählen Sie AALBORG und lassen Sie sich begeistern! Made by HUNTER - »Made in Germany«.

AALBORG has become a real star among our product families. To achieve that, we have not only expanded the range and further improved the leather used, which impresses with wonderfully pleasant grip, but also introduced a broad selection of colours. Our master harness, in particular, impresses with its outstanding workmanship and a perfect fit on almost any dog. Choose AALBORG – you won't be disappointed! Made by HUNTER - »Made in Germany«.

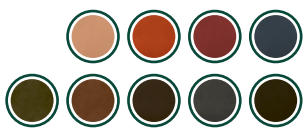

Halsband AALBORG

Collar | Collier | Collar | Collare | Halsbånd

Rindsleder | Cow leather | Cuir de bœuf | Cuero de vacuno | Cuoio di bovina | Okselæder

natur | tan | nature | natural | naturale | natur

32	66023		37	66024	
42	66025		47	66026	
52	66027		60	66028	

orange | orange | orange | naranja | arancione | orange

32	205084		37	205085	
42	205086		47	205087	
52	205088		60	205089	

rot | red | rouge | rojo | rosso | rød

32	68336		37	68337	
42	68338		47	68339	
52	68340		60	68341	

dunkelblau | dark blue | bleu foncé | azul oscuro | blu scuro | mørkeblå

32	68330		37	68331	
42	68332		47	68333	
52	68334		60	68335	

oliv | olive | olive | oliva | oliva | olivenfarvet

32	67293		37	67294	
42	67295		47	67296	
52	67297		60	67298	

cognac | cognac | cognac | coñac | cognac | cognac

32	66054		37	66055	
42	66056		47	66057	
52	66058		60	66059	

dunkelbraun | dark brown | marron foncé | marrón oscuro | marrone scuro | mørkebrun

32	66069		37	66070	
42	66071		47	66072	
52	66073		60	66074	

steingrau | stone grey | gris pierre | gris piedra | grigio pietra | stengrå

32	205071		37	205072	
42	205073		47	205074	
52	205075		60	205076	

schwarz | black | noir | negro | nero | sort

32	66035		37	66036	
42	66037		47	66038	
52	66039		60	66040	

MADE IN GERMANY		☐I	⇒	↔	↔
		32	XS	24 – 29 cm	1,2 cm
		37	XS-S	28 – 33 cm	1,4 cm
		42	S	32 – 38 cm	1,6 cm
		47	S-M	37 – 43 cm	1,8 cm
		52	M	38 – 47 cm	2,0 cm
		60	L	45 – 55 cm	2,5 cm



MADE
IN
GERMANY



cm	⇒	↔	↔
30	XXS-XS	20 – 24 cm	2,0 cm
35	XS-S	24 – 30 cm	2,0 cm
40	S	29 – 35 cm	2,0 cm
45	S	30 – 38 cm	3,5 cm
50	S-M	36 – 44 cm	3,5 cm
55	M	41 – 49 cm	3,5 cm
60	M-L	41 – 51 cm	4,5 cm
65	L	46 – 56 cm	4,5 cm
70	L-XL	51 – 61 cm	4,5 cm
75	XL	56 – 66 cm	4,5 cm
80	XL-XXL	61 – 71 cm	4,5 cm



Jetzt auch in
EXTRA-GROSS
Besonders lang & extrabreit für mehr Komfort

Now available in extra-large. Extra long and extra wide for more comfort

XXL



Halsband AALBORG SPECIAL

Collar | Collier | Collar | Collare | Halsbånd

Rindsleder | Cow leather | Cuir de bœuf | Cuero de vacuno | Cuoio di bovina | Okseleder

rot | red | rouge | rojo | rosso | rød

30	68363	35	68364
40	68365	45	68366
50	68367	55	68368
60	68369	65	68370
70	68371	75	205234
80	205235		

dunkelblau | dark blue | bleu foncé | azul oscuro | blu scuro | mørkeblå

40	68356	45	68357
50	68358	55	68359
60	68360	65	68361
70	68362		

oliv | olive | olive | oliva | oliva | olivenfarvet

30	67269	35	67270
40	67271	45	67272
50	67273	55	67274
60	67275	65	67276
70	67277	75	205232
80	205233		

cognac | cognac | cognac | coñac | cognac | cognac

30	67260	35	67261
40	67262	45	67263
50	67264	55	67265
60	67266	65	67267
70	67268	75	205228
80	205229		

dunkelbraun | dark brown | marron foncé | marrón oscuro | marrone scuro | mørkebrun

30	67251	35	67252
40	67253	45	67254
50	67255	55	67256
60	67257	65	67258
70	67259	75	205230
80	205231		

schwarz | black | noir | negro | nero | sort

30	67242	35	67243
40	67244	45	67245
50	67246	55	67247
60	67248	65	67249
70	67250	75	205236
80	205237		



Halsband AALBORG EXTRABREIT

Collar | Collier | Collar | Collare | Halsbånd

Rindsleder, besonders breit | Cow leather, extra wide | Cuir de boeuf, particulièrement large | Cuero de vacuno, especialmente amplia | Cuoio di bovina, particolarmente ampio | Okseleder, særlig bred

oliv | olive | olive | oliva | oliva | olivenfarvet

35 207358 40 207359

45 207360 50 207361

55 207362 60 207363

65 207364

cognac | cognac | cognac | coñac | cognac | cognac

35 207365 40 207366

45 207367 50 207368

55 207369 60 207370

65 207371

dunkelbraun | dark brown | marron foncé | marrón oscuro | marrone scuro | mørkebrun

35 207372 40 207373

45 207374 50 207375

55 207376 60 207377

65 207378

schwarz | black | noir | negro | nero | sort

35 207379 40 207380

45 207381 50 207382

55 207383 60 207384

65 207385

⇒	■i	↔	↔
XS	35	26 – 31 cm	2,5 cm
S	40	32 – 36 cm	2,5 cm
S	45	36 – 40 cm	3,0 cm
S-M	50	41 – 46 cm	3,0 cm
M	55	40 – 48 cm	3,5 cm
M-L	60	46 – 53 cm	3,5 cm
L	65	50 – 58 cm	3,5 cm





Alu-Strong

MADE
IN
GERMANY



	↔	↔
M	30 – 45 cm	1,5 cm
L	40 – 55 cm	2,0 cm
XL	45 – 65 cm	2,5 cm

Halsung AALBORG ALU-STRONG

Collar | Collier | Collar | Collare | Halsbånd

Rindsleder, besonders weich, Steckverschluss aus Aluminium, Metall-Schieber | *Cow leather, extra soft, buckle made of aluminum, metal slide* | Cuir de bœuf, extra souple, fermeture à clips pratique d'aluminium, coulisseau en métal | *Cuero de vacuno, extrasuave, cierre a presión de aluminio, pasador metálico* | Cuoio di bovina, extra morbida, chiusura a scatto in alluminio, fibbia di metallo | *Okselader, ekstra blødt, kliklås af aluminium, metalspændet*

orange | orange | orange | naranja | arancione | orange

M 207349 L 207350

XL 207351

oliv | olive | olive | oliva | oliva | olivenfarvet

M 207352 L 207353

XL 207354

cognac | cognac | cognac | coñac | cognac | cognac

M 207355 L 207356

XL 207357

steingrau | stone grey | gris pierre | gris piedra | grigio pietra | stengrå

M 207346 L 207347

XL 207348

Windhundhalsband AALBORG

Greyhound collar | Collier de lévrier | Collar para galgo | Collare levriero | Vindhund-halsbånd

Rindsleder | *Cow leather* | Cuir de boeuf | *Cuero de vacuno* | Cuoio di bovina | *Okselader*

oliv | olive | olive | oliva | oliva | olivenfarvet

32 207341 37 207342

42 207343 47 207344

52 207345

cognac | cognac | cognac | coñac | cognac | cognac

32 207336 37 207337

42 207338 47 207339

52 207340

schwarz | black | noir | negro | nero | sort

32 207331 37 207332

42 207333 47 207334

52 207335



MADE
IN
GERMANY



	↗	↔	↔
32	XS	23 – 28 cm	4,2 cm
37	XS-S	28 – 33 cm	5,0 cm
42	S	33 – 38 cm	6,0 cm
47	S-M	36 – 42 cm	6,5 cm
52	M	41 – 47 cm	6,5 cm

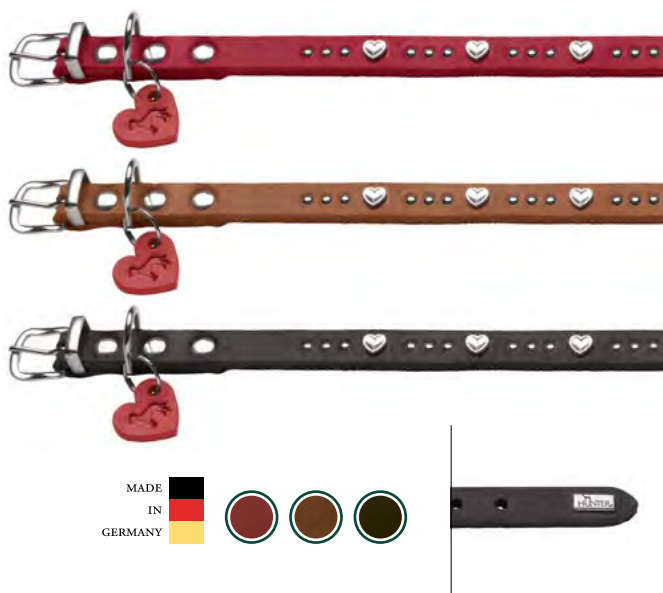

■i	⇌	↔	↔
27	XS	24–29 cm	1,2 cm
32	XS–S	28–33 cm	1,4 cm
37	XXS–XS	19–24 cm	1,2 cm

Halsband AALBORG HEARTS

Collar | Collier | Collar | Collare | Halsbånd

Rindsleder | Cow leather | Cuir de bœuf | Cuero de vacuno | Cuoio di bovina | Okselæder

rot | red | rouge | rojo | rosso | rød

27 201971 32 201972

37 201973

cognac | cognac | cognac | coñac | cognac | cognac

27 201968 32 201969

37 201970

schwarz | black | noir | negro | nero | sort

27 201965 32 201966

37 201967

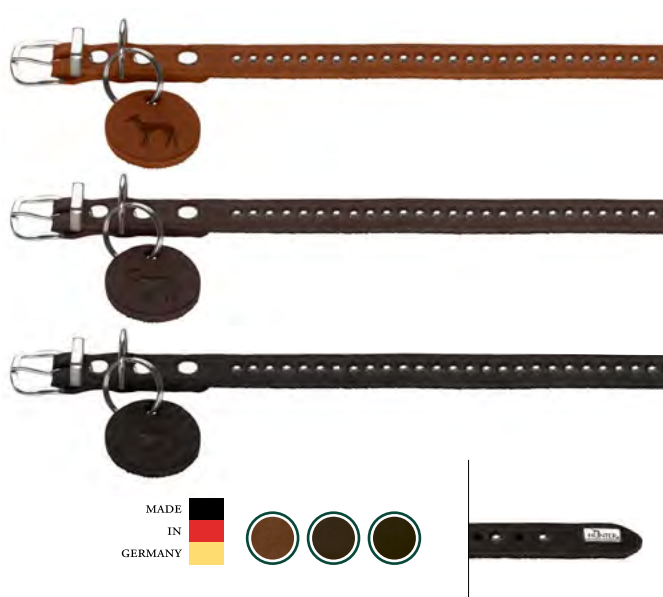

■i	⇌	↔	↔
27	XXS–XS	19–24 cm	1,2 cm
32	XS	24–29 cm	1,2 cm
37	XS–S	28–33 cm	1,4 cm
42	S	33–39 cm	1,6 cm

Halsband AALBORG STYLE

Collar | Collier | Collar | Collare | Halsbånd

Rindsleder | Cow leather | Cuir de boeuf | Cuero de vacuno | Cuoio di bovina | Okselæder

cognac | cognac | cognac | coñac | cognac | cognac

27 69505 32 69506

37 69507 42 69508

dunkelbraun | dark brown | marron foncé | marrón oscuro | marrone scuro | mørkebrun

27 69509 32 69510

37 69511 42 69512

schwarz | black | noir | negro | nero | sort

27 69513 32 69514

37 69515 42 69516





Halsung mit Kette AALBORG

Collar with chain | Collier avec chaîne | Collar con catena | Collare con catena | Halsbånd med kæde

Rindsleder, mit Zugstopp (Kette) | Cow leather, with no-choke harness (chain) | Cuir de bœuf, avec tirette (chaîne) | Cuero de vacuno, con tope (catena) | Cuoio di bovina, con fermo a strappo (catena) | Okseleder, med trækstop (kæde)

schwarz | black | noir | negro | nero | sort

M	68288		M-L	68289	
L	68290		L-XL	68291	

⇌	↔	↔
M	max. 45 cm	2,0 cm
M-L	max. 50 cm	2,5 cm
L	max. 55 cm	2,5 cm
L-XL	max. 60 cm	2,5 cm



Halsband AALBORG SOUL

Collar | Collier | Collar | Collare | Halsbånd

Rindsleder | Cow leather | Cuir de bœuf | Cuero de vacuno | Cuoio di bovina | Okseleder

rot | red | rouge | rojo | rosso | rød

25	69056		30	69057	
35	69058		40	69059	
45	69060		50	69061	

cognac | cognac | cognac | coñac | cognac | cognac

25	69062		30	69063	
35	69064		40	69065	
45	69066		50	69067	

schwarz | black | noir | negro | nero | sort

25	69050		30	69051	
35	69052		40	69053	
45	69054		50	69055	

■	⇌	↔	↔
25	XXS-XS	16 - 20 cm	1,5 cm
30	XS	21 - 25 cm	1,5 cm
35	XS-S	26 - 30 cm	2,0 cm
40	XS-S	30 - 34 cm	2,0 cm
45	S	30 - 38 cm	2,5 cm
50	S-M	36 - 41 cm	2,5 cm





Geschirr AALBORG

Harness | Harnais | Arnés | Pettorina | Sele

Rindsleder, 5-fache Verstellmöglichkeit | Cow leather, 5-fold adjustable | Cuir de boeuf, 5 possibilités de réglage | Cuero de vacuno, 5 posibilidades de ajuste | Cuoio di bovina, 5 possibilità di regolazione | Okselæder, 5-trins indstilling

cognac | cognac | cognac | coñac | cognac | cognac

XS 67334 S-M/1 67335

S-M/2 67336 M-L/1 67337

M-L/2 67338

dunkelbraun | dark brown | marron foncé | marrón oscuro | marrone scuro | mørkebrun

XS 67329 S-M/1 67330

S-M/2 67331 M-L/1 67332

M-L/2 67333

schwarz | black | noir | negro | nero | sort

XS 67324 S-M/1 67325

S-M/2 67326 M-L/1 67327

M-L/2 67328

5-fach
verstellbar
5-fold adjustable



⇒	↔*	↔.	↔
XS	38 – 52 cm	36 – 50 cm	1,5 cm
S-M/1	44 – 56 cm	47 – 63 cm	2,0 cm
S-M/2	51 – 64 cm	52 – 72 cm	2,5 cm
M-L/1	58 – 80 cm	63 – 90 cm	2,5 cm
M-L/2	62 – 90 cm	65 – 95 cm	2,5 cm

PerfectFIT

Mit leichten Kunststoffschnallen
With light plastic clasps

Materialmix aus Rindsleder
und Nylon
*Combination of cowhide
leather and nylon*

Verschlüsse unterpolstert
Closures padded

Breite Lederpolsterung
Wide leather padding

5-fach verstellbar
5-fold adjustable



Tradition trifft Innovation und Moderne! Was wunderbar die Werte von HUNTER widerspiegelt, beschreibt ebenso perfekt das neue Geschirr AALBORG MIXED. Die Kombination aus hochwertigem Leder und strapazierfähigem Nylon vereint die Vorteile beider Materialien und sieht dabei auch noch super stylish aus.

Tradition meets innovation and contemporary style! That perfectly describes both HUNTER's values and the new AALBORG MIXED harness. Pairing high-quality leather with durable nylon combines the advantages of each material and looks super stylish.



Geschirr AALBORG MIXED

Harness | Harnais | Arnés | Pettorina | Sele

Rindsleder/Nylon, 5-fache Verstellmöglichkeit | Cow leather/Nylon, 5-fold adjustable | Cuir de bœuf/Nylon, 5 possibilités de réglage | Cuero de vacuno/Nylon, 5 posibilidades de ajuste | Cuoio di bovina/Nylon, 5 possibilità di regolazione | Okselader/Nylon, 5-trins indstilling

rot/grau | red/grey | rouge/gris | rojo/gris | rosso/grigio | rød/grå

XS-S 68488 S 68489

M 68490 M-L 68491

oliv/grau | olive/grey | olive/gris | oliva/gris | oliva/grigio | olivenfarvet/grå

XS-S 68284 S 68285

M 68286 M-L 68287

cognac/grau | cognac/grey | olivecognac | cognac/gris | cognac/grigio | cognac/grå

XS-S 68276 S 68277

M 68278 M-L 68279

dunkelbraun/grau | dark brown/grey | marron foncé/gris | marrón oscuro/gris | marrone scuro/grigio | mørkebrun/grå

XS-S 68272 S 68273

M 68274 M-L 68275

schwarz/grau | black/grey | noir/gris | negro/gris | nero/grigio | sort/grå

XS-S 68280 S 68281

M 68282 M-L 68283

5-fach
verstellbar
5-fold adjustable

↕	↔*	↔.	↔
XS-S	40 – 50 cm	38 – 51 cm	1,5 cm
S	50 – 66 cm	46 – 67 cm	2,0 cm
M	55 – 67 cm	56 – 81 cm	2,5 cm
M-L	61 – 85 cm	63 – 96 cm	2,5 cm





STEP-IN

Geschirr DIMARO

Harness | Harnais | Arnés | Pettorina | Sele

Rindsleder | Cow leather | Cuir de bœuf | Cuero de vacuno | Cuoio di bovina | Okselader

cognac | cognac | cognac | coñac | cognac | cognac

XS-S 68206 S-M 68207

M 68208

schwarz | black | noir | negro | nero | sort

XS-S 68200 S-M 68201

M 68202



MADE
IN
GERMANY

≙	↔*	↔.
XS-S	40 - 45 cm	40 - 55 cm
S-M	45 - 50 cm	48 - 69 cm
M	54 - 59 cm	54 - 72 cm



Verstellbare Führleine AALBORG

Training leash | Laisse réglable | Correa ajustable | Guinzaglio da passeggio regolabile | Justerbar line

Rindsleder, 3-fache Verstellmöglichkeit | *Cow leather, 3-fold adjustable* | Cuir de boeuf, 3 possibilités de réglage | *Cuero de vacuno, 3 posibilidades de ajuste* | Cuoio di bovina, 3 possibilità di regolazio | *Okselader, 3-trins indstilling*

cognac | cognac | cognac | coñac | cognac | cognac

10/200 69216 13/200 69217

15/200 69218 20/200 69219

dunkelbraun | dark brown | marron foncé | marrón oscuro | marrone scuro | mørkebrun

10/200 69220 13/200 69221

15/200 69222 20/200 69223

schwarz | black | noir | negro | nero | sort

10/200 69224 13/200 69225

15/200 69226 20/200 69227



Verstellbare Führleine geflochten AALBORG

Training leash braided | Laisse réglable tressée | Correa ajustable trenzado | Guinzaglio da passeggio regolabile intrecciato | Justerbar line flettet

Rindsleder, handgeflochten | *Cow leather, hand-braided* | Cuir de boeuf, cousu à la main | *Cuero de vacuno, trenzada a mano* | Cuoio di bovina, intrecciato a mano | *Okselader, håndvevet*

cognac | cognac | cognac | coñac | cognac | cognac

15/200 204383 20/200 204384

dunkelbraun | dark brown | marron foncé | marrón oscuro | marrone scuro | mørkebrun

15/200 204385 20/200 204386

schwarz | black | noir | negro | nero | sort

15/200 204387 20/200 204388



Raffiniert verarbeitet
Refined finish



Führleine

Leash | Laisse | Correa | Guinzaglio da passeggio | Line | Leiband

Rindsleder | *Cow leather* | Cuir de bœuf | *Cuero de vacuno* | Cuoio di bovina | *Okselæder* | In zekere zin vertegenwoordigt deze riem de volgende generatie zacht en vol rundleder. Dankzij het bijzonder hoge vetgehalte en de natuurlijke looiing is het ook bestand tegen hoge trekkrachten en dus bijzonder geschikt voor hondensport. Het leer is namelijk niet alleen extreem robuust. De hondenriem ligt ook extreem soepel in de hand. Let op: Ons leer wordt zo milieuvriendelijk mogelijk geproduceerd. Bij geverfd leer kan aanvankelijk een lichte verkleuring optreden.

orange | orange | orange | naranja | arancione | orange

13/110 205090 16/100 205091

20/100 205092

rot | red | rouge | rojo | rosso | rød

13/110 68345 16/100 68346

20/100 68347

dunkelblau | dark blue | bleu foncé | azul oscuro | blu scuro | mørkeblå

13/110 68342 16/100 68343

20/100 68344

oliv | olive | olive | oliva | oliva | olivenfarvet

13/110 67299 16/100 67300

20/100 67301

cognac | cognac | cognac | coñac | cognac | cognac

13/110 66060 16/100 66061

20/100 66062

dunkelbraun | dark brown | marron foncé | marrón oscuro | marrone scuro | mørkebrun

13/110 66075 16/100 66076

20/100 66077

steingrau | stone grey | gris pierre | gris piedra | grigio pietra | stengrå

13/110 205077 16/100 205078

20/100 205079

schwarz | black | noir | negro | nero | sort

13/110 66041 16/100 66042

20/100 66043



Verstellbare Führleine

Training leash | Laisse réglable | Correa ajustable | Guinzaglio da passeggio regolabile | Justerbar line

Rindsleder, 3-fache Verstellmöglichkeit | *Cow leather, 3-fold adjustable* | Cuir de bœuf, 3 possibilités de réglage | *Cuero de vacuno, 3 posibilidades de ajuste* | Cuoio di bovina, 3 possibilità di regolazione | *Okselæder, trins indstilling*

natur | tan | nature | natural | naturale | natur

13/200 66032  16/200 66033 

20/200 66034 

orange | orange | orange | naranja | arancione | orange

13/200 205094  15/200 205095 

20/200 205096 

rot | red | rouge | rojo | rosso | rød

13/200 68351  16/200 68352 

20/200 68353 

dunkelblau | dark blue | bleu foncé | azul oscuro | blu scuro | mørkeblå

13/200 68348  16/200 68349 

20/200 68350 

oliv | olive | olive | oliva | oliva | olivenfarvet

13/200 67302  16/200 67303 

20/200 67304 

cognac | cognac | cognac | coñac | cognac | cognac

13/200 66063  16/200 66064 

20/200 66065 

dunkelbraun | dark brown | marron foncé | marrón oscuro | marrone scuro | mørkebrun

13/200 66078  16/200 66079 

20/200 66080 

steingrau | stone grey | gris pierre | gris piedra | grigio pietra | stengrå

13/200 205081  16/200 205082 

20/200 205083 

schwarz | black | noir | negro | nero | sort

13/200 66044  16/200 66045 

20/200 66046 





Stufenlos verstellbare Umhängeleine AALBORG

Individually adjustable neck leash | Laisse de cou réglable individuellement | Correa de cuello ajustable individualmente | Guinzaglio da collo regolabile individualmente | Individuelt justerbar halslenke

Rindsleder, durch Schieber stufenlos verstellbar | *Cow leather, infinitely adjustable by slider | Cuir de boeuf, réglable en continu par curseur | Cuero de vacuno, ajuste infinito por medio de la corredera | Cuoio di bovina, regolabile all'infinito tramite cursore | Okselæder, trinløst justerbar med skyderen*

dunkelbraun | dark brown | marron foncé | marrón oscuro | marrone scuro | mørkebrun

15/250 69635  20/250 69636 



Mit innovativem Leder-Schieber!

With innovative leather slider!

Durch den innovativen Schieber aus Leder lässt sich die 2,50m lange Leine in jeder beliebigen Position feststellen.

The innovative leather slider allows the 2,50m long leash to be locked in any position.



■
16 x 2 cm



■
13 x 10 x 5 cm ■■■
6 Stck. | pcs.

Leinenhalter BARRIT ALU-STRONG

Leash holder | Support de laisse | Soporte de línea | Porta guinzaglio | Lineholder | Lijnhouder

Rindsleder, Steckverschluss aus Aluminium, Leine schnell und einfach verstauen, unabhängig von der Länge, individuelle Befestigungsmöglichkeiten (Gürtel, Rucksack etc.) | Cow leather, buckle made of aluminium, Leash can be stowed away quickly and easily, regardless of length, individual fastening options (belt, rucksack, etc.) | Cuir de boeuf, fermeture à clips pratique d'aluminium, rangement rapide et facile de la laisse, quelle que soit sa longueur, possibilités de fixation individuelles (ceinture, sac à dos, etc.) | Cuero de vacuno, cierre a presión de aluminio, La correa se puede guardar rápida y fácilmente, independientemente de su longitud, con opciones de sujeción individuales (cinturón, mochila, etc.) | Cuoio di bovina, chiusura a scatto in alluminio, il guinzaglio può essere riposto in modo rapido e semplice, indipendentemente dalla lunghezza, con possibilità di fissaggio individuale (cintura, zaino, ecc.) | Okseleder, kliklås af aluminium, Snoren kan hurtigt og nemt gemmes væk, uanset længde, individuelle fastgørelsesmuligheder (bælte, rygsæk osv.)
dunkelbraun | dark brown | marron foncé | marrón oscuro | marrone scuro | mørkebrun

69546

schwarz | black | noir | negro | nero | sort

69547

Kotbeutelspender VARDE

Waste bag dispenser | Distributeur de sac sanitaire | Dispensador de bolsas para excrementos | Distributore di sacchetti per escrementi | Lorteposeautomat

Rindsleder, mit praktischem Karabiner zur variablen Befestigung, befüllbar mit handelsüblichen Kotbeutel-Rollen (1 Rolle bereits im Lieferumfang enthalten) | Cowhide, with practical carabiner for variable attachment, can be filled with standard waste bag rolls (1 roll already included) | Cuir de boeuf, avec mousqueton pratique pour une fixation variable, peut être rempli avec des rouleaux de sacs à crottes usuels (1 rouleau déjà inclus dans la livraison) | Piel de vaca, con práctico mosquetón para fijación variable, se puede rellenar con rollos de bolsa de caca estándar (1 rollo ya incluido) | In pelle di mucca, con pratico moschettoni per il fissaggio variabile, può essere riempito con rotoli di sacchetti di cacca standard (1 rotolo già incluso) | Koskind, med praktisk karabinhage til variabel fastgørelse, kan fyldes med standardposeruller (1 rulle er allerede inkluderet)

dunkelbraun | dark brown | marron foncé | marrón oscuro | marrone scuro | mørkebrun

69548

schwarz | black | noir | negro | nero | sort

69549

Ein echter Problemlöser

A real problem solver

Der Leinenhalter wird ganz einfach um die zusammengelegte Leine geschlungen und mit dem robusten Klickverschluss aus Aluminium verschlossen. Die stufenlos weitenverstellbare Schlaufe aus wunderbar weichem Rindsleder kann mit Hilfe des hochwertigen Rings mit leicht gängigem Verschluss praktisch und schnell am Hosenbund, Gürtel oder Rucksack befestigt und sicher verstaut mitgeführt werden, ohne dass sie im Weg baumelt oder man die Hände voll hat.

The lead holder is simply looped around the folded lead and closed with the robust aluminium click fastener. The infinitely adjustable loop made of wonderfully soft cowhide leather can be quickly and practically attached to the waistband, belt or rucksack using the high-quality ring with an easy-to-use fastener and stowed away safely without dangling in the way or getting your hands full.





Size	Neck	Length	Width
40	S	28 – 34 cm	2,0 cm
45	S	33 – 39 cm	2,0 cm
50	S-M	37 – 45 cm	2,5 cm
55	M	42 – 50 cm	2,5 cm
60	M-L	47 – 55 cm	2,5 cm
65	L	52 – 60 cm	2,5 cm

Halsband LEMVIG

Collar | Collier | Collar | Collare | Halsbånd

Rindsleder | Cow leather | Cuir de boeuf | Cuero de vacuno | Cuoio di bovina | Okselæder

orange/dunkelbraun | orange/dark brown | orange/marron foncé | naranja/marrón oscuro | arancione/marrone scuro | orange/dunkelbraun

40 207299 45 207300

50 207301 55 207302

60 207303 65 207304

rot/dunkelblau | red/dark blue | rouge/bleu foncé | rojo/azul oscuro | rosso/blu scuro | rød/mørkeblå

40 207323 45 207324

50 207325 55 207326

60 207327 65 207328

lila/dunkelblau | purple/dark blue | violet/bleu foncé | morado/azul oscuro | viola/blu scuro | lilla/mørkeblå

40 207307 45 207308

50 207309 55 207310

60 207311 65 207312

cognac/oliv | cognac/olive | cognac/olive | coñac/oliva | cognac/oliva | cognac/olivenfarvet

40 207315 45 207316

50 207317 55 207318

60 207319 65 207320

schwarz/steingrau | black/stone grey | noir/gris pierre | negro/gris piedra | nero/grigio pietra | sort/stengrà

40 207291 45 207292

50 207293 55 207294

60 207295 65 207296



Verstellbare Führleine LEMVIG

Training leash | Laisse réglable | Correa ajustable | Guinzaglio da passeggio regolabile | Justerbar line

Rindsleder, 3-fache Verstellmöglichkeit | *Cow leather, 3-fold adjustable* | Cuir de boeuf, 3 possibilités de réglage | *Cuero de vacuno, 3 posibilidades de ajuste* | Cuoio di bovina, 3 possibilità di regolazio | *Okselæder, 3-trins indstilling*



Passende Leinen mit smartem Scherenkarabiner.
Matching leashes with smart scissor carabiner.

orange/dunkelbraun | orange/dark brown | orange/marron foncé | naranja/marrón oscuro | arancione/marrone scuro | orange/dunkelbraun

15/200 207305 20/200 207306

rot/dunkelblau | red/dark blue | rouge/bleu foncé | rojo/azul oscuro | rosso/blu scuro | rød/mørkeblå

15/200 207329 20/200 207330

lila/dunkelblau | purple/dark blue | violet/bleu foncé | morado/azul oscuro | viola/blu scuro | lilla/mørkeblå

15/200 207313 20/200 207314

cognac/oliv | cognac/olive | cognac/olive | coñac/oliva | cognac/oliva | cognac/olivfarvet

15/200 207321 20/200 207322

schwarz/steingrau | black/stone grey | noir/gris pierre | negro/gris piedra | nero/grigio pietra | sort/stengrå

15/200 207297 20/200 207298

Stil, Langlebigkeit und Komfort

Style, durability and comfort



Stil, Langlebigkeit und Komfort – diese nahezu perfekte Kombination findet sich in unserer exklusiven Serie LEMVIG wieder. Durch die Fertigung aus erstklassigem Fettleder überzeugen Halsband und Leine in ihrer langen Haltbarkeit, Widerstandsfähigkeit und bieten jedem Hund einen angenehmen Tragekomfort. LEMVIG ist in mehreren trendigen Farbkombinationen erhältlich und wird dadurch zu einem echten Hingucker. Durch feine Details und einen präzise verarbeiteten Lederanhänger wird das Design abgerundet und die hohe Qualität deutlich hervorgehoben.

Style, durability and comfort - this almost perfect combination can be found in our exclusive LEMVIG range. Made from first-class oiled leather, the collar and lead are impressively durable, hard-wearing and comfortable for every dog. LEMVIG collar is available in several trendy colour combinations, making it a real eye-catcher. Fine details and a precisely crafted leather pendant round off the design and clearly emphasise the high quality.

Spannende Farbkombinationen

Exciting colour combinations

**KEIN
»KLIMPERN«
MEHR**
No more »jingling«!

auch als
Clipstrip
12/Clipstrip

farblich sortiert
assorted colours

MADE IN GERMANY

→	∅	
S	4,3 cm	6 Stck. pcs.
M	4,8 cm	6 Stck. pcs.
	■	
Clipstrip	95 x 12 cm	12 Stck. pcs.

Anhänger Hundemarken-Etui AALBORG

*Dog Tag Case Pendant | Pendentif Étui pour marques de chien
| Colgante Estuche Etiqueta de Perro | Ciondolo a forma di
medaglietta per cani | Vedhæng til hundetageske*

Rindsleder, für Adress- und Steuermarken, schützt die Marke und verhindert Klimpern, mit Schlüsselring | *Cowhide leather, for address and tax tags, protects the stamp and prevents jingling, with key ring* | Cuir de bœuf, pour timbres-adresses et timbres fiscaux, protège le timbre et empêche le tintement, avec anneau pour clés | *Piel de vaca, para sellos de direcciones e impuestos, protege el sello y evita el tintino, con llavero* | In pelle di vacchetta, per timbri di indirizzo e fiscali, protegge il timbro e impedisce il tintinnio, con anello portachiavi | *Okselæder, til adresse- og skattefrimærker, beskytter frimærket og forhindrer klirren, med nøglering*

Clipstrip / Assorted colours

68300

rot | red | rouge | rojo | rosso | rød

S 69995 M 69996

cognac | cognac | cognac | coñac | cognac | cognac

S 68294 M 68295

dunkelbraun | dark brown | marron foncé | marrón oscuro | marrone scuro
| mørkebrun

S 68296 M 68297

schwarz | black | noir | negro | nero | sort

S 68298 M 68299





Halsband VIBORG mit Halter für Apple AirTag

Collar with holder for Apple AirTag | Collier avec support pour Apple AirTag | Collar con soporte para Apple AirTag | Collare con supporto per Apple AirTag | Halsbånd med holder til Apple AirTag

Rindsleder, mit passgenauer Halterung für Apple AirTag (AirTag nicht im Lieferumfang enthalten) | Cow leather, with customised holder for Apple AirTag (AirTag not included) | Cuir de boeuf, avec support adapté pour Apple AirTag (AirTag non compris dans la livraison) | Cuero de vacuno, con soporte personalizado para Apple AirTag (AirTag no incluido) | Cuoio di bovina, con supporto personalizzato per Apple AirTag (AirTag non incluso) | Okselæder, med skræddersyet holder til Apple AirTag (AirTag medfølger ikke)

cognac | cognac | cognac | coñac | cognac | cognac

45 207386 50 207387

55 207388 60 207389

schwarz | black | noir | negro | nero | sort

45 207391 50 207392

55 207393 60 207394

cm	↔	↔
45	S	32 – 38 cm
50	S–M	37 – 43 cm
55	M	42 – 48 cm
60	M–L	47 – 53 cm

Halter VIBORG für Apple AirTag

Holder for Apple AirTag | Support pour Apple AirTag | Soporte para Apple AirTag | Supporto per Apple AirTag | Holder til Apple AirTag

Rindsleder, mit passgenauer Halterung für Apple AirTag (AirTag nicht im Lieferumfang enthalten), individuell einsetzbar | Cow leather, with customised holder for Apple AirTag (AirTag not included), can be used individually | Cuir de boeuf, avec support adapté pour Apple AirTag (AirTag non compris dans la livraison), utilisable individuellement | Cuero de vacuno, con soporte personalizado para Apple AirTag (AirTag no incluido), puede utilizarse individualmente | Cuoio di bovina, con supporto personalizzato per Apple AirTag (AirTag non incluso), può essere utilizzato singolarmente | Okselæder, med skræddersyet holder til Apple AirTag (AirTag medfølger ikke), kan bruges individuelt

cognac | cognac | cognac | coñac | cognac | cognac

207390

schwarz | black | noir | negro | nero | sort

207395





Halsband MALTA

Collar | Collier | Collar | Collare | Halsbånd

Rindsleder | Cow leather | Cuir de boeuf | Cuero de vacuno | Cuoio di bovina | Okseleder

magenta/schwarz | magenta/black | magenta/noir | magenta/negro | magenta/nero | magenta/sort

37 204842 42 204843

47 204844 50 204845

55 204846 60 204847

petrol/schwarz | teal/black | pétrole/noir | petróleo/negro | petrolio/nero | petrol/sort

37 204826 42 204827

47 204828 50 204829

55 204830 60 204831

steingrau/schwarz | stone grey/black | gris pierre/noir | gris piedra/negro | grigio pietra/nero | stengrà/sort

37 204834 42 204835

47 204836 50 204837

55 204838 60 204839

mm	⇒	↔	↔
37	XS-S	29 – 33 cm	2,6 cm
42	S	34 – 38 cm	2,6 cm
47	S-M	37 – 42 cm	2,8 cm
50	S-M	36 – 43 cm	3,9 cm
55	M	41 – 48 cm	3,9 cm
60	L	46 – 53 cm	3,9 cm



Verstellbare Führleine MALTA

Training leash | Laisse réglable | Correa ajustable | Guinzaglio da passeggio regolabile | Justerbar line

Rindsleder, 3-fache Verstellmöglichkeit | Cow leather | Cuir de boeuf, 3 possibilités de réglage | Cuero de vacuno, 3 posibilidades de ajuste | Cuoio di bovina, 3 possibilità di regolazione | Okseleder, 3-trins indstilling

magenta/schwarz | magenta/black | magenta/noir | magenta/negro | magenta/nero | magenta/sort

13/200 204848 18/200 204849

petrol/schwarz | teal/black | pétrole/noir | petróleo/negro | petrolio/nero | petrol/sort

13/200 204832 18/200 204833

steingrau/schwarz | stone grey/black | gris pierre/noir | gris piedra/negro | grigio pietra/nero | stengrà/sort

13/200 204840 18/200 204841



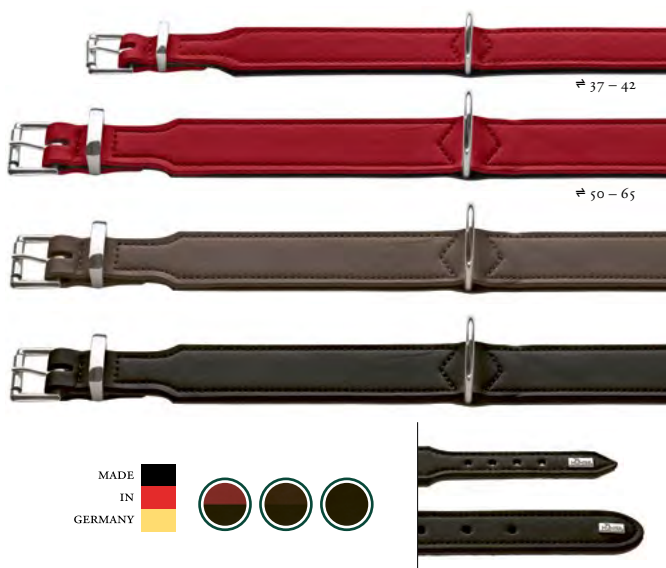

№	↗	↔	↔
37	XS-S	29 – 33 cm	2,6 cm
42	S-M	34 – 38 cm	2,6 cm
50	S-M	36 – 43 cm	3,9 cm
55	M	41 – 48 cm	3,9 cm
60	M-L	46 – 53 cm	3,9 cm
65	L	51 – 58 cm	3,9 cm

Halsband BASIC

Collar | Collier | Collar | Collare | Halsbånd

beschichtetes Spaltleder | *coated split leather* | cuir refendu enduit | *serraje revestido* | cuoio rivestito | *coated spaltleder*

rot/schwarz | red/black | rouge/noir | rojo/negro | rosso/nero | rød/sort

37 46945 42 46946

50 46947 55 46948

60 46949 65 46950

braun/schwarz | brown/black | marron/noir | marrón/negro | marrone/nero | brun/sort

37 46952 42 46953

50 46954 55 46955

60 46956 65 46957

schwarz | black | noir | negro | nero | sort

37 46959 42 46960

50 46961 55 46962

60 46963 65 46964



Führleine BASIC

Leash | Laisse | Correa | Guinzaglio da passeggio | Line

beschichtetes Spaltleder | *coated split leather* | cuir refendu enduit | *serraje revestido* | cuoio rivestito | *coated spaltleder*

rot/schwarz | red/black | rouge/noir | rojo/negro | rosso/nero | rød/sort

13/110 46965 18/100 46966

braun/schwarz | brown/black | marron/noir | marrón/negro | marrone/nero | brun/sort

13/110 46967 18/100 46968

schwarz | black | noir | negro | nero | sort

13/110 46969 18/100 46970



Verstellbare Führleine BASIC

Training leash | Laisse réglable | Correa ajustable | Guinzaglio da passeggio regolabile | Justerbar line

beschichtetes Spaltleder, 3-fache Verstellmöglichkeit | *coated split leather, 3-fold adjustable* | cuir refendu enduit, 3 possibilités de réglage | *serraje revestido, 3 posibilidades de ajuste* | cuoio rivestito, 3 possibilità di regolazione | *coated spaltleder, 3-trins indstilling*

rot/schwarz | red/black | rouge/noir | rojo/negro | rosso/nero | rød/sort

13/200 46971 18/200 46972

braun/schwarz | brown/black | marron/noir | marrón/negro | marrone/nero | brun/sort

13/200 46973 18/200 46974

schwarz | black | noir | negro | nero | sort

13/200 46975 18/200 46976



Kunstleder

— *Artificial leather* —

Kunstleder ist der moderne Alleskönner unter den Materialien. In Optik und Haptik kaum von Echtleder zu unterscheiden, ist es besonders strapazierfähig und bietet auch eine Alternative für Hundehalter, die einen veganen Lebensstil bevorzugen und trotzdem nicht auf die faszinierende Ausstrahlung von Leder verzichten möchten.

Artificial leather is the modern all-rounder of materials. Barely distinguishable from real leather in look and feel, this material is particularly durable and provides an alternative for dog owners who favour a vegan lifestyle yet at the same time don't want to give up the captivating allure of leather.



MADE
IN
GERMANY



	⇔	↔
M	30 – 45 cm	1,5 cm
L	40 – 55 cm	2,5 cm
XL	45 – 65 cm	2,5 cm

Halsung AMALFI ALU-STRONG

Collar | Collier | Collar | Collare | Halsbånd

Kunstleder, Rindnappa-Optik, vegan, stufenlos verstellbar, Steckverschluss aus Aluminium, Metall-Schieber | *Faux leather, cowhide nappa look, vegan, individually adjustable, buckle made of aluminium, metal slide* | Similicuir, aspect nappa bovin, végétalien, réglable en continu, fermeture à clips pratique d'aluminium, coulisseau en métal | *Cuero artificial, acabado napa de vaca, vegano, infinitamente ajustable, cierre a presión de aluminio, pasador metálico* | Similpelle, effetto nappa di vacchetta, vegano, regolabile in continuo, chiusura a scatto in alluminio, fibbia di metallo | *Kunstleder, nappaoptik, vegansk, trinløs indstilling, plug-in-fastgørelse i aluminium, metalskyder*

beige | tan | beige | beige | beige | beige

M 205116 L 205117

XL 205118

gelb | yellow | jaune | amarillo | giallo | gul

M 205158 L 205159

XL 205160

marine | navy | marine | marina | blu marino | marineblå

M 205172 L 205173

XL 205174

grün | green | vert | verde | verde | grøn

M 205144 L 205145

XL 205146

schokobraun | chocolate brown | brun chocolat | marrón chocolate | marrone cioccolato | chokoladebrun

M 205130 L 205131

XL 205132





cm	Size	cm	cm
35	XS	24 – 30	1,8
40	S	28 – 34	1,8
45	S	30 – 38	2,8
50	S-M	35 – 42	2,8
55	M	36 – 46	3,5
60	M-L	42 – 52	3,5

Halsband AMALFI

Collar | Collier | Collar | Collare | Halsbånd

Kunstleder, Rindnappa-Optik, vegan | *Faux leather, cowhide nappa look, vegan* | Similicuir, aspect nappa bovin, végétalien | *Cuero artificial, acabado napa de vaca, vegano* | Similpelle, effetto nappa di vacchetta, vegano | *Kunstleder, nappaoptik, 100% vegansk*

beige | tan | beige | beige | beige | beige

35	205110	40	205111
45	205112	50	205113
55	205114	60	205115

gelb | yellow | jaune | amarillo | giallo | gul

35	205152	40	205153
45	205154	50	205155
55	205156	60	205157

marine | navy | marine | marina | blu marino | marineblå

35	205166	40	205167
45	205168	50	205169
55	205170	60	205171

grün | green | vert | verde | verde | grøn

35	205138	40	205139
45	205140	50	205141
55	205142	60	205143

schokobraun | chocolate brown | brun chocolat | marrón chocolate | marrone cioccolato | chokoladebrun

35	205124	40	205125
45	205126	50	205127
55	205128	60	205129



cm	Size	cm	cm
15/110	XS	24 – 30	1,8
20/100	S	28 – 34	1,8
20/100	S	30 – 38	2,8
20/100	S-M	35 – 42	2,8
20/100	M	36 – 46	3,5
20/100	M-L	42 – 52	3,5

Führleine AMALFI

Leash | Laisse | Correa | Guinzaglio da passeggio | Line

Kunstleder, Rindnappa-Optik, vegan | *Faux leather, cowhide nappa look, vegan* | Similicuir, aspect nappa bovin, végétalien | *Cuero artificial, acabado napa de vaca, vegano* | Similpelle, effetto nappa di vacchetta, vegano | *Kunstleder, nappaoptik, vegansk*

beige | tan | beige | beige | beige | beige

15/110	205119	20/100	205120
15/110	205161	20/100	205162

marine | navy | marine | marina | blu marino | marineblå

15/110	205175	20/100	205176
15/110	205147	20/100	205148

schokobraun | chocolate brown | brun chocolat | marrón chocolate | marrone cioccolato | chokoladebrun

15/110	205133	20/100	205134
--------	--------	--------	--------



Verstellbare Führleine AMALFI

Training leash | Laisse réglable | Correa ajustable | Guinzaglio da passeggio regolabile | Justerbar line

Kunstleder, Rindnappa-Optik, vegan, 3-fache Verstellmöglichkeit | *Faux leather, cowhide nappa look, vegan, 3-fold adjustable* | Similicuir, aspect nappa bovin, végétalien, 3 possibilités de réglage | *Cuero artificial, acabado napa de vaca, vegano, 3 posibilidades de ajuste* | Similpelle, effetto nappa di vacchetta, vegano, 3 possibilità di regolazione | *Kunstleder, nappaoptik, vegansk, 3-trins indstilling*

beige | tan | beige | beige | beige | beige

15/200 205122  20/200 205123 

gelb | yellow | jaune | amarillo | giallo | gul

15/200 205164  20/200 205165 

marine | navy | marine | marina | blu marino | marineblå

15/200 205178  20/200 205179 

grün | green | vert | verde | verde | grøn

15/200 205150  20/200 205151 

schokobraun | chocolate brown | brun chocolat | marrón chocolate |
marrone cioccolato | chokoladebrun

15/200 205136  20/200 205137 



Verstellbare Führleine ROUND AMALFI

Training leash | Laisse réglable | Correa ajustable | Guinzaglio da passeggio regolabile | Justerbar line

Kunstleder, Rindnappa-Optik, vegan, 3-fache Verstellmöglichkeit, robuste und reißfeste Nyloneinlage | *Faux leather, cowhide nappa look, vegan, 3-fold adjustable, strong and resistant nylon rope inside* | Similicuir, aspect nappa bovin, végétalien, 3 possibilités de réglage, garniture en nylon robuste et anti-déchirure | *Cuero artificial, acabado napa de vaca, vegano, 3 posibilidades de ajuste, almohadilla de nylon fuerte y resistente* | Similpelle, effetto nappa di vacchetta, vegano, 3 possibilità di regolazione, rinforzo in nylon robusto e antistrappo | *Kunstleder, nappaoptik, vegansk, 3-trins indstilling, robust og rivefast nylon-indlæg*

beige | tan | beige | beige | beige | beige

10/200 205121 

gelb | yellow | jaune | amarillo | giallo | gul

10/200 205163 

marine | navy | marine | marina | blu marino | marineblå

10/200 205177 

grün | green | vert | verde | verde | grøn

10/200 205149 

schokobraun | chocolate brown | brun chocolat | marrón chocolate |
marrone cioccolato | chokoladebrun

10/200 205135 



↕	↔	↔
M	30 – 45 cm	1,5 cm
L	40 – 55 cm	2,5 cm
XL	45 – 65 cm	2,5 cm



↕	⇒	↔	
35	XS	24 – 30 cm	2,2 cm
40	S	28 – 34 cm	2,2 cm
45	S	30 – 38 cm	2,8 cm
50	S-M	35 – 42 cm	2,8 cm
55	M	36 – 46 cm	2,8 cm
60	M-L	42 – 52 cm	3,5 cm

Halsung SOFIA ALU-STRONG

Collar | Collier | Collar | Collare | Halsbånd

Kunstleder, vegan, Rindnappa-Optik, stufenlos verstellbar, mit Steckverschluss aus Aluminium, mit Metall-Schieber | *Faux leather, vegan, cowhide nappa look, infinitely adjustable, with aluminium plug fastener, with metal slider* | Similicuir, végétalien, aspect nappa bovin, réglable en continu, avec fermeture enfichable en aluminium, avec curseur en métal | *Cuero artificial, vegano, acabado napa de vaca, regulable sin escalonamiento, con cierre de aluminio, con corredera metálica* | Similpelle, vegana, effetto nappa di vacchetta, regolabile in continuo, con fissaggio a spina in alluminio, con cursore in metallo | *Kunstleder, vegansk, koskind med nappa-look, trinløs justering, med trykknaptlukning i aluminium, med metalskyder*

rot | red | rouge | rojo | rosso | rød

M 205198 L 205199

XL 205200

himbeer | raspberry | framboise | frambuesa | lampone | hindbær

M 205186 L 205187

XL 205188

braun | brown | marron | marrón | marrone | brun

M 205210 L 205211

XL 205212

schwarz | black | noir | negro | nero | sort

M 205222 L 205223

XL 205224

Halsband SOFIA

Collar | Collier | Collar | Collare | Halsbånd

Kunstleder, vegan, Rindnappa-Optik | *Faux leather, vegan, cowhide nappa look* | Similicuir, végétalien, aspect nappa bovin | *Cuero artificial, vegano, acabado napa de vaca* | Similpelle, vegana, effetto nappa di vacchetta | *Kunstleder, vegansk, nappaoptik*

rot | red | rouge | rojo | rosso | rød

35 205192 40 205193

45 205194 50 205195

55 205196 60 205197

himbeer | raspberry | framboise | frambuesa | lampone | hindbær

35 205180 40 205181

45 205182 50 205183

55 205184 60 205185

braun | brown | marron | marrón | marrone | brun

35 205204 40 205205

45 205206 50 205207

55 205208 60 205209

schwarz | black | noir | negro | nero | sort

35 205216 40 205217

45 205218 50 205219

55 205220 60 205221



Verstellbare Führleine SOFIA

Training leash | Laisse réglable | Correa ajustable | Guinzaglio da passeggio regolabile | Justerbar line

Kunstleder, vegan, Rindnappa-Optik, 3-fache Verstellmöglichkeit | *Faux leather, vegan, cowhide nappa look, 3-fold adjustable* | Similicuir, végétalien, aspect nappa bovin, 3 possibilités de réglage | *Cuero artificial, vegano, acabado napa de vaca, 3 posibilidades de ajuste* | Similpelle, vegana, effetto nappa di vacchetta, 3 possibilità di regolazione | *Kunstleder, vegansk, nappaoptik, 3-trins indstilling*

rot | red | rouge | rojo | rosso | rød

15/200 205201 20/200 205202

himbeer | raspberry | framboise | frambuesa | lampone | hindbær

15/200 205189 20/200 205190

braun | brown | marron | marrón | marrone | brun

15/200 205213 20/200 205214

schwarz | black | noir | negro | nero | sort

15/200 205225 20/200 205226



Snackbeutel SOFIA

Snack bag | Sac de récompense | Bolsa de recompensa | Borse per spuntini | Snack taske

Kunstleder, vegan, Rindnappa-Optik, mit Karabiner zum Einhängen an Gürtelschlaufe oder Tasche, ideal zur Aufbewahrung von Snacks, mit Hilfe eines Magnetverschlusses leicht zu öffnen | *faux leather, vegan, cowhide nappa look, with carabiner for hooking onto a belt loop or bag, ideal for storing snacks, easy to open with the help of a magnetic fastener* | Similicuir, végétalien, aspect nappa de bœuf, avec mousqueton pour accrocher à un passant de ceinture ou à un sac, idéal pour ranger des snacks, s'ouvre facilement à l'aide d'une fermeture magnétique | *Imitación de cuero, vegano, con aspecto de napa de vaca, con mosquetón para engancharlo a la trabilla del cinturón o al bolso, ideal para guardar aperitivos, fácil de abrir con ayuda de un cierre magnético* | Finta pelle, vegana, aspetto nappa di vacchetta, con moschettone per agganciarlo al passante della cintura o alla borsa, ideale per conservare gli snack, facile da aprire con l'aiuto di una chiusura magnetica | *Kunstleder, vegansk, koskind med nappa-look, med karabinhage til at hægte på en bæltestropp eller taske, ideel til opbevaring af snacks, nem at åbne ved hjælp af en magnetlukning*

rot | red | rouge | rojo | rosso | rød

205203

himbeer | raspberry | framboise | frambuesa | lampone | hindbær

205191

braun | brown | marron | marrón | marrone | brun

205215

schwarz | black | noir | negro | nero | sort

205227

■

16 x 13 cm





Halsung SOFTIE ALU-STRONG

Collar | Collier | Collar | Collare | Halsbånd

Kunstleder, Steckverschluss aus Aluminium, Metall-Schieber | *Artificial Leather, buckle made of aluminum, metal slide* | Similicuir, fermeture à clips pratique d'aluminium, coulisseau en métal | *Cuero artificial, cierre a presión de aluminio, pasador metálico* | Similpelle, chiusura a scatto in alluminio, fibbia di metallo | *Kunstleder, kliklås af aluminium, metalspændet*

rot | red | rouge | rojo | rosso | rød

M 60361 L 60362

XL 60363

himbeer | raspberry | framboise | frambuesa | lampone | hindbær

M 61749 L 61208

braun | brown | marron | marrón | marrone | brun

M 60365 L 60366

XL 60367

schwarz | black | noir | negro | nero | sort

M 60369 L 60370

XL 60371

⇒	↔	↔
M	30 – 45 cm	1,5 cm
L	40 – 55 cm	2,5 cm
XL	45 – 65 cm	2,5 cm



Halsband SOFTIE

Collar | Collier | Collar | Collare | Halsbånd

Kunstleder | *Artificial Leather* | Similicuir | *Cuero artificial* | Similpelle | *Kunstleder*

rot/schwarz | red/black | rouge/noir | rojo/negro | rosso/nero | rød/sort

40 47770 45 47771

50 47772 55 47773

60 47774 65 47775

himbeer/schwarz | raspberry/black | framboise/noir | frambuesa/negro | lampone/nero | hindbær/sort

40 61186 45 61187

50 61188 55 61189

60 61190

braun/schwarz | brown/black | marron/noir | marrón/negro | marrone/nero | brun/sort

40 47778 45 47779

50 47780 55 47781

60 47782 65 47783

schwarz | black | noir | negro | nero | sort

40 47549 45 47550

50 47551 55 47552

60 47553 65 47554

■	⇒	↔	↔
40	XS-S	28 – 34 cm	2,2 cm
45	S-M	32 – 40 cm	2,8 cm
50	S-M	36 – 44 cm	2,8 cm
55	M-L	42 – 50 cm	2,8 cm
60	M-L	46 – 53 cm	3,5 cm
65	L	51 – 58 cm	3,5 cm



MADE
IN
GERMANY



Size	Fit	Length	Width
45	S-M	32 – 40 cm	2,8 cm
50	S-M	36 – 44 cm	2,8 cm
55	M-L	42 – 50 cm	2,8 cm
60	M-L	46 – 53 cm	3,5 cm
65	L	51 – 58 cm	3,5 cm

Halsband SOFTIE STONE

Collar | Collier | Collar | Collare | Halsbånd

Kunstleder | Artificial Leather | Similicuir | Cuero artificial | Similpelle | Kunstleder

rot/schwarz | red/black | rouge/noir | rojo/negro | rosso/nero | rød/sort

45	47784	50	47785
55	47786	60	47787
65	47788		

braun/schwarz | brown/black | marron/noir | marrón/negro | marrone/nero | brun/sort

45	47789	50	47790
55	47791	60	47792
65	47793		

schwarz | black | noir | negro | nero | sort

45	47563	50	47564
55	47565	60	47566
65	47567		



MADE
IN
GERMANY



Size	Fit	Length	Width
35	XS	23 – 29 cm	2,2 cm
40	XS-S	28 – 34 cm	2,2 cm
45	S	33 – 39 cm	2,2 cm

Halsband SOFTIE DELUXE

Collar | Collier | Collar | Collare | Halsbånd

Kunstleder | Artificial Leather | Similicuir | Cuero artificial | Similpelle | Kunstleder

rot/schwarz | red/black | rouge/noir | rojo/negro | rosso/nero | rød/sort

35	47794	40	47795
45	47796		

braun/schwarz | brown/black | marron/noir | marrón/negro | marrone/nero | brun/sort

35	47797	40	47798
45	47799		

schwarz | black | noir | negro | nero | sort

35	47573	40	47574
45	47575		



MADE
IN
GERMANY



Size	Fit	Length	Width
50	S-M	37 – 43 cm	2,9 cm
55	M	42 – 48 cm	2,9 cm
60	M-L	46 – 52 cm	2,9 cm

Halsband SOFTIE TRILUXE

Collar | Collier | Collar | Collare | Halsbånd

Kunstleder | Artificial Leather | Similicuir | Cuero artificial | Similpelle | Kunstleder

rot/schwarz | red/black | rouge/noir | rojo/negro | rosso/nero | rød/sort

50	47800	55	47801
60	47802		

schwarz | black | noir | negro | nero | sort

50	47579	55	47580
60	47581		



Führleine SOFTIE

Leash | Laisse | Correa | Guinzaglio da passeggio | Line

Kunstleder | *Artificial Leather* | Similicuir | *Cuero artificial* | Similpelle | *Kunstleder*

rot/schwarz | red/black | rouge/noir | rojo/negro | rosso/nero | rød/sort

15/110 60235  20/100 60236 

himbeer/schwarz | raspberry/black | framboise/noir | frambuesa/negro | lampone/nero | hindbær/sort

15/110 61214  20/100 61215 

braun/schwarz | brown/black | marron/noir | marrón/negro | marrone/nero | brun/sort

15/110 60237  20/100 60238 

schwarz | black | noir | negro | nero | sort

15/110 60239  20/100 60240 



Verstellbare Führleine SOFTIE

Training leash | Laisse réglable | Correa ajustable | Guinzaglio da passeggio regolabile | Justerbar line

Kunstleder, 3-fache Verstellmöglichkeit | *Artificial Leather, 3-fold adjustable* | Similicuir, 3 possibilités de réglage | *Cuero artificial, 3 posibilidades de ajuste* | Similpelle, 3 possibilità di regolazione | *Kunstleder, 3-trins indstilling*

rot/schwarz | red/black | rouge/noir | rojo/negro | rosso/nero | rød/sort

15/200 47808  20/200 47809 

himbeer/schwarz | raspberry/black | framboise/noir | frambuesa/negro | lampone/nero | hindbær/sort

15/200 61216  20/200 61217 

braun/schwarz | brown/black | marron/noir | marrón/negro | marrone/nero | brun/sort

15/200 47810  20/200 47811 

schwarz | black | noir | negro | nero | sort

15/200 47587  20/200 47588 









Tau

— Rope —

Halsbänder und Leinen aus Tau sind für den trendbewussten Hundebesitzer ein Muss und aus der modischen Hundewelt nicht mehr wegzudenken. So überrascht es nicht, dass wir unser Sortiment an Tau-Artikeln stetig erweitern und von funktional und bunt, über maritim mit edlen Messingbeschlägen, bis hin zu aufwändig handgeflochtenen Tau-Variationen für jeden Geschmack etwas dabei haben.

Rope collars and leashes are a must for trend-conscious dog owners, and have become a fixture of dog fashion. So it is hardly surprising that we are constantly expanding our range of rope items, from functional and colourful to maritime-styled with refined brass fittings, or intricate hand-braided products, ensuring that we have something for every taste.

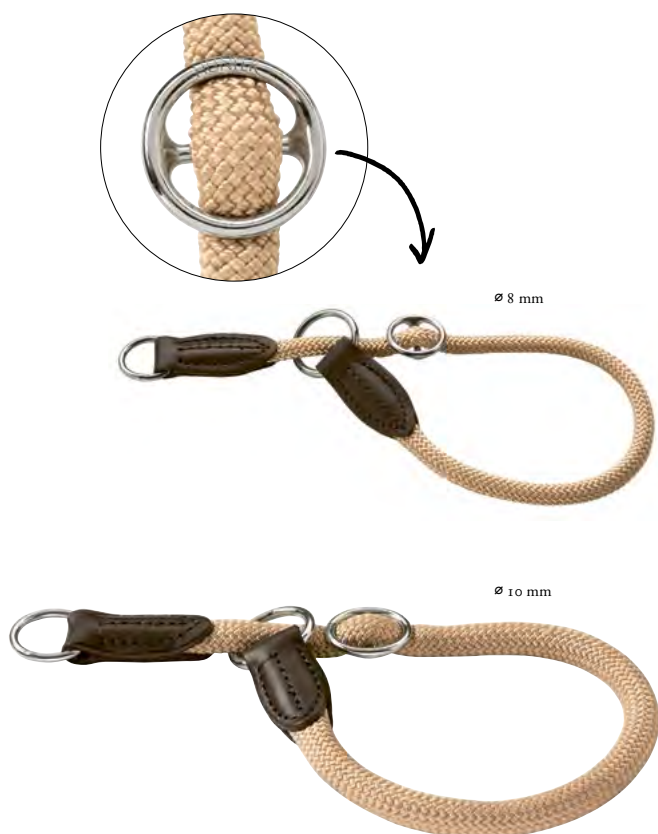

Dressurhalsung FREESTYLE & EIBY FREESTYLE

Training collar | Collier de dressage | Collar de adiestramiento | Collare da addestramento | Dressurhalsbånd

Tau, mit besonders stabilem Stoppring, stufenlos verstellbar | Rope, with a particularly durable stop ring, individually adjustable | Corde, avec bague d'arrêt particulièrement stable, réglable en continu | Cuerda, con anilla de retención especialmente estable, regulable en continuo | Corda, con anello di arresto particolarmente stabile, regolazione scorrevole | Tov, med meget stabil stopring, trinløs indstilling



für kleine Hunde
for small dogs
8 mm

	↔	↔	Ø
XS-S		max. 30 cm	8 mm
S		max. 35 cm	8 mm
S-M		max. 40 cm	8 mm

XL

M		max. 45 cm	10 mm
M-L		max. 50 cm	10 mm
L		max. 55 cm	10 mm
L-XL		max. 60 cm	10 mm
XL		max. 65 cm	10 mm

beige | tan | beige | beige | beige | beige

S	62601		S-M	62602	
M	46486		M-L	46487	
L	46488		L-XL	46489	

orange | orange | orange | naranja | arancione | orange

S	201872		S-M	201873	
M	201874		M-L	201875	
L	201876		L-XL	201877	

rot | red | rouge | rojo | rosso | rød

XS-S	62609		S	62610	
S-M	62611		M	40712	
M-L	39100		L	39101	
L-XL	39102		XL	67113	

bordeaux | bordeaux | bordeaux | burdeos | bordò | bordeaux

S	201888		S-M	201889	
M	201890		M-L	201891	
L	201892		L-XL	201893	



himbeer | raspberry | framboise | frambuesa | lampone | hindbær

S	62607		S-M	62608	
M	61523		M-L	61524	
L	61525		L-XL	61526	

Eiby blau | blue | bleu | azul | blu | blå

XS-S	68689		S	68690	
S-M	68691		M	68692	
M-L	68693		L	68694	
L-XL	68695				

petrol | teal | pétrole | petróleo | petrolio | petrol

S	62616		S-M	62617	
M	47857		M-L	47858	
L	47859		L-XL	47860	

dunkelgrün | dark green | vert foncé | verde oscuro | verde scuro | mørkegrøn

S	201904		S-M	201905	
M	201906		M-L	201907	
L	201908		L-XL	201909	

braun | brown | marron | marrón | marrone | brun

XS-S	62627		S	62628	
S-M	62629		M	43662	
M-L	43663		L	43664	
L-XL	43665		XL	67112	

Eiby grau | grey | gris | gris | grigio | grå

XS-S	68702		S	68703	
S-M	68704		M	68705	
M-L	68706		L	68707	
L-XL	68708				

grau | grey | gris | gris | grigio | grå

S	62631		S-M	62632	
M	46522		M-L	46523	
L	46524		L-XL	46525	

schwarz | black | noir | negro | nero | sort

XS-S	62633		S	62634	
S-M	62635		M	40718	
M-L	39110		L	39111	
L-XL	39112		XL	67111	



NEW colours



Führleine FREESTYLE & EIBY FREESTYLE

Leash | Laisse | Correa | Guinzaglio da passeggio | Line

Tau | Rope | Corde | Cuerda | Corda | Töv

beige | tan | beige | beige | beige | beige

8/110 46491 10/110 46492

orange | orange | orange | naranja | arancione | orange

8/110 201878 10/110 201879

rot | red | rouge | rojo | rosso | rød

8/110 32866 10/110 39105

bordeaux | bordeaux | bordeaux | burdeos | bordò | bordeaux

8/110 201894 10/110 201895

himbeer | raspberry | framboise | frambuesa | lampone | hindbær

8/110 61528 10/110 61527

Eiby blau | blue | bleu | azul | blu | blå

8/110 68697 10/110 68696

petrol | teal | pétrole | petróleo | petrolio | petrol

8/110 47861 10/110 47862

dunkelgrün | dark green | vert foncé | verde oscuro | verde scuro | mørkegrøn

8/110 201910 10/110 201911

braun | brown | marron | marrón | marrone | brun

8/110 43667 10/110 43668

grau | grey | gris | gris | grigio | grå

8/110 46527 10/110 46528

Eiby grau | grey | gris | gris | grigio | grå

8/110 68710 10/110 68709

schwarz | black | noir | negro | nero | sort

8/110 32868 10/110 39115

Führleine FREESTYLE EXTRA LONG

Leash | Laisse | Correa | Guinzaglio da passeggio | Line

Tau, besonders lange Führleine | Rope, extra-long leash | Corde, lanrière particulièrement longue | Cuerda, correa de paseo con largo especial | Corda, guinzagli particolarmente lunghi | Töv, særlig lang føresnor

schwarz | black | noir | negro | nero | sort

10/180 63004

XL
1,80 ml

Verstellbare Führleine FREESTYLE & EIBY FREESTYLE

Training leash | Laisse réglable | Correa ajustable | Guinzaglio da passeggio regolabile | Justerbar line

Tau, 3-fache Verstellmöglichkeit | *Rope, 3-fold adjustable* | Corde, 3 possibilités de réglage | *Cuerda, 3 posibilidades de ajuste* | Corda, 3 possibilità di regolazione | *Tov, 3-trins indstilling*



**NEW
colours**

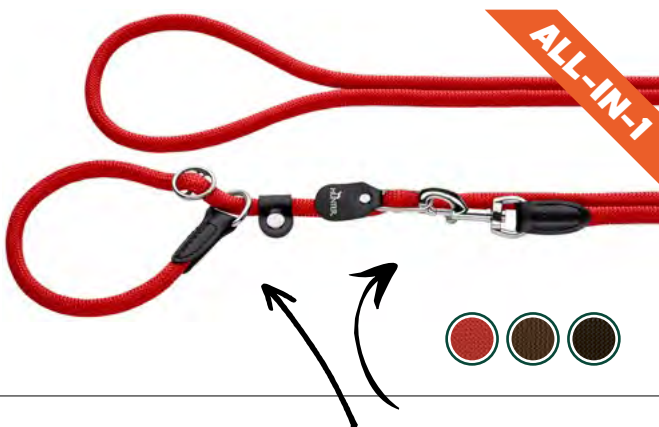

stufenlos verstellbar
individually adjustable

beige | tan | beige | beige | beige | beige

8/200 46493 10/200 46494

orange | orange | orange | naranja | arancione | orange

8/200 201880 10/200 201881

rot | red | rouge | rojo | rosso | rød

8/200 32876 10/200 39980

bordeaux | bordeaux | bordeaux | burdeos | bordò | bordeaux

8/200 201896 10/200 201897

himbeer | raspberry | framboise | frambuesa | lampone | hindbær

8/200 61538 10/200 61537

Eiby blau | blue | bleu | azul | blu | blå

8/200 68700 10/200 68701

petrol | teal | pétrole | petróleo | petrolio | petrol

8/200 47863 10/200 47864

dunkelgrün | dark green | vert foncé | verde oscuro | verde scuro | mørkegrøn

8/200 201912 10/200 201913

braun | brown | marron | marrón | marrone | brun

8/200 43669 10/200 43670

Eiby grau | grey | gris | gris | grigio | grå

8/200 68713 10/200 68714

grau | grey | gris | gris | grigio | grå

8/200 46529 10/200 46530

schwarz | black | noir | negro | nero | sort

8/200 32878 10/200 39981

Retriever-Führleine FREESTYLE

Retriever training leash | Laisse réglable pour retriever | Correa ajustable para retriever | Guinzaglio da passeggio retriever | Retrieverline

Tau, Halsung durch Stoppring und Schieber stufenlos verstellbar; Führleine mit Spezialschieber stufenlos verstellbar | *Rope, training collar individually adjustable with stopring and slide; training leash individually adjustable by special slide* | Corde, collier réglable en continu avec anneau d'arrêt et passant; laisse réglable en continu à l'aide d'un curseur spécial | *Cuerda, collar regulable mediante anilla y pasador; correa regulable mediante pasador especial* | Corda, collare a regolazione scorrevole tramite anello di arresto e regolatore; guinzaglio da passeggio a regolazione scorrevole tramite regolatore speciale | *Tov, trinløs indstilling af halsbånd via stopring og glider; med specialskydelukning på trinløs regulering*

rot | red | rouge | rojo | rosso | rød

10/260 39471

braun | brown | marron | marrón | marrone | brun

10/260 43678

schwarz | black | noir | negro | nero | sort

10/260 39472



Retriever-Leine FREESTYLE & EIBY FREESTYLE

Retriever leash | Laisse pour retriever | Correa para retriever | Guinzaglio retriever | Retrieverline

Tau, Halsung durch Stoppring und Schieber stufenlos verstellbar | Rope, training collar individually adjustable with stopring and slide | Corde, collier réglable en continu avec anneau d'arrêt et passant | Cuerda, collar regulable mediante anilla y pasador | Corda, collare a regolazione scorrevole tramite anello di arresto e regolatore | Tov, trinlos indstilling af halsbånd via stopring og glider

NEW colours



beige | tan | beige | beige | beige | beige

8/120 46498 8/170 46499

10/120 46500 10/170 46501

neongelb | neon yellow | jaune fluo | amarillo fosforescente | giallo fluo | neongul

10/170 61705

neonpink | neon pink | rose fluo | rosa fosforescente | rosa fluo | neonpink

10/170 61712

orange | orange | orange | naranja | arancione | orange

8/120 201882 8/170 201883

10/120 201884 10/170 201885

rot | red | rouge | rojo | rosso | rød

8/120 40768 8/170 32887

10/120 40772 10/170 39106

ALL-IN-1

bordeaux | bordeaux | bordeaux | burdeos | bordò | bordeaux

8/120 201898 8/170 201899

10/120 201900 10/170 201901

himbeer | raspberry | framboise | frambuesa | lampone | hindbær

8/120 61532 8/170 61533

10/120 61530 10/170 61531

Eiby blau | blue | bleu | azul | blu | blå

8/170 68699 10/170 68698

petrol | teal | pétrole | petróleo | petrolio | petrol

8/120 47868 8/170 47869

10/120 47870 10/170 47871

dunkelgrün | dark green | vert foncé | verde oscuro | verde scuro | mørkegrøn

8/120 201914 8/170 201915

10/120 201916 10/170 201917

braun | brown | marron | marrón | marrone | brun

8/120 43674 8/170 43675

10/120 43676 10/170 43677

Eiby grau | grey | gris | gris | grigio | grå

8/170 68712 10/170 68711

grau | grey | gris | gris | grigio | grå

8/120 46534 8/170 46535

10/120 46536 10/170 46537

schwarz | black | noir | negro | nero | sort

8/120 40770 8/170 32889

10/120 40774 10/170 39116



Vario-Leine FREESTYLE

Vario leash | Laisse Vario | Correa Vario |
Guinzaglio Vario | Vario line

Tau, durch Speziialschieber stufenlos verstellbar | *Rope, individually adjustable by special slide* | Corde, réglable en continu à l'aide d'un curseur spécial | *Cuerda, regulable en continuo mediante pasador especial* | Corda, regolazione scorrevole tramite regolatore speciale | *Tov, ed specialskeydelukning på trinløs indstilling*

NEW SIZE



**NEW
colours**

NEU
8mm, extra leicht
NEW 8 mm, extra light

beige | tan | beige | beige | beige | beige

10/200 46496

orange | orange | orange | naranja | arancione | orange

10/200 201886 10/260 201887

rot | red | rouge | rojo | rosso | rød

8/260 203338 10/200 39107

10/260 40727

bordeaux | bordeaux | bordeaux | burdeos | bordò | bordeaux

10/200 201902 10/260 201903

himbeer | raspberry | framboise | frambuesa | lamponne | hindbær

10/200 61534

petrol | teal | pétrole | petróleo | petrolio | petrol

10/200 47866

dunkelgrün | dark green | vert foncé | verde oscuro | verde scuro | mørkegrøn

8/260 203336 10/200 201918

10/260 201919

braun | brown | marron | marrón | marrone | brun

8/260 203339 10/200 43672

10/260 43673

grau | grey | gris | gris | grigio | grå

10/200 46532 10/260 46533

schwarz | black | noir | negro | nero | sort

8/260 203337 10/200 39117

10/260 40730

HANDMADE WITH LOVE



SONNE. SOMMER. MALIA.



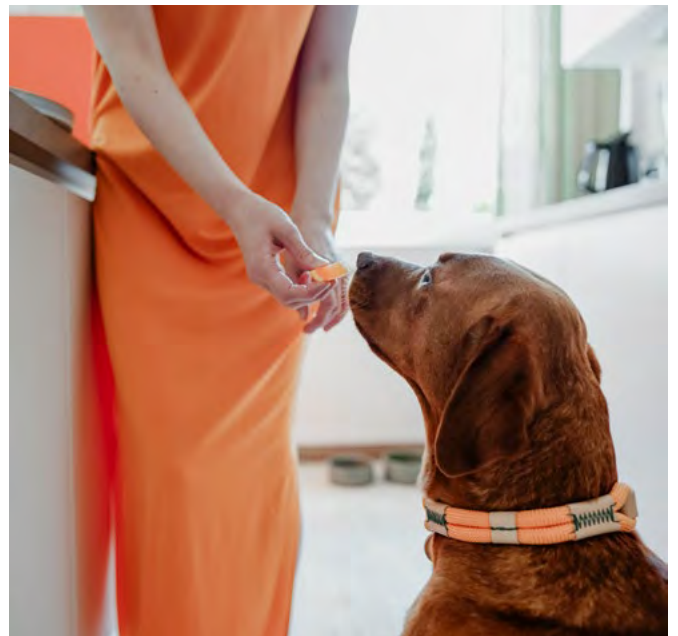
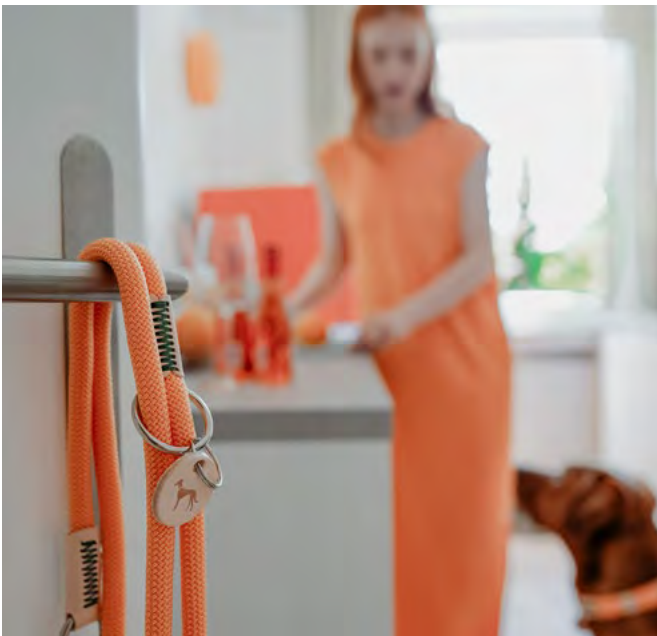



Halsband MALIA

Collar | Collier | Collar | Collare | Halsbånd

Tau/Rindsleder | Rope/Cow leather | Corde/Cuir de bœuf | Cuerda/Cuero de vacuno | Corda/Cuoio di bovina | Tov/Okselæder

beige | tan | beige | beige | beige | beige

40 207276  45 207277 

50 205021  55 205022 

60 205023  65 205024 

limette | lime | citron vert | limón | limetta | limone

40 207279  45 207280 

50 205026  55 205027 

60 205028  65 205029 

apricot | apricot | apricot | albaricoque | albicocca | abrikos

40 207282  45 207283 

50 205031  55 205032 

60 205033  65 205034 

taubenblau | dove blue | bleu pigeon | azul paloma | blu colomba | dueblå

40 207288  45 207289 

50 205041  55 205042 

60 205043  65 205044 

mint | mint | menthe | menta | menta | mynte

40 207285  45 207286 

50 205036  55 205037 

60 205038  65 205039 

brombeer | blackberry | mûre | mora | mora | brombær

40 207270  45 207271 

50 205061  55 205062 

60 205063  65 205064 

weinrot | wine red | rouge vin | rojo vino | vino rosso | vinrød

40 207264  45 207265 

50 205051  55 205052 

60 205053  65 205054 

dunkelblau | dark blue | bleu foncé | azul oscuro | blu scuro | mørkeblå

40 207267  45 207268 

50 205056  55 205057 

60 205058  65 205059 

dunkelgrün | dark green | vert foncé | verde oscuro | verde scuro | mørkegrøn

40 207273  45 207274 

50 205066  55 205067 

60 205068  65 205069 

schokobraun | chocolate brown | brun chocolat | marrón chocolate |

marrone cioccolato | chokoladebrun

40 207261  45 207262 

50 205046  55 205047 

60 205048  65 205049 

MADE
IN
GERMANY

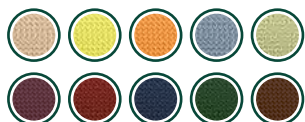

№	↕	↔	∅
40	S	30 – 35 cm	2 x 8 mm
45	S	35 – 40 cm	2 x 8 mm
50	S–M	35 – 44 cm	2 x 10 mm
55	M	40 – 49 cm	2 x 10 mm
60	M–L	45 – 54 cm	2 x 10 mm
65	L	50 – 59 cm	2 x 10 mm

für kleine Hunde
for small dogs

8 mm

FRÜHLINGS GEFÜHLE

**Aufregender Materialmix
aus Tau und Leder.**
*Exciting material mix of rope
and leather.*

Mit auffälligen Kontrastnähten.
With eye-catching contrast stitching.



**Alle Frühlingsfarben mit
silberfarbenen Metallbeschlagen.**
*All spring colours with
silver-coloured metal fittings.*

**Tau mit sehr
strapazierfähigem
Kern aus Polyamid.**
*Rope with a very
hard-wearing
polyamide core.*

**Passende Leinen mit smartem
Scherenkarabiner (bei 10 mm).**
*Matching leashes with smart
scissor carabiner (for 10 mm).*



**Alle Herbstfarben mit messing-
farbenen Metallbeschlagen.**
*All autumn colours with
brass-coloured metal fittings.*

GOLDENER HERBST

**Hergestellt in der HUNTER
Manufaktur in Bielefeld**
*Handmade in the HUNTER
manufactory in Bielefeld*



HANDMADE WITH LOVE • HANDMADE WITH LOVE •
♥

Es sind vor allem die kleinen Details im ausgeklügelten Design dieses Must-Haves, die für wahres Staunen und echte Begeisterung sorgen. Das außen weiche und anschmiegsame Tau mit einem sehr strapazierfähigem Polyamidkern wird von überaus schlichten und schönen Lederkappen mit frischer Kontrastnaht verbunden.

It is above all the small details in the sophisticated design of this must-have that cause true amazement and genuine enthusiasm. The soft and supple rope on the outside with a very hard-wearing polyamide core is combined with extremely simple and attractive leather caps with fresh contrast stitching.





MADE
IN 
GERMANY



Ø 8 MM



Ø 10 MM

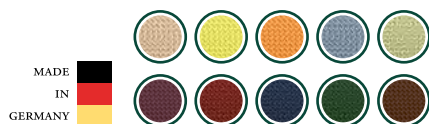

Verstellbare Führleine MALIA

Training leash | Laisse réglable | Correa ajustable | Guinzaglio da passeggio regolabile | Justerbar line

Tau/Rindsleder, 3-fache Verstellmöglichkeit | Ropel/Cow leather, 3-fold adjustable | Corde/Cuir de bœuf, 3 possibilités de réglage | Cuerda/Cuero de vacuno, 3 posibilidades de ajuste | Corda/Cuoio di bovina, 3 possibilità di regolazione | Tov/Okselæder, 3-trins indstilling

beige | tan | beige | beige | beige | beige

8/200 207278 10/200 205025

limette | lime | citron vert | limón | limetta | limone

8/200 207281 10/200 205030

apricot | apricot | apricot | albaricoque | albicocca | abrikos

8/200 207284 10/200 205035

taubenblau | dove blue | bleu pigeon | azul paloma | blu colomba | dueblå

8/200 207290 10/200 205045

mint | mint | menthe | menta | menta | mynte

8/200 207287 10/200 205040

brombeer | blackberry | mûre | mora | mora | brombær

8/200 207272 10/200 205065

weinrot | wine red | rouge vin | rojo vino | vino rosso | vinrød

8/200 207266 10/200 205055

dunkelblau | dark blue | bleu foncé | azul oscuro | blu scuro | mørkeblå

8/200 207269 10/200 205060

dunkelgrün | dark green | vert foncé | verde oscuro | verde scuro | mørkegrøn

8/200 207275 10/200 205070

schokobraun | chocolate brown | brun chocolat | marrón chocolate |

marrone cioccolato | chokoladebrun

8/200 207263 10/200 205050

Mit smartem Scherenkarabiner (bei 10 mm).

With smart scissor carabiner (for 10 mm).



Alle Frühlingfarben mit silberfarbenen Metallbeschlägen.

All spring colours with silver-coloured metal fittings.



Alle Herbstfarben mit messingfarbenen Metallbeschlägen.

All autumn colours with brass-coloured metal fittings.



MESSING
Brass



⇒	↔*	∅
M-L	50 cm	2 x 10 mm
L	55 cm	2 x 10 mm

Halsung SANSIBAR RANTUM

Collar | Collier | Collar | Collare | Halsbånd

Tau, Messingbeschläge, modernes, nautisch angehauchtes Design, auffällige Farbakzente | *Rope, brass fittings, modern, nautically-inspired design, striking colour accents* | Corde, garnitures en laiton, design moderne d'inspiration nautique, notes de couleurs voyantes | *Cuerda, adornos de latón, diseño moderno y de estilo náutico, toques de color llamativos* | Corda, guarnizioni in ottone, design moderno e in stile nautico, tocchi cromatici vistosi | *Tov, Messingbeslag, moderne, maritimt design, iøjnefaldende farver*

beige | tan | beige | beige | beige | beige

M-L 65642 L 65643

grau | grey | gris | gris | grigio | grå

M-L 65647 L 65648



MESSING
Brass



Verstellbare Führleine

SANSIBAR RANTUM

Training leash | Laisse réglable | Correa ajustable | Guinzaglio da passeggio regolabile | Justerbar line

Tau, Messingbeschläge, individuelle Verstellmöglichkeit (Ringe sind in Knoten befestigt, die auf der Leine verschoben werden können), modernes, nautisch angehauchtes Design, auffällige Farbakzente | *Rope, brass fittings, individually adjustable (rings are secured with knots that can be slid up the leash), modern nautically-inspired design, striking colours accents* | Corde, garnitures en laiton, possibilité de réglage individuel (les anneaux sont attachés par des noeuds qui peuvent être déplacés le long de la laisse), design moderne d'inspiration nautique, notes de couleurs voyantes | *Cuerda, adornos de latón, posibilidad de ajuste individual (los anillos están sujetos con nudos que se pueden desplazar por la correa), diseño moderno y de estilo náutico, toques de color llamativos* | Corda, guarnizioni in ottone, regolazione personalizzabile (gli anelli sono fissati nei nodi che possono essere spostati sul guinzaglio), design moderno e in stile nautico, tocchi cromatici vistosi | *Tov, Messingbeslag, kan justeres individuelt (ringe er fastgjort i knuder, som kan forskydes på linen), moderne, maritimt design, iøjnefaldende farver*

beige | tan | beige | beige | beige | beige

10/200 65646

grau | grey | gris | gris | grigio | grå

10/200 65651



MADE
IN
GERMANY

Size	Label	Length (cm)	Width (cm)
45	S	33 – 39	3
50	S-M	38 – 44	3
55	M	43 – 49	3

Halsband TRINO

Collar | Collier | Collar | Collare | Halsbånd

Rindsleder/Baumwolle | Cow leather/Cotton | Cuir de boeuf/Coton | Cuero de vacuno/Algodón | Cuoio di bovina/Cotone | Okselæder/Bomuld
 grau/natur | grey/nature | gris/nature | gris/natural | grigio/naturale | grå/natur

45 69342 50 69343
 55 69344



besonders
LANG & BREIT
extra long & wide

MADE
IN
GERMANY

Führleine TRINO

Leash | Laisse | Correa | Guinzaglio da passeggio | Line

Rindsleder/Baumwolle | Cow leather/Cotton | Cuir de boeuf/Coton | Cuero de vacuno/Algodón | Cuoio di bovina/Cotone | Okselæder/Bomuld
 grau/natur | grey/nature | gris/nature | gris/natural | grigio/naturale | grå/natur

30/120 69345

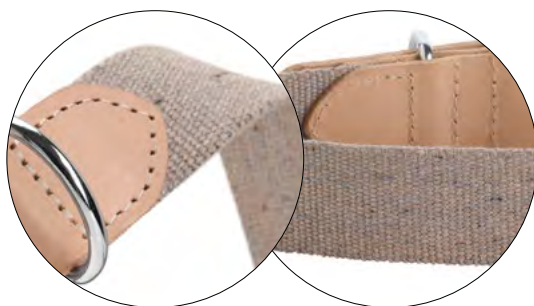

Grandioser Material-Mix

Wenn puristisches Design auf einen haptisch spannenden Materialmix trifft, entsteht dieses Halsband im Scandi-Boho-Stil. Die aufregende Kombination robusten, naturbelassenen Rindsleders mit einem dezent in sich gemusterten Baumwollgurt bildet eine geradewegs perfekte Symbiose.

Grandiose material mix. When purist design meets a haptically exciting mix of materials, the result is this Scandi-Boho style collar. The exciting combination of robust, natural cowhide with a discreetly patterned cotton strap creates a perfect symbiosis.





nr	⇒	↔	↔
35	XS-S	23 – 31 cm	2,0 cm
40	S	28 – 36 cm	2,0 cm
45	S-M	33 – 41 cm	2,0 cm
50	M	38 – 46 cm	2,5 cm
55	M-L	42 – 50 cm	2,5 cm
60	L	47 – 55 cm	2,5 cm
65	L-XL	53 – 61 cm	2,5 cm

Aus einem innovativen, starken Kunststoffgemisch gibt es bei HUNTER verschiedene Halsbänder mit passender Leine, sowie Suchleinen für das Üben und Arbeiten mit dem Hund in Neon- und klassischen Farben. Das wasser-, und besonders reißfeste Material lässt sich zudem einfach reinigen und bietet optimale Sichtbarkeit bei jedem Wetter und auf allen Untergründen.

HUNTER presents various collars and matching leashes, in neon and classic colours, made from an innovative, strong plastic mixture, as well as search lines for training and working with the dog. In addition, the water and tear-resistant material is easy to clean and is clearly visible in all weather conditions and on all surfaces.

Halsband CONVENIENCE

Collar | Collier | Collar | Collare | Halsbånd

reißfestes, pflegeleichtes Material | *tear-resistant, easy-care material* | matériau résistant à la déchirure et facile d'entretien | *material resistente y fácil de limpiar* | resistente agli strappi, materiale facile da pulire | *trækstærkt, plejelet materiale*

neongelb | neon yellow | jaune fluo | amarillo fosforescente | giallo fluo | neongul

35	63124		40	63130	
45	63136		50	63142	
55	63148		60	63154	
65	63160				

neonorange | neon orange | orange fluo | naranja fosforescente | arancione fluo | neonorange

35	63125		40	63131	
45	63137		50	63143	
55	63149		60	63155	
65	63161				

neonpink | neon pink | rose fluo | rosa fosforescente | rosa fluo | neonpink

35	63126		40	63132	
45	63138		50	63144	
55	63150		60	63156	
65	63162				

himbeer | raspberry | framboise | frambuesa | lamponne | hindbær

35	68901		40	68902	
45	68903		50	68904	
55	68905		60	68906	
65	68907				

türkis | turquoise | turquoise | turquesa | turchese | turkis

35	63129		40	63135	
45	63141		50	63147	
55	63153		60	63159	
65	63165				

apfelgrün | apple green | pomme verte | verde manzana | verde mela | æblegrøn

35	68919		40	68920	
45	68921		50	68922	
55	68923		60	68924	
65	68925				

schwarz | black | noir | negro | nero | sort

35	63127		40	63133	
45	63139		50	63145	
55	63151		60	63157	
65	63163				



mit weicher
POLSTERUNG
with soft lining

nr	⇒	↔	↔
35	XS-S	22 – 30 cm	2,0 cm
40	S	27 – 35 cm	2,0 cm
45	S-M	32 – 40 cm	2,0 cm
50	M	37 – 45 cm	2,5 cm
55	M-L	42 – 50 cm	2,5 cm
60	L	47 – 55 cm	2,5 cm
65	L-XL	52 – 60 cm	2,5 cm



Halsband CONVENIENCE COMFORT

Collar | Collier | Collar | Collare | Halsbånd

reißfestes, pflegeleichtes Material, mit Neopren gepolstert | *tear-resistant, easy-care material, padded with neoprene* | matériau résistant à la déchirure et facile d'entretien, doublée avec du néoprène | *material resistente y fácil de limpiar, recubierta con neopreno* | resistente agli strappi, materiale facile da pulire, imbottito con neoprene | *træksterkt, plejelet materiale, med neopren-polstring*

neongelb | neon yellow | jaune fluo | amarillo fosforescente | giallo fluo | neongul

35	63082		40	63088	
45	63094		50	63100	
55	63106		60	63112	
65	63118				

neonorange | neon orange | orange fluo | naranja fosforescente | arancione fluo | neonorange

35	63083		40	63202	
45	63095		50	63101	
55	63107		60	63113	
65	63119				

neonpink | neon pink | rose fluo | rosa fosforescente | rosa fluo | neonpink

35	63084		40	63090	
45	63096		50	63102	
55	63108		60	63114	

himbeer | raspberry | framboise | frambuesa | lamponne | hindbær

35	68908		40	68909	
45	68910		50	68911	
55	68912		60	68913	
65	68914				

türkis | turquoise | turquoise | turquesa | turchese | turkis

35	63087		40	63093	
45	63099		50	63105	
55	63111		60	63117	
65	63123				

apfelgrün | apple green | pomme verte | verde manzana | verde mela | æblegrøn

35	68926		40	68927	
45	68928		50	68929	
55	68930		60	68931	
65	68932				

schwarz | black | noir | negro | nero | sort

35	63085		40	63091	
45	63097		50	63103	
55	63109		60	63115	
65	63121				



Führleine CONVENIENCE

Leash | Laisse | Correa | Guinzaglio da passeggio | Line

reißfestes, pflegeleichtes Material, mit Neopren gepolsterte Hand-
schlaufe | *tear-resistant, easy-care material, with neoprene-padded palm
rest* | matériau résistant à la déchirure et facile d'entretien, avec repo-
se-main rembourré en néoprène | *material resistente y fácil de limpiar,
con agarre acolchado de neopreno* | resistente agli strappi, materiale facile
da pulire, con impugnatura imbottita in neoprene | *træksterkt, plejelet
materiale, med neopren polstret håndpåleg*

mit weicher
POLSTERUNG
with soft lining

neongelb | neon yellow | jaune fluo | amarillo fosforescente | giallo fluo |
neongul

15/120 63070 20/120 63077

neonorange | neon orange | orange fluo | naranja fosforescente | arancione
fluo | neonorange

15/120 63071 20/120 63078

neonpink | neon pink | rose fluo | rosa fosforescente | rosa fluo | neonpink

15/120 63072 20/120 63079

himbeer | raspberry | framboise | frambuesa | lampone | hindbær

15/120 68915 20/120 68916

türkis | turquoise | turquoise | turquesa | turchese | turkis

15/120 63075 20/120 63076

apfelgrün | apple green | pomme verte | verde manzana | verde mela |
æblegrøn

15/120 68933 20/120 68934

schwarz | black | noir | negro | nero | sort

15/120 63073 20/120 63080



Verstellbare FÜHRLEINE CONVENIENCE

Training leash | Laisse réglable | Correa ajustable | Guinzaglio da
passeggio regolabile | Justerbar line

reißfestes, pflegeleichtes Material, 3-fache Verstellmöglichkeit |
tear-resistant, easy-care material, 3-fold adjustable | matériau résistant
à la déchirure et facile d'entretien, 3 possibilités de réglage | *material
resistente y fácil de limpiar, 3 posibilidades de ajuste* | resistente agli strap-
pi, materiale facile da pulire, 3 possibilità di regolazione | *træksterkt,
plejelet materiale, 3-trins indstilling*

neongelb | neon yellow | jaune fluo | amarillo fosforescente | giallo fluo |
neongul

15/200 63167 20/200 63173

neonorange | neon orange | orange fluo | naranja fosforescente | arancione
fluo | neonorange

15/200 63166 20/200 63172

neonpink | neon pink | rose fluo | rosa fosforescente | rosa fluo | neonpink

15/200 63168 20/200 63174

himbeer | raspberry | framboise | frambuesa | lampone | hindbær

15/200 68917 20/200 68918

türkis | turquoise | turquoise | turquesa | turchese | turkis

15/200 63171 20/200 63177

apfelgrün | apple green | pomme verte | verde manzana | verde mela |
æblegrøn

15/200 68935 20/200 68936

schwarz | black | noir | negro | nero | sort

15/200 63170 20/200 63176

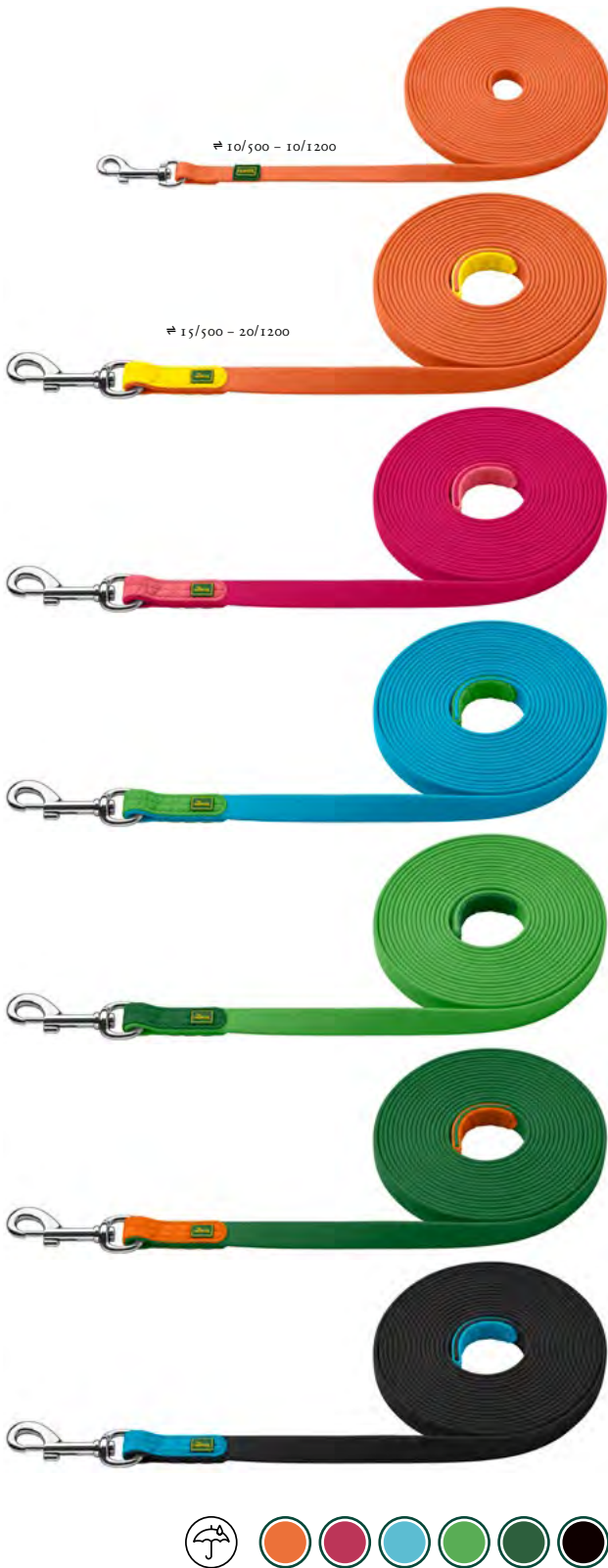

Suchleine CONVENIENCE

Tracking leash | Laisse de promenade | Correa de rastreo | Guinzaglio da ricerca | Sogeline

reißfestes, pflegeleichtes Material, besonders geeignet zum Einsatz bei der Jagd und im Hundesport (z.B. Mantrailing), ohne Handschlaufe | *tear-resistant, easy-care materials, especially suitable for use in hunting and dog sports (e.g. mantrailing), without wrist strap* | matériau résistant à la déchirure et facile d'entretien, convient particulièrement pour les activités de chasse et les sports (le mantrailing, par exemple), sans dragonne | *material resistente y fácil de limpiar, especialmente adecuado para su utilización durante la caza o en deportes caninos (p. ej. en mantrailing), sin correa para la mano* | resistente agli strappi, materiale facile da pulire, particolarmente adatto per l'uso nella caccia e negli sport per cani (ad es. mantrailing), senza cinghia | *træksterkt, plejelet materiale, særlig egnet til indsats ved jagt og i hundesport (f.eks. mantrailing), uden håndstrop*

neonorange | neon orange | orange fluo | naranja fosforescente | arancione fluo | neonorange

10/500 69872  10/1200 69875 

15/500 69873  15/1200 69876 

20/500 69874  20/1200 69877 

himbeer | raspberry | framboise | frambuesa | lampone | hindbær

10/500 69866  10/1200 69869 

15/500 69867  15/1200 69870 

20/500 69868  20/1200 69871 

türkis | turquoise | turquoise | turquesa | turchese | turkis

10/500 69884  10/1200 69887 

15/500 69885  15/1200 69888 

20/500 69886  20/1200 69889 

apfelgrün | apple green | pomme verte | verde manzana | verde mela | æblegrøn

10/500 69860  10/1200 69863 

15/500 69861  15/1200 69864 

20/500 69862  20/1200 69865 

dunkelgrün | dark green | vert foncé | verde oscuro | verde scuro | mørkegrøn

10/500 69890  10/1200 69893 

15/500 69891  15/1200 69894 

20/500 69892  20/1200 69895 

schwarz | black | noir | negro | nero | sort

10/500 69878  10/1200 69881 

15/500 69879  15/1200 69882 

20/500 69880  20/1200 69883 

Langlebig, reißfest und witterungsbeständige sowie griffig bei Wärme und Kälte gleichermaßen ist unsere Schleppeine der ideale Begleiter für alle Wetterbedingungen und bietet maximalen Komfort und Sicherheit.

Durable, tear-resistant and weatherproof as well as grippy in warmth and cold alike, our drag leash is the ideal companion for all weather conditions and offers maximum comfort and safety.



Halsband CONVENIENCE REFLECT

Collar | Collier | Collar | Collare | Halsbånd

reißfestes, pflegeleichtes Material, reflektierend | *tear-resistant, easy-care material, reflective* | matériau résistant à la déchirure et facile d'entretien, réfléchissant | *material resistente y fácil de limpiar, reflectante* | resistente agli strappi, materiale facile da pulire, riflettente | *træksterkt, plejelet materiale, reflekterende*

Sterne | Stars | Stars | Estrellas | Stelle | Stjerner

35 69126 40 69127

45 69128 50 69129

55 69130 60 69131

65 69132

Leopard | Leopard | Léopard | Leopardo | Leopardo | Leopard

35 69137 40 69138

45 69139 50 69140

55 69141 60 69142

65 69143

		■	⇒	↔	↔
		35	XS-S	23 – 31 cm	2,0 cm
		40	S	28 – 36 cm	2,0 cm
		45	S-M	33 – 41 cm	2,0 cm
		50	M	38 – 46 cm	2,5 cm
		55	M-L	42 – 50 cm	2,5 cm
		60	L	47 – 55 cm	2,5 cm
		65	L-XL	53 – 61 cm	2,5 cm



Führleine CONVENIENCE REFLECT

Leash | Laisse | Correa ajustable | Guinzaglio da passeggio regolabile | Justerbar line

reißfestes, pflegeleichtes Material, mit Neopren gepolsterte Hand-schleife | *tear-resistant, easy-care material, with neoprene-padded palm rest, reflective* | matériau résistant à la déchirure et facile d'entretien, avec repose-main rembourré en néoprène, réfléchissant | *material resistente y fácil de limpiar, con agarre acolchado de neopreno, reflectante* | resistente agli strappi, materiale facile da pulire, con impugnatura imbottita in neoprene, riflettente | *træksterkt, plejelet materiale, med neopren polstret håndpålæg, reflekterende*

Sterne | Stars | Stars | Estrellas | Stelle | Stjerner

20/120 69134

Leopard | Leopard | Léopard | Leopardo | Leopardo | Leopard

20/120 69145



Verstellbare Führleine CONVENIENCE REFLECT

Training leash | Laisse réglable | Correa ajustable | Guinzaglio da passeggio regolabile | Justerbar line

reißfestes, pflegeleichtes Material, 3-fache Verstellmöglichkeit, reflektierend | *tear-resistant, easy-care material, 3-fold adjustable, reflective* | matériau résistant à la déchirure et facile d'entretien, 3 possibilités de réglage, réfléchissant | *material resistente y fácil de limpiar, 3 posibilidades de ajuste, reflectante* | resistente agli strappi, materiale facile da pulire, 3 possibilità di regolazione, riflettente | *træksterkt, plejelet materiale, 3-trins indstilling, reflekterende*

Sterne | Stars | Stars | Estrellas | Stelle | Stjerner

15/200 69135 20/200 69136

Leopard | Leopard | Léopard | Leopardo | Leopardo | Leopard

15/200 69146 20/200 69147





Size	Neck	Length	Width
35	XS-S	23 – 31 cm	2,0 cm
40	S	28 – 36 cm	2,0 cm
45	S-M	33 – 41 cm	2,0 cm
50	M	38 – 46 cm	2,5 cm
55	M-L	42 – 50 cm	2,5 cm
60	L	47 – 55 cm	2,5 cm
65	L-XL	53 – 61 cm	2,5 cm

Halsband CONVENIENCE REFLECT GLOW

Collar | Collier | Collar | Collare | Halsbånd

reißfestes, pflegeleichtes Material, reflektierend, fluoreszierend | *tear-resistant, easy-care material, reflective, fluorescent* | matériau résistant à la déchirure et facile d'entretien, réfléchissant, fluorescent | *material resistente y fácil de limpiar, reflectante, fluorescente* | resistente agli strappi, materiale facile da pulire, riflettente, fluorescente | *træksterkt, plejelet materiale, reflekterende, fluorescerende*

Sterne | Stars | Stars | Estrellas | Stelle | Stjerner

35	69148		40	69149	
45	69150		50	69151	
55	69152		60	69153	
65	69154				

Leopard | Leopard | Léopard | Leopardo | Leopardo | Leopard

35	69159		40	69160	
45	69161		50	69162	
60	69164		65	69165	



Führleine CONVENIENCE REFLECT GLOW

Leash | Laisse | Correa | Guinzaglio da passeggio | Line

reißfestes, pflegeleichtes Material, mit Neopren gepolsterte Hand-schleufe, reflektierend, fluoreszierend | *tear-resistant, easy-care material, with neoprene-padded palm rest, reflective, fluorescent* | matériau résistant à la déchirure et facile d'entretien, avec repose-main rembourré en néoprène, réfléchissant, fluorescent | *material resistente y fácil de limpiar, con agarre acolchado de neopreno, reflectante, fluorescente* | resistente agli strappi, materiale facile da pulire, con impugnatura imbottita in neoprene, riflettente, fluorescente | *træksterkt, plejelet materiale, med neopren polstret håndpålæg, reflekterende, fluorescerende*

Sterne | Stars | Stars | Estrellas | Stelle | Stjerner

20/120 69156

Leopard | Leopard | Léopard | Leopardo | Leopardo | Leopard

20/120 69167



Verstellbare Führleine CONVENIENCE REFLECT GLOW

Training leash | Laisse réglable | Correa ajustable | Guinzaglio da passeggio regolabile | Justerbar line

reißfestes, pflegeleichtes Material, 3-fache Verstellmöglichkeit, reflektierend, fluoreszierend | *tear-resistant, easy-care material, 3-fold adjustable, reflective, fluorescent* | matériau résistant à la déchirure et facile d'entretien, 3 possibilités de réglage, réfléchissant, fluorescent | *material resistente y fácil de limpiar, 3 posibilidades de ajuste, reflectante, fluorescente* | resistente agli strappi, materiale facile da pulire, 3 possibilità di regolazione, riflettente, fluorescente | *træksterkt, plejelet materiale, 3-trins indstilling, reflekterende, fluorescerende*

Sterne | Stars | Stars | Estrellas | Stelle | Stjerner

15/200 69157

20/200 69158

Leopard | Leopard | Léopard | Leopardo | Leopardo | Leopard

15/200 69168

20/200 69169



Nylon

Das umfangreiche Nylon-Angebot von HUNTER wird aus hochwertigem Polyamidgurt hergestellt. Dieser Gurt ist nicht nur äußerst strapazierfähig, extrem reißfest und belastbar, sondern auch vielseitig einsetzbar. Egal ob flach oder rund gewebt, als Halsband, Geschirr oder Leine, pur oder mit hochwertigem Leder oder wetterfestem Neopren unterlegt – unser Nylon-Sortiment ist mit seiner bunten Farbpalette ein Multitalent in Sachen Style.

The varied nylon Range by HUNTER is manufactured using high-quality polyamide fibre. This fibre is not only exceedingly hardwearing, extremely resistant to tearing and reliable, it can also be used in many different ways. No matter whether it is woven flat or round, as a collar, a harness or a leash, on its own or accompanied with high-quality leather or weatherproof neoprene, our colourful assortment of nylon products scores top marks when it comes to style.



Alles im
GRIFF

Everything under control



MALDON

Komfort, Funktion & Design

Comfort, function & design

Großartige Passform, weich gepolstert, extrem komfortabel. Die Serie MALDON ist ein echtes Muss für alle Hundehalter, die einen praktischen Allrounder für alle Gelegenheiten für ihren vierbeinigen Liebling suchen.

Great fit, softly padded, extremely comfortable. The MALDON range is a real must-have for all dog owners who are looking for a practical all-rounder for all occasions for their four-legged friend.

ZUG-
ENTLASTUNG
with pull-relief



Halsung MALDON

Collar | Collier | Collar | Collare | Halsbånd

Polyester, stufenlos verstellbar, mit Zugentlastung, hohe Zugfestigkeit, extrem belastbare, lautlose und leichte Ringschleufe, rostfrei, allergikerfreundlich, kratzfrei und ohne Schweißpunkte, Adresslabel im Innern der Halsung, weich gepolstert, gute Passform | *Polyester, infinitely adjustable, with pull relief, high tensile strength, extremely durable, silent and lightweight ring loop, rust-free, allergy-friendly, scratch-free and without welding points, address label inside the collar, softly padded, good fit* | Polyester, réglable en continu, avec décharge de traction, haute résistance à la traction, boucle d'anneau extrêmement résistante, silencieuse et légère, inoxydable, hypoallergénique, sans rayures et sans points de soudure, étiquette d'adresse à l'intérieur du collier, rembourré en douceur, bonne coupe | *Poliéster, infinitamente ajustable, con alivio de tensión, alta resistencia a la tracción, extremadamente duradero, bucle de anilla silencioso y ligero, sin óxido, antialérgico, sin arañazos y sin puntos de soldadura, etiqueta de dirección en el interior del collar, suavemente acolchado, buen ajuste* | Poliestere, regolabile in continuo, con scarico della trazione, alta resistenza alla trazione, estremamente durevole, passante ad anello silenzioso e leggero, senza ruggine, anallergico, senza graffi e senza punti di saldatura, etichetta con indirizzo all'interno del collare, morbidamente imbottito, buona vestibilità | *Polyester, trinløst justerbar, med trækafastning, høj trækstyrke, ekstremt holdbar, lydsvag og let ringstrop, rustfri, allergivenlig, ridsefri og uden svejsepunkter, adresselabel inden i kraven, blødt polstret, god pasform*



orange/grau | orange/grey | orange/gris | naranja/gris | arancione/grigio | orange/grå

S 205334 M 205337

L 205340 XL 205343

rot/grau | red/grey | rouge/gris | rojo/gris | rosso/grigio | rød/grå

S 205310 M 205313

L 205316 XL 205319

altrosa/grau | old pink/grey | vieux rose/gris | rosa viejo/gris | rosa antico/grigio | gammel pink/grå

S 205394 M 205397

L 205400 XL 205403

petrol/grau | teal/grey | pétrole/gris | petróleo/gris | petrolio/grigio | petrol/grå

S 205322 M 205325

L 205328 XL 205331

blau/grau | blue/grey | bleu/gris | azul/gris | blu/grigio | blå/grå

S 205382 M 205385

L 205388 XL 205391

⇒	↔	↔
S	25 – 35 cm	1,5 cm
M	35 – 45 cm	2,0 cm
L	45 – 55 cm	2,5 cm
XL	55 – 65 cm	2,5 cm



LAUTLOSE HALSUNG

Silent collar



Extrem robust
Extremely durable



oliv/grau | olive/grey | olive/gris | oliva/gris | oliva/grigio | olivenfarvet/grå

S 205346  M 205349 

L 205352  XL 205355 

dunkelgrün/grau | dark green/grey | vert foncé/gris | verde oscuro/gris | verde scuro/grigio | mørkegrøn/grå

S 205370  M 205373 

L 205376  XL 205379 

braun/grau | brown/grey | marron/gris | marrón/gris | marrone/grigio | brun/grå

S 205298  M 205301 

L 205304  XL 205307 

hellgrau/grau | light grey/grey | gris clair/gris | gris claro/gris | grigio chiaro/grigio | lysegrå/grå

S 205358  M 205361 

L 205364  XL 205367 

schwarz/grau | black/grey | noir/gris | negro/gris | nero/grigio | sort/grå

S 205286  M 205289 

L 205292  XL 205295 

-  **Lautlose und leichte Ringschlaufe**
Silent and lightweight ring loop
-  **Hohe Zugfestigkeit**
High tensile strength
-  **Rostfrei, kratzfrei und ohne Schweißpunkte**
Rust-free, scratch-free and without welding points
-  **Adresslabel im Innern der Halsung**
Address label inside the collar
-  **Weich gepolstert**
Softly padded
-  **Stufenlos verstellbar**
Infinitely adjustable
-  **Mit Zugentlastung**
With pull relief
-  **Allergikerfreundlich**
Allergy-friendly

PerfectFIT

Soft-Polsterung
Soft padding

4-fach verstellbar
4-fold adjustable

3M | **Scotchlite**
Reflective Material

Stark reflektierend durch
3M™ Scotchlite™ Reflective Material
*Highly reflective thanks to
3M™ Scotchlite™ Reflective Material*

**NEW
feature**

Mit gepolstertem Griff (ab Gr. S-M)
With padded handle (from size S-M)



Verschlüsse unterpolstert
Closures padded



Mit besonders langem
Unterbruststeg
With extended chest strap



**Griff ermöglicht schnelle,
direkte Kontrolle**

Handle enables quick, direct control





Geschirr MALDON UP

Harness | Harnais | Arnés | Pettorina | Sele

Polyester, 4-fache Verstellmöglichkeit, mit gepolsterem Griff (ab Gr. S-M), durch 3M™ Scotchlite™ Reflective Material stark reflektierend, weich gepolstert, gute Passform | Polyester, 4-fold adjustable, with padded handle (from size S-M), highly reflective with 3M™ Scotchlite™ Reflective Material, soft padding, good fit | Polyester, 4 possibilités de réglage, avec poignée rembourrée (à partir de la taille S-M), est très réfléchissant grâce à des éléments 3M™ Scotchlite™ Reflective Material, rembourrage doux, bon ajustement | Poliéster, 4 posibilidades de ajuste, con asa acolchada (a partir de la talla S-M), es altamente reflectante gracias a los elementos 3M™ Scotchlite™ Reflective Material, acolchado suave, ajuste perfecto | Poliestere, 4 possibilità di regolazione, con maniglia imbottita (dalla taglia S-M), è altamente catarinfrangente grazie agli elementi 3M™ Scotchlite™ Reflective Material, morbida imbottitura, buona vestibilità | Polyester, 4-trins indstilling, med polstret håndtag (fra størrelse S-M), stærkt reflekterende 3M™ Scotchlite™ Reflective Material elementer, blød polstring, god pasform

orange/grau | orange/grey | orange/gris | naranja/gris | arancione/grigio | orange/grå

XS	201842		XS-S	201843	
S-M	201844		M	201845	
M-L	201846		L	201847	

rot/grau | red/grey | rouge/gris | rojo/gris | rosso/grigio | rød/grå

XS	201824		XS-S	201825	
S-M	201826		M	201827	
M-L	201828		L	201829	

altrosa/grau | old pink/grey | vieux rose/gris | rosa viejo/gris | rosa antico/grigio | gammel pink/grå

XS	69781		XS-S	69782	
S-M	69783		M	69784	
M-L	69785		L	69786	

⇒	⇔*	⇔.	↔
XS	31 – 49 cm	34 – 49 cm	1,5 cm
XS-S	38 – 62 cm	37 – 53 cm	2,0 cm
S-M	46 – 82 cm	47 – 69 cm	2,0 cm
M	50 – 84 cm	53 – 71 cm	2,5 cm
M-L	57 – 98 cm	60 – 91 cm	2,5 cm
L	66 – 118 cm	69 – 105 cm	2,5 cm



3M | Scotchlite Reflective Material | **3DSoft Comfort Material**



petrol/grau | teal/grey | pétrole/gris | petróleo/gris | petrolio/grigio | petrol/grå

XS	201836	XS-S	201837
S-M	201838	M	201839
M-L	201840	L	201841

blau/grau | blue/grey | bleu/gris | azul/gris | blu/grigio | blå/grå

XS	69775	XS-S	69776
S-M	69777	M	69778
M-L	69779	L	69780

oliv/grau | olive/grey | olive/gris | oliva/gris | oliva/grigio | olivenfarvet/grå

XS	201854	XS-S	201855
S-M	201856	M	201857
M-L	201858	L	201859

dunkelgrün/grau | dark green/grey | vert foncé/gris | verde oscuro/gris | verde scuro/grigio | mørkegrøn/grå

XS	69763	XS-S	69764
S-M	69765	M	69766
M-L	69767	L	69768

braun/grau | brown/grey | marron/gris | marrón/gris | marrone/grigio | brun/grå

XS	201830	XS-S	201831
S-M	201832	M	201833
M-L	201834	L	201835

hellgrau/grau | light grey/grey | gris clair/gris | gris claro/gris | grigio chiaro/grigio | lysegrå/grå

XS	69769	XS-S	69770
S-M	69771	M	69772
M-L	69773	L	69774

schwarz/grau | black/grey | noir/gris | negro/gris | nero/grigio | sort/grå

XS	201757	XS-S	201758
S-M	201753	M	201754
M-L	201755	L	201756



Die Größen S-M bis L mit zusätzlichem Griff an der Oberseite und einer Verstellmöglichkeit des Unterbruststegs.
 Sizes S-M to L with additional handle on the top and an adjustment option for the underbust band.



3D Soft Comfort Material

↕	↔*	↔.	↔
XS	31 – 49 cm	34 – 49 cm	1,5 cm
XS-S	38 – 62 cm	37 – 53 cm	2,0 cm
S-M	46 – 82 cm	47 – 69 cm	2,0 cm
M	50 – 84 cm	53 – 71 cm	2,5 cm
M-L	57 – 98 cm	60 – 91 cm	2,5 cm
L	66 – 118 cm	69 – 105 cm	2,5 cm

Sicherheitsgeschirr mit Griff MALDON

Safety harness with handle | Harnais de sécurité avec poignée | Arnés de seguridad con asa | Imbracatura antipánico con maniglia | Ekstra sikker sele med håndtag

Nylon/Polyester, bis zu 7-fache Verstellmöglichkeit, mit abnehmbarem Taillengurt, mit gepolstertem Griff (ab Gr. S-M), durch 3M™ Scotchlite™ Reflective Material stark reflektierend, weich gepolstert, hervorragende Passform | Nylon/Polyester, up to 7-way adjustment, with detachable waist belt, with padded handle (from size S-M), highly reflective due to 3M™ Scotchlite™ Reflective Material, softly padded, excellent fit | Nylon/Polyester, réglable jusqu'à 7 fois, avec ceinture amovible, avec poignée rembourrée (à partir de la taille S-M), fortement réfléchissant grâce au 3M™ Scotchlite™ Reflective Material, rembourrage doux, excellente tenue | Nylon/Poliéster, ajuste de hasta 7 posiciones, con cinturón desmontable, con asa acolchada (a partir de la talla S-M), altamente reflectante gracias al 3M™ Scotchlite™ Reflective Material, suavemente acolchado, excelente ajuste | Nylon/Poliestere, regolazione fino a 7 posizioni, con cintura staccabile, con maniglia imbottita (dalla taglia S-M), altamente riflettente grazie al 3M™ Scotchlite™ Reflective Material, morbidamente imbottito, ottima vestibilità | Nylon/Polyester, op til 7-vejs justering, med aftageligt taljebelte, med polstret håndtag (fra størrelse S-M), stærkt reflekterende takket være 3M™ Scotchlite™ Reflective Material, blødt polstret, fremragende pasform

orange | orange | orange | naranja | arancione | orange

XS	69649	XS-S	69650
S-M	69651	M	69652
M-L	69653	L	69654

petrol | teal | pétrole | petróleo | petrolio | petrol

XS	69643	XS-S	69644
S-M	69645	M	69646
M-L	69647	L	69648

schwarz | black | noir | negro | nero | sort

XS	69637	XS-S	69638
S-M	69639	M	69640
M-L	69641	L	69642

3M | Scotchlite
Reflective Material



AUSBRUCHSICHERES
**PANIK-
GESCHIRR**
Escape-proof panic harness

Vollunterlegt mit einem angenehmen weichen Polstermaterial – damit es nirgends zwickt.
Fully underlaid with a pleasantly soft padding material - so that it doesn't pinch anywhere!

Effizienter Einsatz von 3M™ Scotchlite™ Reflective Material für optimale Sichtbarkeit in jeder Situation.

Efficient use of 3M™ Scotchlite™ Reflective Material for optimal visibility in any situation.



Dank der bewährten Schieber lassen sich Geschirr und Taillengurt im Handumdrehen perfekt anpassen (Bis zu 7 Verstellmöglichkeiten).

Thanks to the proven sliders, the harness and waist belt can be perfectly adjusted in no time at all (Up to 7 adjustment possibilities).



Ist in einer Gefahrensituation schnelles Handeln gefragt, bietet der gepolsterte Griff die größtmögliche Sicherheit.

If quick action is required in a dangerous situation, the padded handle offers the greatest possible safety.

Rückwärtiges »Ausbrechen« aus dem Geschirr verhindert der Taillengurt zuverlässig. Nicht mehr benötigt, lässt er sich dank des quadratischen Spezialhakens einfach abnehmen.

If quick action is required in a dangerous situation, the padded handle offers the greatest possible safety.

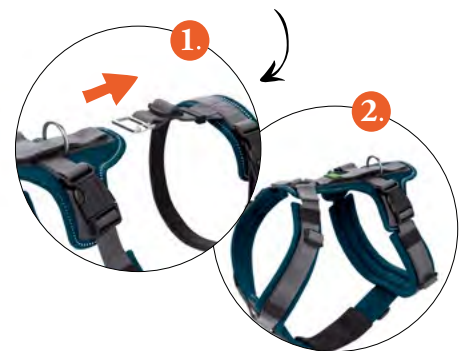

Video



**SAFETY
FIRST**





**3D Soft
Comfort
Material**

+XL
3 Meter

DIVO & MALDON

Verstellbare Führleine MALDON

Training leash | Laisse réglable | Correa ajustable | Guinzaglio da passeggio regolabile | Justerbar line

Nylon/Polyester, 3-fache Verstellmöglichkeit | *Nylon/Polyester, 3-fold adjustable* | Nylon/Polyester, 3 possibilités de réglage | *Nylon/Poliéster, 3 posibilidades de ajuste* | Nylon/Poliestere, 3 possibilità di regolazione | *Nylon/Polyester, 3-trins indstilling*

orange/grau | orange/grey | orange/gris | naranja/gris | arancione/grigio | orange/grå

15/200 68946  20/200 68947 

25/200 68948 

rot/grau | red/grey | rouge/gris | rojo/gris | rosso/grigio | rød/grå

15/200 68952  20/200 68953 

25/200 68954 

altrosa/grau | old pink/grey | vieux rose/gris | rosa viejo/gris | rosa antico/grigio | gammel pink/grå

15/200 69828  20/200 69829 

blau/grau | blue/grey | bleu/gris | azul/gris | blu/grigio | blå/grå

15/200 69825  20/200 69826 

petrol/grau | teal/grey | pétrole/gris | petróleo/gris | petrolio/grigio | petrol/grå

15/200 68949  20/200 68950 

25/200 68951 

limette/grau | lime/grey | citron vert/gris | limón/gris | limetta/grigio | limone/grå

15/200 68937  20/200 68938 

25/200 68939 

oliv/grau | olive/grey | olive/gris | oliva/gris | oliva/grigio | olivenfarvet/grå

15/200 68940  20/200 68941 

25/200 68942 

dunkelgrün/grau | dark green/grey | vert foncé/gris | verde oscuro/gris | verde scuro/grigio | mørkegrøn/grå

15/200 69819  20/200 69820 

braun/grau | brown/grey | marron/gris | marrón/gris | marrone/grigio | brun/grå

15/200 68943  20/200 68944 

25/200 68945 

● grau/grau | grey/grey | gris/gris | gris/gris | grigio/grigio | grå/grå

15/200 67640  15/300 67643 

20/200 67641  20/300 67644 

25/200 67642  25/300 67645 

hellgrau/grau | light grey/grey | gris clair/gris | gris claro/gris | grigio chiaro/grigio | lysegrå/grå

15/200 69822  20/200 69823 

schwarz/grau | black/grey | noir/gris | negro/gris | nero/grigio | sort/grå

15/200 68955  20/200 68956 

25/200 68957 

NEW FEATURE



3D Soft
Comfort
Material



⇒	↔*	↔.	↔
XS	29 – 39 cm	34 – 47 cm	1,5 cm
S	34 – 46 cm	45 – 56 cm	1,5 cm
S-M	40 – 54 cm	52 – 68 cm	2,0 cm
M	45 – 60 cm	56 – 73 cm	2,0 cm
L	56 – 80 cm	72 – 100 cm	2,5 cm
L-XL	64 – 91 cm	79 – 107 cm	2,5 cm

Geschirr DIVO CAMOUFLAGE

Harness | Harnais | Arnés | Pettorina | Sele

Nylon/Polyester, 5-fache Verstellmöglichkeit, durch 3M™ Scotchlite™ Reflective Material stark reflektierend | Nylon/Polyester, 5-fold adjustable, highly reflective with 3M™ Scotchlite™ Reflective Material | Nylon/polyester, 5 possibilités de réglage, est très réfléchissant grâce à des éléments 3M™ Scotchlite™ Reflective Material | Nylon/Poliéster, 5 posibilidades de ajuste, es altamente reflectante gracias a los elementos 3M™ Scotchlite™ Reflective Material | Nylon/Poliestere, 5 possibilità di regolazione, è altamente catarinfrangente grazie agli elementi 3M™ Scotchlite™ Reflective Material | Nylon/Polyester, 5-trins indstilling, stærkt reflekterende 3M™ Scotchlite™ Reflective Material elementer

beige | tan | beige | beige | beige | beige

XS 69453 S 69454

S-M 69455 M 69456

L 69457 L-XL 69458

rosa | light pink | rose clair | rosa pálido | rosa | lyserød

XS 69459 S 69460

S-M 69461 M 69462

L 69463 L-XL 69464

grün | green | vert | verde | verde | grøn

XS 69447 S 69448

S-M 69449 M 69450

L 69451 L-XL 69452

3M | Scotchlite
Reflective Material



PerfectFIT

3D Soft Comfort Material
Soft-Polsterung
Soft padding

5-fach verstellbar
5-fold adjustable

NEW
feature

Zusätzlicher Einstieg von vorne.
Besonders geeignet für kopfscheue Hunde.
*Additional entry from the front.
Especially suitable for head-shy dogs.*

3M | Scotchlite
Reflective Material

Stark reflektierend durch
3M™ Scotchlite™ Reflective Material
*Highly reflective thanks to
3M™ Scotchlite™ Reflective Material*



Mit zweitem D-Ring im Brustbereich
zum Anleinen für bessere Kontrolle.
*With second D-ring in the chest area
for leashing for better cont*

NEW FEATURE



3D Soft
Comfort
Material



⇒	↔*	↔.	↔
XS	29 – 39 cm	34 – 47 cm	1,5 cm
S	34 – 46 cm	45 – 56 cm	1,5 cm
S-M	40 – 54 cm	52 – 68 cm	2,0 cm
M	45 – 60 cm	56 – 73 cm	2,0 cm
L	56 – 80 cm	72 – 100 cm	2,5 cm
L-XL	64 – 91 cm	79 – 107 cm	2,5 cm

Geschirr Divo Up

Harness | Harnais | Arnés | Pettorina | Sele

Polyester, 5-fache Verstellmöglichkeit, durch 3M™ Scotchlite™ Reflective Material stark reflektierend | Polyester, 5-fold adjustable, highly reflective with 3M™ Scotchlite™ Reflective Material | Polyester, 5 possibilités de réglage, est très réfléchissant grâce à des éléments 3M™ Scotchlite™ Reflective Material | Poliéster, 5 posibilidades de ajuste, es altamente reflectante gracias a los elementos 3M™ Scotchlite™ Reflective Material | Poliestere, 5 possibilità di regolazione, è altamente catarinfrangente grazie agli elementi 3M™ Scotchlite™ Reflective Material | Polyester, 5-trins indstilling, stærkt reflekterende 3M™ Scotchlite™ Reflective Material elementer

altrosa | old pink | vieux rose | rosa viejo | rosa antico | gammel pink

XS	201771		S	201772	
S-M	201773		M	201774	
L	201775		L-XL	201776	

taupe

XS	201762		S	201763	
S-M	201764		M	201765	
L	201766		L-XL	201767	

schwarz | black | noir | negro | nero | sort

XS	201747		S	201748	
S-M	201749		M	201750	
L	201751		L-XL	201752	

3M | Scotchlite
Reflective Material



PerfectFIT

3D Soft Comfort Material
Soft-Polsterung
Soft padding



NEW feature

Zusätzlicher Einstieg von vorne.
Besonders geeignet für kopfscheue Hunde.
*Additional entry from the front.
Suitable for head-shy dogs.*

3M | **Scotchlite**
Reflective Material

Stark reflektierend durch
3M™ Scotchlite™ Reflective Material
*Highly reflective thanks to
3M™ Scotchlite™ Reflective Material*

5-fach verstellbar
5-fold adjustable



Mit zweitem D-Ring im Brustbereich
zum Anleinen für bessere Kontrolle.
*With second D-ring in the chest area
for leashing for better control.*



Verstellbare Führleine Divo Up

Training leash | Laisse réglable | Correa ajustable | Guinzaglio da passeggio regolabile | Justerbar line

Polyester, 3-fache Verstellmöglichkeit | Polyester, 3-fold adjustable | Polyester, 3 possibilités de réglage | Poliéster, 3 posibilidades de ajuste | Poliestere, 3 possibilità di regolazione | Polyester, 3-trins indstilling
altrosa | old pink | vieux rose | rosa viejo | rosa antico | gammel pink

15/200 201777  20/200 201778 

taupe

15/200 201768  20/200 201769 

schwarz | black | noir | negro | nero | sort

15/200 201759  20/200 201760 







**3D Soft
Comfort
Material**

⇒	↔*	↔.	↔
XS	19 – 32 cm	34 – 47 cm	1,5 cm
S	22 – 38 cm	45 – 56 cm	1,5 cm
S-M	30 – 42 cm	52 – 68 cm	2,0 cm
M	34 – 50 cm	56 – 73 cm	2,0 cm
L	40 – 59 cm	72 – 100 cm	2,5 cm
L-XL	46 – 67 cm	79 – 107 cm	2,5 cm

Geschirr Divo

Harness | Harnais | Arnés | Pettorina | Sele

Nylon/Polyester, 5-fache Verstellmöglichkeit, durch 3M™ Scotchlite™ Reflective Material stark reflektierend | Nylon/Polyester, 5-fold adjustable, highly reflective with 3M™ Scotchlite™ Reflective Material | Nylon/polyester, 5 possibilités de réglage, est très réfléchissant grâce à des éléments 3M™ Scotchlite™ Reflective Material | Nylon/Poliéster, 5 posibilidades de ajuste, es altamente reflectante gracias a los elementos 3M™ Scotchlite™ Reflective Material | Nylon/Poliestere, 5 possibilità di regolazione, è altamente catarinfrangente grazie agli elementi 3M™ Scotchlite™ Reflective Material | Nylon/Polyester, 5-trins indstilling, stærkt reflekterende 3M™ Scotchlite™ Reflective Material elementer

rot/grau | red/grey | rouge/gris | rojo/gris | rosso/grigio | rød/grå

XS 67629 S 67630

S-M 67631 M 67632

L 67633 L-XL 67634

hellblau/grau | light blue/grey | blue clair/gris | azul claro/gris | azzurro/grigio | lyseblå/grå

XS 67599 S 67600

S-M 67601 M 67602

L 67603 L-XL 67604

dunkelblau/grau | dark blue/grey | bleu foncé/gris | azul oscuro/gris | blu scuro/grigio | mørkeblå/grå

XS 67609 S 67610

S-M 67611 M 67612

L 67613 L-XL 67614

grün/grau | green/grey | vert/gris | verde/gris | verde/grigio | grøn/grå

XS 67589 S 67590

S-M 67591 M 67592

L 67593 L-XL 67594

braun/grau | brown/grey | marron/gris | marrón/gris | marrone/grigio | brun/grå

XS 68891 S 68892

S-M 68893 M 68894

L 68895 L-XL 68896

grau/grau | grey/grey | gris/gris | gris/gris | grigio/grigio | grå/grå

XS 67619 S 67620

S-M 67621 M 67622

L 67623 L-XL 67624

3M | **Scotchlite**
Reflective Material

Verstellbare Führleine Divo

Training leash | Laisse réglable | Correa ajustable | Guinzaglio da passeggio regolabile | Justerbar line

Nylon/Polyester, 3-fache Verstellmöglichkeit | Nylon/Polyester, 3-fold adjustable | Nylon/Polyester, 3 possibilités de réglage | Nylon/Poliéster, 3 posibilidades de ajuste | Nylon/Poliestere, 3 possibilità di regolazione | Nylon/Polyester, 3-trins indstilling

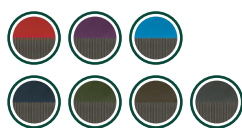

**3DSoft
Comfort
Material**



rot/grau | red/grey | rouge/gris | rojo/gris | rosso/grigio | rød/grå

15/200 69114 20/200 69115

25/200 69116

violett/grau | violet/grey | violet/gris | violeta/canoso | viola/grigio | violet/grå

15/200 69117 20/200 69118

25/200 69119

hellblau/grau | light blue/grey | blue clair/gris | azul claro/gris | azzurro/grigio | lyseblå/grå

15/200 69111 20/200 69112

25/200 69113

dunkelblau/grau | dark blue/grey | bleu foncé/gris | azul oscuro/gris | blu scuro/grigio | mørkeblå/grå

15/200 69102 20/200 69103

25/200 69104

grün/grau | green/grey | vert/gris | verde/gris | verde/grigio | grøn/grå

15/200 69105 20/200 69106

25/200 69107

braun/grau | brown/grey | marron/gris | marrón/gris | marrone/grigio | brun/grå

15/200 69099 20/200 69100

25/200 69101

grau/grau | grey/grey | gris/gris | gris/gris | grigio/grigio | grå/grå

15/200 69108 20/200 69109

25/200 69110

Führleine DIVO & MALDON

Leash | Laisse | Correa | Guinzaglio da passeggio | Line

Nylon/Polyester | Nylon/Polyester | Nylon/Polyester | Nylon/Poliéster | Nylon/Poliestere | Nylon/Polyester

grau/grau | grey/grey | gris/gris | gris/gris | grigio/grigio | grå/grå

20/100 67639



**3DSoft
Comfort
Material**



Verstellbare Führleine DIVO & MALDON

Training leash | Laisse réglable | Correa ajustable | Guinzaglio da passeggio regolabile | Justerbar line

Nylon/Polyester, 3-fache Verstellmöglichkeit | Nylon/Polyester, 3-fold adjustable | Nylon/Polyester, 3 possibilités de réglage | Nylon/Poliéster, 3 posibilidades de ajuste | Nylon/Poliestere, 3 possibilità di regolazione | Nylon/Polyester, 3-trins indstilling

grau/grau | grey/grey | gris/gris | gris/gris | grigio/grigio | grå/grå

15/200 67640 15/300 67643

20/200 67641 20/300 67644

25/200 67642 25/300 67645



**3DSoft
Comfort
Material**



+XL
3 Meter



Scotchlite
Reflective Material

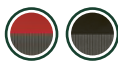

**3D Soft
Comfort
Material**

⇒	↔	↔
S	25 – 35 cm	4,0 cm
L	45 – 55 cm	4,5 cm
XL	55 – 65 cm	5,5 cm

Halsung DIVO REFLECT

Collar | Collier | Collar | Collare | Halsbånd

Nylon/Polyester, mit Zugentlastung, durch 3M™ Scotchlite™ Reflective Material stark reflektierend | *Nylon/Polyester, with pull-relief, highly reflective with 3M™ Scotchlite™ Reflective Material* | Nylon/Polyester, avec soulagement de traction, est très réfléchissant grâce à des éléments 3M™ Scotchlite™ Reflective Material | *Nylon/Poliéster, con antitirones, es altamente reflectante gracias a los elementos 3M™ Scotchlite™ Reflective Material* | Nylon/Poliestere, con antistrappo, è altamente catarinfrangente grazie agli elementi 3M™ Scotchlite™ Reflective Material | *Nylon/Polyester, med trækraftstning, stærkt reflekterende 3M™ Scotchlite™ Reflective Material elementer*

rot/grau | red/grey | rouge/gris | rojo/gris | rosso/grigio | rød/grå

S 68974 XL 68977

schwarz/grau | black/grey | noir/gris | negro/gris | nero/grigio | sort/grå

S 68964 L 68966

XL 68967



Scotchlite
Reflective Material

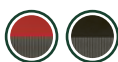

**3D Soft
Comfort
Material**

⇒	↔*	↔,	↔
XS	19 – 32 cm	34 – 47 cm	1,5 cm
S	22 – 38 cm	45 – 56 cm	1,5 cm
S-M	30 – 42 cm	52 – 68 cm	2,0 cm
M	34 – 50 cm	56 – 73 cm	2,0 cm
L	40 – 59 cm	72 – 100 cm	2,5 cm
L-XL	46 – 67 cm	79 – 107 cm	2,5 cm

Geschirr DIVO REFLECT

Harness | Harnais | Arnés | Pettorina | Sele

Nylon/Polyester, 5-fache Verstellmöglichkeit, durch 3M™ Scotchlite™ Reflective Material stark reflektierend | *Nylon/Polyester, 5-fold adjustable, highly reflective with 3M™ Scotchlite™ Reflective Material* | Nylon/Polyester, 5 possibilités de réglage, est très réfléchissant grâce à des éléments 3M™ Scotchlite™ Reflective Material | *Nylon/Poliéster, 5 posibilidades de ajuste, es altamente reflectante gracias a los elementos 3M™ Scotchlite™ Reflective Material* | Nylon/Poliestere, 5 possibilità di regolazione, è altamente catarinfrangente grazie agli elementi 3M™ Scotchlite™ Reflective Material | *Nylon/Polyester, 5-trins indstilling, stærkt reflekterende 3M™ Scotchlite™ Reflective Material elementer*

rot/grau | red/grey | rouge/gris | rojo/gris | rosso/grigio | rød/grå

XS 68968 S 68969

S-M 68970 M 68971

L 68972 L-XL 68973

schwarz/grau | black/grey | noir/gris | negro/gris | nero/grigio | sort/grå

XS 68958 S 68959

S-M 68960 M 68961

L 68962 L-XL 68963

Verstellbare Führleine DIVO REFLECT

Training leash | Laisse réglable | Correa ajustable | Guinzaglio da passeggio regolabile | Justerbar line

Nylon/Polyester, 3-fache Verstellmöglichkeit, reflektierend | *Nylon/Polyester, 3-fold adjustable, reflective* | Nylon/Polyester, 3 possibilités de réglage, réfléchissant | *Nylon/Poliéster, 3 posibilidades de ajuste, reflectante* | Nylon/Poliestere, 3 possibilità di regolazione, riflettente | *Nylon/Polyester, 3-trins indstilling, reflekterende*

rot/grau | red/grey | rouge/gris | rojo/gris | rosso/grigio | rød/grå

15/200 69120 20/200 69121

25/200 69122

schwarz/grau | black/grey | noir/gris | negro/gris | nero/grigio | sort/grå

15/200 69123 20/200 69124

25/200 69125



**3D Soft
Comfort
Material**



besonders stark
reflektierendes
Material

particularly highly reflective material





**3D Soft
Comfort
Material**

⇒	↔	↔
S-M	30 – 43 cm	2,5 cm
M-L	33 – 50 cm	2,5 cm

Halsung HILO VARIO BASIC

Collar | Collier | Collar | Collare | Halsbånd

Polyester/3D-Mesh-Material, reflektierend | Polyester/3D mesh material, reflective | Polyester/matériau mesh 3D, réfléchissant | Poliéster/Materiale mesh 3D, reflectante | Poliestere/material de malla 3D, riflettente | Polyester/3D-mesh-materiale, reflekerende

orange | orange | orange | naranja | arancione | orange

S-M 66648  M-L 66649 

rot | red | rouge | rojo | rosso | rød

S-M 66588  M-L 66589 

limette | lime | citron vert | limón | limetta | limone

S-M 66608  M-L 66609 

blau | blue | bleu | azul | blu | blå

S-M 67484  M-L 67485 

türkis | turquoise | turquoise | turquesa | turchese | turkis

S-M 67164  M-L 67165 

braun | brown | marron | marrón | marrone | brun

S-M 66668  M-L 66669 

anthrazit | anthracite | anthracite | anthracita | anthracite | antracit

S-M 66628  M-L 66629 





**3DSoft
Comfort
Material**

⇒	↔	↔
L-XL	40 – 60 cm	3,2 cm
XL	45 – 70 cm	3,8 cm

Halsung HILO VARIO PLUS

Collar | Collier | Collar | Collare | Halsbånd

Polyester/3D-Mesh-Material, reflektierend, mit Zugentlastung | Polyester/3D mesh material, reflective, with pull-relief | Polyester/matériau mesh 3D, réfléchissant, avec soulagement de traction | Poliéster/Materiale mesh 3D, reflectante, con antistrappo | Poliester/material de malla 3D, riflettente, con antistrappo | Polyester/3D-mesh-materiale, reflekterende med trækafastning

orange | orange | orange | naranja | arancione | orange

L-XL 66650  XL 66651 

rot | red | rouge | rojo | rosso | rød

L-XL 66590  XL 66591 

limette | lime | citron vert | limón | limetta | limone

L-XL 66610  XL 66611 

blau | blue | bleu | azul | blu | blå

L-XL 67486  XL 67487 

türkis | turquoise | turquoise | turquesa | turchese | turkis

L-XL 67166  XL 67167 

braun | brown | marron | marrón | marrone | brun

L-XL 66670  XL 66671 

anthrazit | anthracite | anthracite | anthracita | anthracite | antracit

L-XL 66630  XL 66631 

**ZUG-
ENTLASTUNG**
with pull-relief





3D Soft
Comfort
Material



Geschirr Hilo Comfort

Harness Hilo Comfort

Unsere Geschirre HILO COMFORT aus innovativem 3D Soft Comfort Material sind sehr leicht, weich und anschmiegsam. Durch die Verwendung von besonders voluminösem Material und der HUNTER-typischen hochwertigen Verarbeitung sind sie extrem komfortabel, da sie sich geschmeidig an den Hundekörper anschmiegen. Das sehr leichte und luftdurchlässige 3D-Mesh erfüllt darüber hinaus einen Kühleffekt an warmen Tagen, wenn das Geschirr vor dem Tragen in Wasser getaucht wird. Zudem sorgen 3M™ Scotchlite™ Reflective Material Elemente für gute Sichtbarkeit in der Dunkelheit. Ihr Liebling wird sich darin im Sommer wie im Winter - sicher aufgehoben fühlen.

Our HILO COMFORT harnesses made from innovative 3D Soft Comfort Material are very light, soft and supple. Thanks to the particularly voluminous material and the high-quality workmanship typical of HUNTER, they are extremely comfortable because they fit snugly to your dog's frame. The very light and breathable 3D mesh also provides a cooling effect on warm days, if the harness is immersed in water before it is worn. In addition, 3M™ Scotchlite™ Reflective Material elements ensure good levels of visibility in darkness. Your precious pet will definitely feel well looked after in this harness - in summer and winter alike.





Geschirr HILO COMFORT

Harness | Harnais | Arnés | Pettorina | Sele

Polyester/3D-Mesh-Material, durch 3M™ Scotchlite™ Reflective Material stark reflektierend, eng anliegend, gute Passform | *Polyester/3D mesh material, highly reflective with 3M™ Scotchlite™ Reflective Material, sits securely, snug fit* | Polyester/matériau mesh 3D, est très réfléchissant grâce à des éléments 3M™ Scotchlite™ Reflective Material, moulant, bon ajustement | *Poliéster/Materiale mesh 3D, es altamente reflectante gracias a los elementos 3M™ Scotchlite™ Reflective Material, ajustado, sujeción perfecta* | Poliestere/material de malla 3D, è altamente catarinfrangente grazie agli elementi 3M™ Scotchlite™ Reflective Material, aderente, buona vestibilità | *Polyester/3D-mesh-materiale, stærkt reflekterende 3M™ Scotchlite™ Reflective Material elementer, tetsiddende, god pasform*

STEP-IN

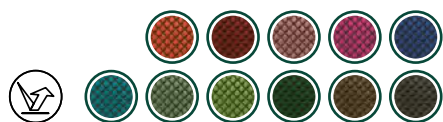

3D Soft Comfort Material

⇒	↔*	↔.
XXS	26 – 30 cm	31 – 33 cm
XXS-XS	30 – 35 cm	33 – 36 cm
XS	35 – 37 cm	36 – 40 cm
XS-S	37 – 42 cm	40 – 46 cm
S	42 – 48 cm	46 – 52 cm
S-M	48 – 55 cm	52 – 58 cm
M	55 – 60 cm	58 – 65 cm
M-L	58 – 63 cm	65 – 70 cm

3M | **Scotchlite**
Reflective Material

orange | orange | orange | naranja | arancione | orange

XXS	66661	XXS-XS	66662
XS	66663	XS-S	66664
S	66665	S-M	66666
M	66667	M-L	67466

rot | red | rouge | rojo | rosso | rød

XXS	66601	XXS-XS	66602
XS	66603	XS-S	66604
S	66605	S-M	66606
M	66607	M-L	67467

altrosa | old pink | vieux rose | rosa viejo | rosa antico | gammel pink

XXS	69787	XXS-XS	69788
XS	69789	XS-S	69790
S	69791	S-M	69792
M	69793	M-L	69794

pink | pink | rose | rosa | rosa carico | pink

XXS	69803	XXS-XS	69804
XS	69805	XS-S	69806
S	69807	S-M	69808
M	69809	M-L	69810

blau | blue | bleu | azul | blu | blå

XXS	67477	XXS-XS	67478
XS	67479	XS-S	67480
S	67481	S-M	67482
M	67483	M-L	67469



türkis | turquoise | turquoise | turquesa | turchese | turkis

XXS	67133	XXS-XS	67134
XS	67135	XS-S	67136
S	67137	S-M	67138
M	67139	M-L	67468

lindgrün | linden green | vert pâle | verde suave | verdino chiaro | lindengrøn

XXS	69795	XXS-XS	69796
XS	69797	XS-S	69798
S	69799	S-M	69800
M	69801	M-L	69802

limette | lime | citron vert | limón | limetta | limone

XXS	66621	XXS-XS	66622
XS	66623	XS-S	66624
S	66625	S-M	66626
M	66627	M-L	67465

dunkelgrün | dark green | vert foncé | verde oscuro | verde scuro | mørkegrøn

XXS	69811	XXS-XS	69812
XS	69813	XS-S	69814
S	69815	S-M	69816
M	69817	M-L	69818

braun | brown | marron | marrón | marrone | brun

XXS	66681	XXS-XS	66682
XS	66683	XS-S	66684
S	66685	S-M	66686
M	66687	M-L	67464

anthrazit | anthracite | anthracite | anthracita | anthracite | antracit

XXS	66641	XXS-XS	66642
XS	66643	XS-S	66644
S	66645	S-M	66646
M	66647	M-L	67463



■
38 x 8 x 8 cm

HILO
Perfect
MATCH

Hakenleiste zur Produktpräsentation

Hook rail for product presentation | Barre à crochets pour la présentation des produits | Barra de enganche para la presentación de productos | Guida a gancio per la presentazione del prodotto | Krogskinne til produktpräsentation

Stahl, zur übersichtlichen Präsentation aller Größen der HILO-Geschirre | *Steel, for clear presentation of all sizes of HILO harnesses* | Acier, pour une présentation claire de toutes les tailles de harnais HILO | *Acero, para una presentación clara de todos los tamaños de arnés HILO* | *Acciaio, per una presentazione chiara di tutte le dimensioni dei pettorina HILO* | *Stål, til tydelig presentation af alle størrelser af HILO-sele*

69704 

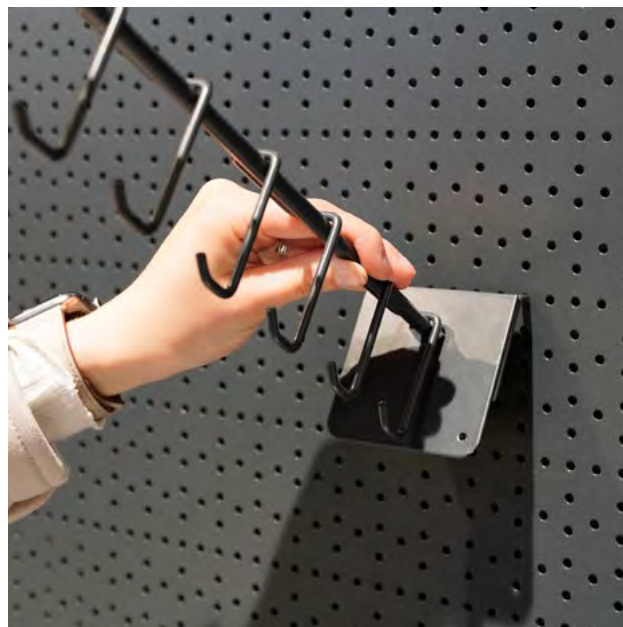

Praktische Hakenleiste,
konzipiert für HILO-Geschirre
*Practical hook rail, designed for
HILO harnesses*



Ermöglicht die übersichtliche
Präsentation aller acht Größen
Enables clear presentation of all eight sizes



Einzelne Artikel können mit einem
Handgriff entnommen werden
*Individual items can be removed
with a flick of the wrist*



Kompatibel mit allen gängigen
Lochwandsystemen
*Compatible with all standard
perforated wall systems*







3D Soft
Comfort
Material

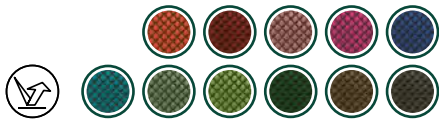

Führleine HILO

Leash | Laisse | Correa | Guinzaglio da passeggio | Line

Polyester/3D-Mesh-Material | Polyester/3D mesh material | Polyester/
matériau mesh 3D | Poliéster/Materiale mesh 3D | Poliestere/material de
malla 3D | Polyester/3D-mesh-materiale

orange | orange | orange | naranja | arancione | orange

15/140 203332 

rot | red | rouge | rojo | rosso | rød

15/140 203334 

altrosa | old pink | vieux rose | rosa viejo | rosa antico | gammel pink

15/140 203325 

pink | pink | rose | rosa | rosa carico | pink

15/140 203333 

blau | blue | bleu | azul | blu | blå

15/140 203327 

türkis | turquoise | turquoise | turquesa | turchese | turkis

15/140 203335 

lindgrün | linden green | vert pâle | verde suave | verdino chiaro |
lindengrøn

15/140 203331 

limette | lime | citron vert | limón | limetta | limone

15/140 203330 

dunkelgrün | dark green | vert foncé | verde oscuro | verde scuro |
mørkegrøn

15/140 203329 

braun | brown | marron | marrón | marrone | brun

15/140 203328 

anthrazit | anthracite | anthracite | anthracita | anthracite | antracit

15/140 203326 





**3D Soft
Comfort
Material**

Verstellbare Führleine HILO

Training leash | Laisse réglable | Correa ajustable | Guinzaglio da passeggio regolabile | Justerbar line

Polyester/3D-Mesh-Material, 15/200: auf der anderen Seite flaches schwarzes Nylon, reflektierend (20/200, 25/200) | Polyester/3D mesh material, 15/200: smooth black nylon on the other side, reflective (20/200, 25/200) | Polyester/matériau mesh 3D, 15/200: nylon noir plat de l'autre côté, réfléchissant (20/200, 25/200) | Poliéster/Materiale mesh 3D, 15/200: en el otro lado nylon plano en negro, reflectante (20/200, 25/200) | Poliestere/material de malla 3D, 15/200: sull'altro lato nylon piatto nero, riflettente (20/200, 25/200) | Polyester/3D-mesh-materiale, 15/200: på den anden side fladt sort nylon, reflekterende (20/200, 25/200)

orange | orange | orange | naranja | arancione | orange

15/200 66652  20/200 66653 

25/200 66654 

rot | red | rouge | rojo | rosso | rød

15/200 66592  20/200 66593 

25/200 66594 

altrosa | old pink | vieux rose | rosa viejo | rosa antico | gammel pink

15/200 69831  20/200 69832 

pink | pink | rose | rosa | rosa carico | pink

15/200 69837  20/200 69838 

blau | blue | bleu | azul | blu | blå

15/200 67488  20/200 67489 

25/200 67490 

türkis | turquoise | turquoise | turquesa | turchese | turkis

15/200 67168  20/200 67169 

25/200 67170 

lindgrün | linden green | vert pâle | verde suave | verdino chiaro | lindengrøn

15/200 69834  20/200 69835 

limette | lime | citron vert | limón | limetta | limone

15/200 66612  20/200 66613 

25/200 66614 

dunkelgrün | dark green | vert foncé | verde oscuro | verde scuro | mørkegrøn

15/200 69840  20/200 69841 

braun | brown | marron | marrón | marrone | brun

15/200 66672  20/200 66673 

25/200 66674 

anthrazit | anthracite | anthracite | anthracita | anthracite | antracit

15/200 66632  20/200 66633 

25/200 66634 



**3D Soft
Comfort
Material**

9,5 x 5,0 cm 6 Stck. | pcs.

Kotbeutelspender HILO

Waste bag dispenser | Distributeur de sac sanitaire | Dispensador de bolsas para excrementos | Distributore di sacchetti per escrementi | Lorteposeautomat

Polyester/3D-Mesh-Material, mit praktischem Karabiner zur variablen Befestigung, befüllbar mit handelsüblichen Kotbeutel-Rollen (nicht im Lieferumfang enthalten) | Polyester/3D mesh material, with practical carabiner for versatile fastening, able to be filled with normal-sized rolls of waste bags (not included) | Polyester/Matériau mesh 3D, avec mousqueton pratique pour fixation variable, remplissage possible avec des rouleaux de sacs à excréments standard (non inclus) | Poliéster/Materiales mesh 3D, con práctico mosquetón para fijar a medida, se rellena con rollos de bolsas para excrementos (no incluidos) | Poliestere/Material de malla 3D, con práctico moschettone per il fissaggio variabile, può essere riempito con rotoli standard di sacchetti per escrementi (non inclusi) | Polyester/3D-mesh-materiale, med praktisk karabiner til variabel fastgørelse, kan fyldes med standard hundepose-ruller (ikke inkluderet)

orange | orange | orange | naranja | arancione | orange

67473

rot | red | rouge | rojo | rosso | rød

67474

limette | lime | citron vert | limón | limetta | limone

67472

blau | blue | bleu | azul | blu | blå

67476

türkis | turquoise | turquoise | turquesa | turchese | turkis

67475

braun | brown | marron | marrón | marrone | brun

67471

anthrazit | anthracite | anthracite | anthracita | anthracite | antracit

67470

Snackbeutel

Snack bag



Dank stabilem Kunststoff-Clip kann der besonders leichte Snackbeutel HILO BASIC aus zukunftsweisendem 3D Soft Comfort Material idealerweise an den Gürtel oder Hosenbund geklemmt und nach der Befüllung mit ausreichend Snacks sicher verschlossen werden - sogar mit einer Hand, dank elastischem Kordelband. Leicht, kompakt und ein zuverlässiger Begleiter bei Ausbildung und Training Ihres Vierbeiners!

Thanks to the robust plastic clip, the particularly lightweight HILO BASIC snack bag made from pioneering 3D Soft Comfort Material can be easily fastened to your belt or waistband and be secured once full with snacks – even with one hand, thanks to the elastic cord. A lightweight, compact and reliable companion for training your dog!



Clip



3DSoft
Comfort
Material

14 x 10 x 8 cm 3 Stck. | pcs.

Snackbeutel HILO BASIC

Snack bag | Sac de récompense | Bolsa de recompensa | Borse per spuntini | Snack taske

Polyester/3D-Mesh-Material, zum Befestigen an einem Gürtel (mit Clip), ideal zur Aufbewahrung von Snacks, mit Hilfe einer Kordel verschließbar, auswaschbar | Polyester/3D mesh material, to attach to a belt (with clip), ideal for storing rewards, can be opened and closed with the help of a cord, washable | Polyester/Matériau mesh 3D, à fixer à la ceinture (avec clip), idéal pour ranger les friandises, se ferme avec un cordon, lavable | Poliéster/Materiale mesh 3D, para fijar al cinturón (con clip), ideal para guardar snacks, con cordón de cierre, puede limpiarse en húmedo | Poliestere/Material de malla 3D, per il fissaggio a una cintura (con clip), ideale per riporre gli snack, può essere chiuso con una corda, lavabile | Polyester/3D-mesh-materiale, til fastgørelse til et bælte (med klemme), ideel til opbevaring af snacks, ved hjælp af en snor kan det lases, kan vaskes

orange | orange | orange | naranja | arancione | orange

67396

rot | red | rouge | rojo | rosso | rød

67393

limette | lime | citron vert | limón | limetta | limone

67394

blau | blue | bleu | azul | blu | blå

67533

türkis | turquoise | turquoise | turquesa | turchese | turkis

67398

braun | brown | marron | marrón | marrone | brun

67397

anthrazit | anthracite | anthracite | anthracita | anthracite | antracit

67395





**EXTRA-BREIT
UNTERLEGT**
extra wide underlay

⇒	■	↔	↔
45	S-M	34 – 41 cm	4,5 cm
50	M	39 – 46 cm	4,5 cm
55	M-L	44 – 51 cm	4,5 cm
60	L	49 – 56 cm	4,5 cm
65	L-XL	54 – 61 cm	4,5 cm

**ZUG-
ENTLASTUNG**
with pull-relief

Halsband NEOPREN REFLECT BVB

Collar | Collier | Collar | Collare | Halsbånd

Nylon / Neopren, mit Zugentlastung, mit besonders breitem Unter-
material, reflektierend | Nylon / Neoprene, with pull-relief, with extra
wide lining, reflective | Nylon / Néoprène, avec soulagement de
traction, avec doublure particulièrement épaisse, réfléchissant | Nylon
/ Neopreno, con antitirones, con material inferior especialmente ancho,
reflectante | Nylon / Neoprene, con antistrappo, con un materiale
sottostante particolarmente ampio, riflettente | Nylon / Neopren, med
trækraftslastning, med særligt bredt underlagsmateriale, reflekterende

schwarz/grau | black/grey | noir/gris | negro/gris | nero/grigio | sort/grå

45	68578		50	68579	
55	68580		60	68581	
65	68582				



**3D Soft
Comfort
Material**

**KÜHL
EFFEKT**
with cooling effect

⇒	↔*	↔.
XXS	26 – 30 cm	31 – 33 cm
XXS-XS	30 – 35 cm	33 – 36 cm
XS	35 – 37 cm	36 – 40 cm
XS-S	37 – 42 cm	40 – 46 cm
S	42 – 48 cm	46 – 52 cm
S-M	48 – 55 cm	52 – 58 cm
M	55 – 60 cm	58 – 65 cm
M-L	58 – 63 cm	65 – 70 cm

Geschirr HILO COMFORT BVB

Harness | Harnais | Arnés | Pettorina | Sele

Polyester / 3D-Mesh-Material, durch 3M™ Scotchlite™ Reflective
Material stark reflektierend, eng anliegend, gute Passform | Polyester
/ 3D mesh material, highly reflective with 3M™ Scotchlite™ Reflective
Material, sits securely, snug fit | Polyester / matériau mesh 3D, est très
réfléchissant grâce à des éléments 3M™ Scotchlite™ Reflective Material,
moulant, bon ajustement | Poliéster / Materiale mesh 3D, es altamente
reflectante gracias a los elementos 3M™ Scotchlite™ Reflective Material,
ajustado, sujeción perfecta | Poliestere / material de malla 3D, è altamen-
te catarinfrangente grazie agli elementi 3M™ Scotchlite™ Reflective Ma-
terial, aderente, buona vestibilità | Polyester / 3D-mesh-materiale, stærkt
reflekterende 3M™ Scotchlite™ Reflective Material elementer, tattsiddende,
god pasform

gelb | yellow | jaune | amarillo | giallo | gul

XXS	68586		XXS-XS	68587	
XS	68588		XS-S	68589	
S	68590		S-M	68591	
M	68592		M-L	68593	



Scotchlite
Reflective Material





BVB
09 **3D Soft
Comfort
Material**

Verstellbare Führleine HILO BVB

Training leash | Laisse réglable | Correa ajustable | Guinzaglio da passeggio regolabile | Justerbar line

Polyester/3D-Mesh-Material, 3-fache Verstellmöglichkeit | *Polyester/3D mesh material, 3-fold adjustable* | Polyester/matériau mesh 3D, 3 possibilités de réglage | *Poliéster/Materiale mesh 3D, 3 posibilidades de ajuste* | Poliestere/material de malla 3D, 3 possibilità di regolazione | *Polyester / 3D-mesh-materiale, Polyester/3D-mesh-materiale, 3-trins indstilling*

gelb | yellow | jaune | amarillo | giallo | gul

15/200 68583  25/200 68585 



Clip

BVB
09 **3D Soft
Comfort
Material**

Snackbeutel HILO BASIC BVB



Snack bag | Sac de récompense | Bolsa de recompensa | Borse per spuntini | Snack taske

Polyester / 3D-Mesh-Material, zum Befestigen an einem Gürtel (mit Clip), ideal zur Aufbewahrung von Snacks, mit Hilfe einer Kordel verschließbar, auswaschbar | *Polyester / 3D mesh material, to attach to a belt (with clip), ideal for storing rewards, can be opened and closed with the help of a cord, washable* | Polyester / Matériau mesh 3D, à fixer à la ceinture (avec clip), idéal pour ranger les friandises, se ferme avec un cordon, lavable | *Poliéster / Materiale mesh 3D, para fijar al cinturón (con clip), ideal para guardar snacks, con cordón de cierre, puede limpiarse en húmedo* | Poliestere / Material de malla 3D, per il fissaggio a una cintura (con clip), ideale per riporre gli snack, può essere chiuso con una corda, lavabile | *Polyester / 3D-mesh-materiale, til fastgørelse til et bælte (med klemme), ideel til opbevaring af snacks, ved hjælp af en snor kan det lases, kan vaskes*

gelb | yellow | jaune | amarillo | giallo | gul

68594 



 14 x 10 x 8 cm  3 Stck. | pcs.



**EXTRA-BREIT
UNTERLEGT**

extra wide underlaid

**ZUG-
ENTLASTUNG**

with pull-relief

⇒	■i	↔	↔
45	S-M	34 – 41 cm	4,5 cm
50	M	39 – 46 cm	4,5 cm
55	M-L	44 – 51 cm	4,5 cm
60	L	49 – 56 cm	4,5 cm
65	L-XL	54 – 61 cm	4,5 cm

Halsband NEOPREN REFLECT FC BAYERN MÜNCHEN

Collar | Collier | Collar | Collare | Halsbånd

Nylon / Neopren, mit Zugentlastung, mit besonders breitem Unter-
material, reflektierend | *Nylon / Neoprene, with pull-relief, with extra
wide lining, reflective* | Nylon / Néoprène, avec soulagement de
traction, avec doublure particulièrement épaisse, réfléchissant | *Nylon
/ Neopreno, con antitirone, con material inferior especialmente ancho,
reflectante* | Nylon / Neoprene, con antistrappo, con un materiale
sottostante particolarmente ampio, riflettente | *Nylon / Neopren, med
trækraftslastning, med særligt bredt underlagsmateriale, reflekterende*

rot/grau | red/grey | rouge/gris | rojo/gris | rosso/grigio | rød/grå

45	69242		50	69243	
55	69244		60	69245	
65	69246				



STEP-IN



**3D Soft
Comfort
Material**

Geschirr HILO COMFORT FC BAYERN MÜNCHEN

Harness | Harnais | Arnés | Pettorina | Sele

Polyester / 3D-Mesh-Material, durch 3M™ Scotchlite™ Reflective
Material stark reflektierend, eng anliegend, gute Passform | *Polyester
/ 3D mesh material, highly reflective with 3M™ Scotchlite™ Reflective
Material, sits securely, snug fit* | Polyester / matériau mesh 3D, est très
réfléchissant grâce à des éléments 3M™ Scotchlite™ Reflective Material,
moulant, bon ajustement | *Poliéster / Materiale mesh 3D, es altamente
reflectante gracias a los elementos 3M™ Scotchlite™ Reflective Material,
ajustado, sujeción perfecta* | Poliestere / material de malla 3D, è altamen-
te catarinfrangente grazie agli elementi 3M™ Scotchlite™ Reflective Ma-
terial, aderente, buona vestibilità | *Polyester / 3D-mesh-materiale, stærkt
reflekterende 3M™ Scotchlite™ Reflective Material elementer, tetsiddende,
god pasform*

rot | red | rouge | rojo | rosso | rød

XXS	69250		XXS-XS	69251	
XS	69252		XS-S	69253	
S	69254		S-M	69255	
M	69256		M-L	69257	



Scotchlite
Reflective Material

**KÜHL
EFFEKT**

with cooling effect

⇒	↔*	↔.
XXS	26 – 30 cm	31 – 33 cm
XXS-XS	30 – 35 cm	33 – 36 cm
XS	35 – 37 cm	36 – 40 cm
XS-S	37 – 42 cm	40 – 46 cm
S	42 – 48 cm	46 – 52 cm
S-M	48 – 55 cm	52 – 58 cm
M	55 – 60 cm	58 – 65 cm
M-L	58 – 63 cm	65 – 70 cm



**3D Soft
Comfort
Material**

Verstellbare Führleine HILO FC BAYERN MÜNCHEN

Training leash | Laisse réglable | Correa ajustable | Guinzaglio da passeggio regolabile | Justerbar line

Polyester/3D-Mesh-Material, 3-fache Verstellmöglichkeit | Polyester/3D mesh material, 3-fold adjustable | Polyester/matériau mesh 3D, 3 possibilités de réglage | Poliéster/Materiale mesh 3D, 3 posibilidades de ajuste | Poliestere/material de malla 3D, 3 possibilità di regolazione | Polyester / 3D-mesh-materiale, Polyester/3D-mesh-materiale, 3-trins indstilling

rot | red | rouge | rojo | rosso | rød

15/200 69247  20/200 69248 

25/200 69249 



Clip



**3D Soft
Comfort
Material**

Snackbeutel HILO BASIC FC BAYERN MÜNCHEN

Snack bag | Sac de récompense | Bolsa de recompensa | Borse per spuntini | Snack taske

Polyester / 3D-Mesh-Material, zum Befestigen an einem Gürtel (mit Clip), ideal zur Aufbewahrung von Snacks, mit Hilfe einer Kordel verschließbar, auswaschbar | Polyester / 3D mesh material, to attach to a belt (with clip), ideal for storing rewards, can be opened and closed with the help of a cord, washable | Polyester / Matériau mesh 3D, à fixer à la ceinture (avec clip), idéal pour ranger les friandises, se ferme avec un cordon, lavable | Poliéster / Materiale mesh 3D, para fijar al cinturón (con clip), ideal para guardar snacks, con cordón de cierre, puede limpiarse en húmedo | Poliestere / Material de malla 3D, per il fissaggio a una cintura (con clip), ideale per riporre gli snack, può essere chiuso con una corda, lavabile | Polyester / 3D-mesh-materiale, til fastgørelse til et bælte (med klemme), ideel til opbevaring af snacks, ved hjælp af en snor kan det lases, kan vaskes

rot | red | rouge | rojo | rosso | rød

69258 



14 x 10 x 8 cm



3 Stck. | pcs.



Neopren

– Neoprene –

Mit der Serie NEOPREN setzt HUNTER erneut Maßstäbe und rückt eine ausgewogene Mischung aus natürlich-klassischen als auch trendigen Modifarben in ansprechenden Kombinationen in den Fokus. Moderne Hundehalter werden die Produkte lieben, denn die Kombination aus strapazierfähigem Nylon-Material und weicher Polsterung aus textilmanteltem Neopren ist geradezu ideal für Hunde im Alltag und bei der Ausübung sportlicher Aktivitäten.

HUNTER is once again setting benchmarks with its NEOPREN series, and is shifting the focus onto a balanced mixture of natural and classical as well as stylish trend colours in attractive combinations. Modern dog owners will love the products, for the combination of durable nylon material and soft padding made from textile-coated neoprene is absolutely ideal for dogs in everyday life and when performing sporty activities.



Halsung NEOPREN VARIO PLUS

Collar | Collier | Collar | Collare | Halsbånd

Nylon/Neopren, mit Zugentlastung | Nylon/Neoprene, with pull-relief | Nylon/Néoprène, avec soulagement de traction | Nylon/Neopreno, con antitirones | Nylon/Neoprene, con antistrappo | Nylon/Neopren, med trækraftsløstning



Zwischengrößen:
Extra breit für
mehr Komfort
Intermediate sizes:
Extra wide for
more comfort

⇒	↔	↔
XS-S	28 – 30 cm	1,5 cm
S	30 – 35 cm	1,5 cm
S	30 – 35 cm	2,0 cm
S-M	35 – 40 cm	2,0 cm
M	40 – 45 cm	2,0 cm
M-L	45 – 50 cm	2,0 cm
M-L	45 – 50 cm	2,5 cm
L	50 – 55 cm	2,5 cm
L-XL	55 – 60 cm	2,5 cm
XL	60 – 65 cm	2,5 cm

ZUG-ENTLASTUNG
with pull-relief

pfirsich/grau | peach/grey | pêche/gris | melocotón/gris | pesca/grigio | fersken/grå

XS-S/1,5 203265 | S/1,5 203266

S-M/2,0 203267 | M/2,0 203268

M-L/2,0 203269 | L/2,5 203270

L-XL/2,5 203271

kupfer/grau | copper/grey | cuivre/gris | cobre/gris | rame/grigio | kobber/grå

XS-S/1,5 203295 | S/1,5 203296

S-M/2,0 203297 | M/2,0 203298

M-L/2,0 203299 | L/2,5 203300

L-XL/2,5 203301

rot/schwarz | red/black | rouge/noir | rojo/negro | rosso/nero | rød/sort

XS-S/1,5 62170 | S/1,5 62176

S/2,0 64160 | S-M/2,0 62182

M/2,0 62188 | M-L/2,0 62194

M-L/2,5 64161 | L/2,5 62200

L-XL/2,5 62206 | XL/2,5 62212

lavendel/grau | lavender/grey | lavande/gris | lavanda/gris | lavanda/grigio | lavendel/grå

XS-S/1,5 203280 | S/1,5 203281

S-M/2,0 203282 | M/2,0 203283

M-L/2,0 203284 | L/2,5 203285

L-XL/2,5 203286

matcha/grau | matcha/grey | matcha/gris | matcha/gris | matcha/grigio | matcha/grå

XS-S/1,5 203310 | S/1,5 203311

S-M/2,0 203312 | M/2,0 203313

M-L/2,0 203314 | L/2,5 203315

L-XL/2,5 203316

oliv/schwarz | olive/black | olive/noir | oliva/negro | oliva/nero | olivenfarvet/sort

XS-S/1,5 62173 | S/1,5 62179

S/2,0 64155 | S-M/2,0 62185

M/2,0 62191 | M-L/2,0 62197

M-L/2,5 64156 | L/2,5 62203

L-XL/2,5 62209

braun/karamell | brown/caramel | marron/caramel | marrón/caramelo | marrone/caramello | brun/karamel

XS-S/1,5 62171 | S/1,5 62177

S/2,0 64140 | S-M/2,0 62183

M/2,0 62189 | M-L/2,0 62195

M-L/2,5 64141 | L/2,5 62201

L-XL/2,5 62207 | XL/2,5 62213

schwarz/grau | black/grey | noir/gris | negro/gris | nero/grigio | sort/grå

XS-S/1,5 62169 | S/1,5 62175

S/2,0 64165 | S-M/2,0 62181

M/2,0 62187 | M-L/2,0 62193

M-L/2,5 64166 | L/2,5 62199

L-XL/2,5 62205 | XL/2,5 62211



**EXTRA-BREIT
UNTERLEGT**
extra wide underlaid

**ZUG-
ENTLASTUNG**
with pull-relief

⇒	■	↔	↔
45	S-M	34 – 41 cm	4,5 cm
50	M	39 – 46 cm	4,5 cm
55	M-L	44 – 51 cm	4,5 cm
60	L	49 – 56 cm	4,5 cm
65	L-XL	54 – 61 cm	4,5 cm

Halsband NEOPREN REFLECT

Collar | Collier | Collar | Collare | Halsbånd

Nylon/Neopren, mit Zugentlastung, mit besonders breitem Unter-
material, reflektierend | Nylon/Neoprene, with pull-relief, with extra wide
lining, reflective | Nylon/Néoprène, avec soulagement de traction, avec
doubleure particulièrement épaisse, réfléchissant | Nylon/Neopreno, con
antistrappo, con material inferior especialmente ancho, reflectante | Nylon/
Neoprene, con antistrappo, con un materiale sottostante particolar-
mente ampio, riflettente | Nylon/Neopren, med trækraftstning, med
særligt bredt underlagsmateriale, reflekterende

rot/schwarz | red/black | rouge/noir | rojo/negro | rosso/nero | rød/sort

45 64110 50 64111

55 64112 60 64113

65 64114

braun/karamell | brown/caramel | marron/caramel | marrón/caramelo |
marrone/caramello | brun/karamel

45 64091 50 64092

55 64093 60 64094

65 64095

schwarz/grau | black/grey | noir/gris | negro/gris | nero/grigio | sort/grå

45 64117 50 64118

55 64119 60 64120

65 64121



Eine umlaufende Paspel aus stark reflektierendem 3M™ Scotchlite™ Reflective Material bietet die notwendige Sichtbarkeit bei Dämmerung und Dunkelheit im Straßenverkehr.

All-round piping made from highly reflective 3M™ Scotchlite™ Reflective material provides the necessary visibility at dusk and in the dark in road traffic.



3M

Scotchlite™
Reflective Material

Stark reflektierend durch 3M™ Scotchlite™ Reflective Material.
Highly reflective thanks to 3M™ Scotchlite™ Reflective Material.

Der an der vorderen Oberseite angebrachte D-Ring dient zum schnellen Befestigen an der Leine.
The D-ring attached to the top front is used for quick attachment to the leash.



Ein leichter Kunststoffverschluss ermöglicht ein schnelles und bequemes Ein- und Aussteigen.
A lightweight plastic fastener enables quick and easy entry and exit.

Äußerst strapazierfähiges, aber leicht zu reinigendes Nylon-Außenmaterial.
Extremely hard-wearing but easy-to-clean nylon outer material.

Weich gepolstertes Neopren für zusätzlichen Tragekomfort.
Soft padded neoprene for additional wearing comfort.

Das Geschirr kann an drei verschiedenen Stellen individuell an die Größe des Hundes angepasst werden.
The harness can be individually adjusted to the dog's size at three different points.





Soft-Polsterung
Soft padding



⇒	↔	↔	↔
S	39 cm	42 – 53 cm	1,5 cm
M/1	42 cm	53 – 65 cm	2,0 cm
M/2	52 cm	58 – 72 cm	2,0 cm
L	65 cm	72 – 91 cm	2,5 cm
L-XL	72 cm	77 – 100 cm	2,5 cm

Geschirr NEOPREN

Harness | Harnais | Arnés | Pettorina | Sele

Nylon/Neopren, 3-fache Verstellmöglichkeit, durch 3M™ Scotchlite™ Reflective Material stark reflektierend | Nylon/Neoprene, 3-fold adjustable, highly reflective with 3M™ Scotchlite™ Reflective Material | Nylon/Néoprène, 3 possibilités de réglage, est très réfléchissant grâce à des éléments 3M™ Scotchlite™ Reflective Material | Nylon/Neopreno, 3 posibilidades de ajuste, es altamente reflectante gracias a los elementos 3M™ Scotchlite™ Reflective Material | Nylon/Neoprene, 3 possibilità di regolazione, è altamente catarinfrangente grazie agli elementi 3M™ Scotchlite™ Reflective Material | Nylon/Neopren, 3-trins indstilling, stærkt reflekterende 3M™ Scotchlite™ Reflective Material elementer

pfirsich/grau | peach/grey | pêche/gris | melocotón/gris | pesca/grigio | fersken/grå

S 203272 M/1 203273

M/2 203274 L 203275

kupfer/grau | copper/grey | cuivre/gris | cobre/gris | rame/grigio | kobber/grå

S 203302 M/1 203303

M/2 203304 L 203305

rot/schwarz | red/black | rouge/noir | rojo/negro | rosso/nero | rød/sort

S 62254 M/1 62260

M/2 62266 L 62272

L-XL 62278

lavendel/grau | lavender/grey | lavande/gris | lavanda/gris | lavanda/grigio | lavendel/grå

S 203287 M/1 203288

M/2 203289 L 203290

matcha/grau | matcha/grey | matcha/gris | matcha/gris | matcha/grigio | matcha/grå

S 203317 M/1 203318

M/2 203319 L 203320

oliv/schwarz | olive/black | olive/noir | oliva/negro | oliva/nero | olivenfarvet/sort

S 62257 M/1 62263

M/2 62269 L 62275

braun/karamell | brown/caramel | marron/caramel | marrón/caramelo | marrone/caramello | brun/karamel

S 62255 M/1 62261

M/2 62267 L 62273

L-XL 62279

schwarz/grau | black/grey | noir/gris | negro/gris | nero/grigio | sort/grå

S 62253 M/1 62259

M/2 62265 L 62271

L-XL 62277





STEP-IN



Soft-Polsterung
Soft padding



Geschirr NEOPREN VARIO QUICK

Harness | Harnais | Arnés | Pettorina | Sele

Nylon/Neopren, ideale Passform, durch 3M™ Scotchlite™ Reflective Material stark reflektierend, einfacher Einstieg von oben, weich gepolstert, Bauch- und Brustriemen verstellbar | Nylon/Neoprene, perfect fit, highly reflective with 3M™ Scotchlite™ Reflective Material, easy access from above, soft padding, adjustable neck and breast strap | Nylon/Néoprène, forme ergonomique idéale, est très réfléchissant grâce à des éléments 3M™ Scotchlite™ Reflective Material, accès facile par le haut, doublure souple, sangles de ventre et de poitrine réglables | Nylon/Neopreno, adaptación perfecta, es altamente reflectante gracias a los elementos 3M™ Scotchlite™ Reflective Material, entrada fácil por la parte superior, suave acolchado, correas ajustables para vientre y pecho | Nylon/Neoprene, forma che si adatta perfettamente, è altamente catarinfrangente grazie agli elementi 3M™ Scotchlite™ Reflective Material, salita facile dalla parte anteriore, soffice imbottitura, cinta al collo e al torace regolabile | Nylon/Neopren, ideel pasform, stærkt reflekterende 3M™ Scotchlite™ Reflective Material elementer, enkel indstigning fra oven, blødt polstret, mave- og brystrem indstillelig

rot/schwarz | red/black | rouge/noir | rojo/negro | rosso/nero | rød/sort

S 64213 M 64214

L 64215

braun/karamell | brown/caramel | marron/caramel | marrón/caramelo | marrone/caramello | brun/karamel

S 64193 M 64194

L 64195

schwarz/grau | black/grey | noir/gris | negro/gris | nero/grigio | sort/grå

S 64218 M 64219

L 64220

3M | **Scotchlite**
Reflective Material

⇒	↔	↔
S	45 – 55 cm	1,5 cm
M	55 – 70 cm	1,5 cm
L	67 – 80 cm	2,5 cm



**NEW
colours**

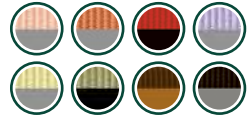

+XL
3 Meter

Extra lange Leine
long leash

Verstellbare Führleine NEOPREN

Training leash | Laisse réglable | Correa ajustable | Guinzaglio da passeggio regolabile | Justerbar line

Nylon/Neopren, 3-fache Verstellmöglichkeit | *Nylon/Neoprene, 3-fold adjustable* | Nylon/Néoprène, 3 possibilités de réglage | *Nylon/Neopreno, 3 posibilidades de ajuste* | Nylon/Neoprene, 3 possibilità di regolazione | *Nylon/Neopren, 3-trins indstilling-*

pfirsich/grau | peach/grey | pêche/gris | melocotón/gris | pesca/grigio | fersken/grå

10/200 203276 15/200 203277

20/200 203278 25/200 203279

kupfer/grau | copper/grey | cuivre/gris | cobre/gris | rame/grigio | kobber/grå

10/200 203306 15/200 203307

20/200 203308 25/200 203309

rot/schwarz | red/black | rouge/noir | rojo/negro | rosso/nero | rød/sort

10/200 65475 15/200 62302

15/300 67862 20/200 62308

20/300 67863 25/200 62314

25/300 67864

lavendel/grau | lavender/grey | lavande/gris | lavanda/gris | lavanda/grigio | lavendel/grå

10/200 203291 15/200 203292

20/200 203293 25/200 203294

matcha/grau | matcha/grey | matcha/gris | matcha/gris | matcha/grigio | matcha/grå

10/200 203321 15/200 203322

20/200 203323 25/200 203324

oliv/schwarz | olive/black | olive/noir | oliva/negro | oliva/nero | olivenfarvet/sort

10/200 65473 15/200 62305

20/200 62311 25/200 62317

braun/karamell | brown/caramel | marron/caramel | marrón/caramelo | marrone/caramello | brun/karamel

10/200 65469 15/200 62303

15/300 67859 20/200 62309

20/300 67860 25/200 62315

25/300 67861

schwarz/grau | black/grey | noir/gris | negro/gris | nero/grigio | sort/grå

10/200 65476 15/200 62301

15/300 67856 20/200 62307

20/300 67857 25/200 62313

25/300 67858





Halsung VARIO BASIC

Collar | Collier | Collar | Collare | Halsbånd

Nylon

orange | orange | orange | naranja | arancione | orange

S/1,0 42590  M/1,5 42591 

rot | red | rouge | rojo | rosso | rød

S/1,0 35370  S/1,5 65913 

M/1,5 35390  M/2,0 65914 

petrol | teal | pétrole | petróleo | petrolio | petrol

S/1,0 47873  M/1,5 47874 

rauchblau | smoky blue | bleu fumé | azul ahumado | blu fumo | røgfارvet blå

S/1,0 203343  M/1,5 203344 

braun | brown | marron | marrón | marrone | brun

S/1,0 42801  S/1,5 65919 

M/1,5 42802  M/2,0 65920 

grau | grey | gris | gris | grigio | grå

S/1,0 47523  M/1,5 47524 

schwarz | black | noir | negro | nero | sort

S/1,0 35374  S/1,5 65916 

M/1,5 35394  M/2,0 65917 

↗	↔	↔
S	22 – 35 cm	1,0 cm
S	22 – 35 cm	1,5 cm
M	30 – 45 cm	1,5 cm
M	30 – 45 cm	2,0 cm





NEW
colour



	↔	↔
M-L	35 – 53 cm	2,0 cm
M-L	35 – 53 cm	2,5 cm
L-XL	40 – 63 cm	2,5 cm

Halsung VARIO PLUS

Collar | Collier | Collar | Collare | Halsbånd

Nylon, mit Zugentlastung | Nylon, with pull-relief | Nylon, avec soulagement de traction | Nylon, con antitirones | Nylon, con antistrappo | Nylon, med trækafastning

orange | orange | orange | naranja | arancione | orange

M-L/2,0 42592  L-XL/2,5 42593 

rot | red | rouge | rojo | rosso | rød

M-L/2,0 35359  M-L/2,5 65915 

L-XL/2,5 35367 

petrol | teal | pétrole | petróleo | petrolio | petrol

M-L/2,0 47875  L-XL/2,5 47876 

rauchblau | smoky blue | bleu fumé | azul ahumado | blu fumo | rogfarvet blå

M-L/2,0 203345  L-XL/2,5 203346 

braun | brown | marron | marrón | marrone | brun

M-L/2,0 42803  M-L/2,5 65921 

L-XL/2,5 42804 

grau | grey | gris | gris | grigio | grå

M-L/2,0 47525  L-XL/2,5 47526 

schwarz | black | noir | negro | nero | sort

M-L/2,0 35361  M-L/2,5 65918 

L-XL/2,5 35369 

ZUG-
ENTLASTUNG
with pull-relief





Halsung VARIO BASIC ALU-STRONG

Collar | Collier | Collar | Collare | Halsbånd

Nylon, Steckverschluss aus Aluminium, Metall-Schieber | *Nylon, buckle made of aluminum, metal slide* | Nylon, fermeture à clips pratique d'aluminium, coulisseau en métal | *Nylon, cierre a presión de aluminio, pasador metálico* | Nylon, chiusura a scatto in alluminio, fibbia di metallo | *Nylon, kliklås af aluminium, metalspændet*

orange | orange | orange | naranja | arancione | orange

M 43966 L 43967

XL 43968

rot | red | rouge | rojo | rosso | rød

M 43514 L 43515

XL 43516

petrol | teal | pétrole | petróleo | petrolio | petrol

M 47877 L 47878

XL 47879

rauchblau | smoky blue | bleu fumé | azul ahumado | blu fumo | røgfارvet blå

M 203340 L 203341

XL 203342

braun | brown | marron | marrón | marrone | brun

M 43969 L 43970

XL 43971

grau | grey | gris | gris | grigio | grå

M 47539 L 47540

XL 47541

schwarz | black | noir | negro | nero | sort

M 43508 L 43509

XL 43510

↕	↔	↔
M	30 – 45 cm	1,5 cm
L	40 – 55 cm	2,0 cm
XL	45 – 65 cm	2,5 cm





Geschirr VARIO RAPID

Harness | Harnais | Arnés | Pettorina | Sele

Nylon, 5-fache Verstellmöglichkeit | Nylon, 5-fold adjustable | Nylon, 5 possibilités de réglage | Nylon, 5 posibilidades de ajuste | Nylon, 5 possibilità di regolazione | Nylon, 5-trins indstilling

orange | orange | orange | naranja | arancione | orange

XS-S 42595  S-M 42596 

M-L 42597 

rot | red | rouge | rojo | rosso | rød

XS-S 35730  S-M 35750 

M-L 35770 

petrol | teal | pétrole | petróleo | petrolio | petrol

XS-S 47881  S-M 47882 

M-L 47883 

braun | brown | marron | marrón | marrone | brun

XS-S 42798  S-M 42799 

M-L 42800 

grau | grey | gris | gris | grigio | grå

XS-S 47528  S-M 47529 

M-L 47530 

schwarz | black | noir | negro | nero | sort

XS-S 35734  S-M 35754 

M-L 35774 

↕	↔*	↔.	↔
XS-S	34 – 46 cm	38 – 52 cm	1,5 cm
S-M	48 – 71 cm	48 – 70 cm	2,0 cm
M-L	54 – 77 cm	64 – 100 cm	2,5 cm



mit zusätzlichem
abnehmbarem Bauchgurt
with an additional removable stomach strap

Sicherheitsgeschirr VARIO RAPID

Safety harness | Harnais de sécurité | Arnés de seguridad |
Imbracatura antipánico | Ekstra sikker sele

Nylon, bis zu 7-fache Verstellmöglichkeit, mit abnehmbarem Taillengurt | Nylon, up to 7-way adjustment, with detachable waist belt | Nylon, ajustable jusqu'à 7 fois, avec sangle de taille amovible | Nylon, ajuste de hasta 7 posiciones, con cinturón desmontable | Nylon, regolazione fino a 7 posizioni, con cintura in vita staccabile | Nylon, op til 7-vejs justering, med aftageligt taljebælte

rot | red | rouge | rojo | rosso | rød

XS-S 66192 S-M 66193

M-L 66194

braun | brown | marron | marrón | marrone | brun

XS-S 66196 S-M 66197

M-L 66198

schwarz | black | noir | negro | nero | sort

XS-S 66200 S-M 66201

M-L 66202

AUSBRUCHSICHERES
**PANIK-
GESCHIRR**
Escape-proof panic harness

↕	↔	↔	↔
XS-S	29 – 39 cm	38 – 52 cm	1,5 cm
S-M	36 – 51 cm	48 – 70 cm	2,0 cm
M-L	47 – 66 cm	64 – 100 cm	2,5 cm

**SAFETY
FIRST**

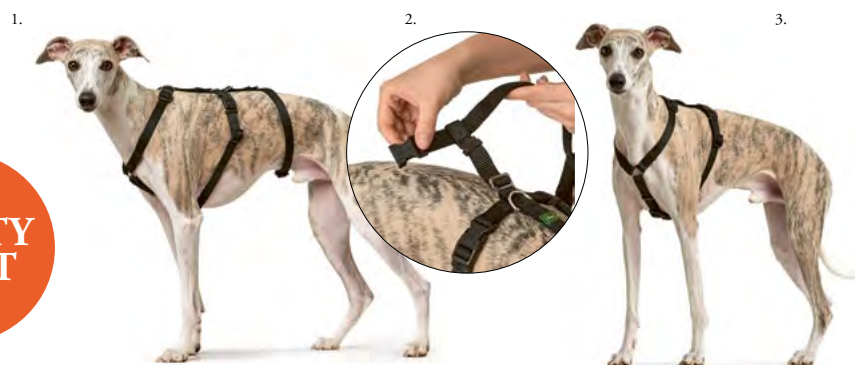

Wenn Hunde in Panik geraten und flüchten wollen, entwickeln sie sich zu wahren Ausbrecherkönigen und ziehen sich aus jedem noch so gut sitzenden Geschirr heraus. Eine gefährliche Situation, die niemand von uns erleben möchte. Deshalb haben wir für die besonders ängstlichen Hunde unser Sicherheitsgeschirr VARIO RAPID mit einem zusätzlichen Bauchgurt entwickelt, der es dem Tier nahezu unmöglich macht, das Geschirr abzustreifen. Und der Clou: Wenn Ihr vierbeiniger Freund seine Furcht überwunden hat, können Sie den 2. Bauchgurt einfach abnehmen und haben ein klassisches Geschirr.

If dogs get panicky and decide they want to bolt, they become real escape artists and can find their way out of any harness that doesn't quite fit properly - a dangerous situation which none of us want to experience. For particularly anxious dogs, we have therefore developed our VARIO RAPID safety harness with an additional stomach strap which makes it almost impossible for the dog to slip out of the harness. And here's the real trick: if your four-legged friend has overcome his fears, you can simply remove the 2nd stomach strap and you have a classic harness.



Klett
Velcro



⇒	↔*	↔.	↔
S-M	58 cm	47 – 62 cm	2,5 cm
M-L	68 cm	54 – 76 cm	3,8 cm
L	70 cm	60 – 86 cm	3,8 cm

Norwegergeschirr RANGER

Norwegian harness | Harnais norvégien | Arnés noruego | Pettorina norvegese | Norsk sele

Nylon/Fleece, sehr weich gepolstert, reflektierend, gute Verstellbarkeit und Passform | Nylon/Fleece, very soft padding, reflective, good adjustability and fit | Nylon/Polaire, rembourrage ultra souple, réfléchissant, propriétés de réglage et coupe optimales | Nylon/Vellón, acolchado muy suave, reflectante, buen ajuste y excelente adaptabilidad | Nylon/Vello, imbottitura molto morbida, riflettente, buona regolabilità e vestibilità | Nylon/Fleece, meget blødt polstret, reflekterende, god justeringsmuligheder og pasform

schwarz | black | noir | negro | nero | sort

S-M	46362		M-L	46363	
L	46385				



⇒	↔*	↔.	↔
S	32 cm	42 – 53 cm	2,0 cm
S-M	40 cm	52 – 62 cm	2,5 cm
M-L	46 cm	60 – 75 cm	2,5 cm
L	52 cm	68 – 90 cm	3,8 cm
L-XL	58 cm	82 – 105 cm	3,8 cm

Norwegergeschirr RACING

Norwegian harness | Harnais norvégien | Arnés noruego | Pettorina norvegese | Norsk sele

Nylon/Fleece, sehr weich gepolstert, reflektierend, gute Verstellbarkeit und Passform | Nylon/Fleece, very soft padding, reflective, good adjustability and fit | Nylon/Polaire, rembourrage ultra souple, réfléchissant, propriétés de réglage et coupe optimales | Nylon/Vellón, acolchado muy suave, reflectante, buen ajuste y excelente adaptabilidad | Nylon/Vello, imbottitura molto morbida, riflettente, buona regolabilità e vestibilità | Nylon/Fleece, meget blødt polstret, reflekterende, god justeringsmuligheder og pasform

rot | red | rouge | rojo | rosso | rød

S	46388		S-M	46364	
M-L	46365		L	46366	
L-XL	46389				

braun | brown | marron | marrón | marrone | brun

S	46392		S-M	46370	
M-L	46371		L	46372	
L-XL	46393				

schwarz | black | noir | negro | nero | sort

S	46396		S-M	46397	
M-L	46398		L	46399	
L-XL	46400				



+XL
3 Meter

4-fach
verstellbar
4-fold adjustable

Verstellbare Führleine EXTRA LONG

Training leash | Laisse réglable | Correa ajustable | Guinzaglio da passeggio regolabile | Justerbar line

Nylon, besonders lange Führleine, 4-fache Verstellmöglichkeit | *Nylon, extra-long leash, 4-fold adjustable* | Nylon, lanière particulièrement longue, 4 possibilités de réglage | *Nylon, correa de paseo con largo especial, 4 posibilidades de ajuste* | Nylon, guinzagli particolarmente lunghi, 4 possibilità di regolazione | *Nylon, særlig lang føresnor, 4-trins indstilling*

rot | red | rouge | rojo | rosso | rød

15/300 64954 20/300 64955

25/300 64956

braun | brown | marron | marrón | marrone | brun

15/300 64957 20/300 64958

25/300 64959

schwarz | black | noir | negro | nero | sort

15/300 64960 20/300 64961

25/300 64962

Verstellbare Führleine, doubliert

Training leash double | Laisse réglable doublé | Correa ajustable doble | Guinzaglio da passeggio regolabile doppio | Justerbar line dobbelt

Nylon doubliert, 3-fache Verstellmöglichkeit | *Nylon double, 3-fold adjustable* | Nylon doublé, 3 possibilités de réglage | *Nylon doble, 3 posibilidades de ajuste* | Nylon doppio, 3 possibilità di regolazione | *Nylon dobbelt, 3-trins indstilling*

schwarz | black | noir | negro | nero | sort

25/200 35675



EXTRA STARK
extra strong



Koppel

Coupling | Accouplement | Cercado | Sdoppiatore | Kobling

Nylon, ermöglicht das gleichzeitige Führen zweier Hunde, stufenlos längenverstellbar | *Nylon, means two dogs can be walked at the same time, length is continuously adjustable* | Nylon, permet de guider deux chiens en même temps, longueur réglable en continu | *Nylon, permite llevar a dos perros al mismo tiempo, longitud regulable de manera continua* | Nylon, consente di condurre contemporaneamente due cani, lunghezza regolabile in continuo | *Nylon, mulighed for at have to hunde i snor samtidigt, trinløs lengdejustering*

schwarz | black | noir | negro | nero | sort

S 35794 M 35834



⇒	↔	↔
S	28 – 44 cm	1,0 cm
M	40 – 63 cm	2,0 cm

Führschlaufe

Traffic leash | Poignée | Lazo de paseo | Maniglia per guinzaglio da passeggio | Håndtag

Nylon

schwarz | black | noir | negro | nero | sort

38192





NEW
colour

Führleine

Leash | Laisse | Correa | Guinzaglio da passeggio | Line

Nylon

orange | orange | orange | naranja | arancione | orange

10/110 42598  15/110 42599 

20/100 42600 

rot | red | rouge | rojo | rosso | rød

10/110 35530  15/110 35550 

20/100 35570 

petrol | teal | pétrole | petróleo | petrolio | petrol

10/110 47888  15/110 47889 

20/100 47890 

rauchblau | smoky blue | bleu fumé | azul ahumado | blu fumo |
røgfærvet blå

10/110 203347  15/110 203348 

20/100 203349 

braun | brown | marron | marrón | marrone | brun

10/110 42805  15/110 42806 

20/100 42807 

grau | grey | gris | gris | grigio | grå

10/110 47531  15/110 47532 

20/100 47533 

schwarz | black | noir | negro | nero | sort

10/110 35534  15/110 35554 

20/100 35574 





**NEW
colour**

Verstellbare Führleine

Training leash | Laisse réglable | Correa ajustable | Guinzaglio da passeggio regolabile | Justerbar line

Nylon, 3-fache Verstellmöglichkeit | *Nylon, 3-fold adjustable* | Nylon, 3 possibilités de réglage | *Nylon, 3 posibilidades de ajuste* | Nylon, 3 possibilità di regolazione | *Nylon, 3-trins indstilling*

orange | orange | orange | naranja | arancione | orange

10/200 42602  15/200 42603 

20/200 42604  25/200 42605 

rot | red | rouge | rojo | rosso | rød

10/200 41384  15/200 40545 

20/200 40359  25/200 40362 

violett | violet | violet | violeta | viola | violet

10/200 46675  15/200 46676 

20/200 46677  25/200 46678 

petrol | teal | pétrole | petróleo | petrolio | petrol

10/200 47892  15/200 47893 

20/200 47894  25/200 47895 

rauchblau | smoky blue | bleu fumé | azul ahumado | blu fumo | røgarvet blå

10/200 203350  15/200 203351 

20/200 203352  25/200 203353 

braun | brown | marron | marrón | marrone | brun

10/200 42809  15/200 42810 

20/200 42811  25/200 42812 

grau | grey | gris | gris | grigio | grå

10/200 47535  15/200 47536 

20/200 47537  25/200 47538 

schwarz | black | noir | negro | nero | sort

10/200 41385  15/200 40546 

20/200 40361  25/200 40364 



⇒	↔	↔
M	30 – 45 cm	1,5 cm
L	40 – 55 cm	2,0 cm
XL	45 – 65 cm	2,5 cm

Halsung INARI ALU-STRONG

Collar | Collier | Collar | Collare | Halsbånd

Polyester, Steckverschluss aus Aluminium, Metall-Schieber | Polyester, buckle made of aluminum, metal slide | Polyester, fermeture à clips pratique d'aluminium, coulisseau en métal | Poliéster, cierre a presión de aluminio, pasador metálico | Poliestere, chiusura a scatto in alluminio, fibbia di metallo | Polyester, klinklås af aluminium, metalspændet
beige | tan | beige | beige | beige | beige

M 69685 L 69686

XL 69687

pastellrot | pastel red | rouge pastel | rojo pastel | rosso pastello | pastelrod

M 69695 L 69696

XL 69697

lindgrün | linden green | vert pâle | verde suave | verdino chiaro | lindengrøn

M 69690 L 69691

XL 69692

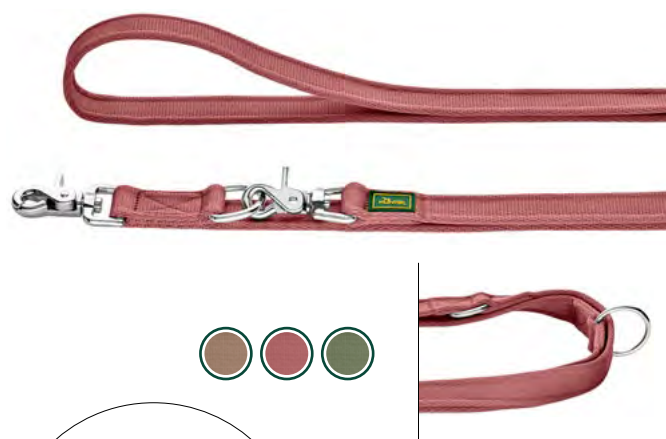

Verstellbare Führleine INARI

Training leash | Laisse réglable | Correa ajustable | Guinzaglio da passeggio regolabile | Justerbar line

Polyester, 3-fache Verstellmöglichkeit | Polyester, 3-fold adjustable | Polyester, 3 possibilités de réglage | Poliéster, 3 posibilidades de ajuste | Poliestere, possibilità di regolazione | Polyester, 3-trins indstilling

beige | tan | beige | beige | beige | beige

20/200 69688 25/200 69689

pastellrot | pastel red | rouge pastel | rojo pastel | rosso pastello | pastelrod

20/200 69698 25/200 69699

lindgrün | linden green | vert pâle | verde suave | verdino chiaro | lindengrøn

20/200 69693 25/200 69694



Passende Leinen mit smartem Scherenkarabiner.

Matching leashes with smart scissor carabiner.







⇒ XXS-XS - S

⇒ M

NEW colour

NEW colour

NEW colour



MINI

	⇒	↔	↔
XXS-XS	14 - 20 cm	1,0 cm	
XS-S	20 - 30 cm	1,0 cm	
S	25 - 35 cm	1,0 cm	
M	30 - 45 cm	1,5 cm	

Halsung TRIPOLI VARIO BASIC

Collar | Collier | Collar | Collare | Halsbånd

Nylon, besonders für Welpen und kleine Hunde geeignet, spezielle Reflektorstreifen reflektieren in Regenbogenfarben | *Nylon, suitable for puppies and young dogs, special reflective strips reflect light in the colours of the rainbow* | Nylon, convient particulièrement aux chiots et chiens de petite taille, bandes réfléchissantes spéciales aux couleurs de l'arc-en-ciel | *Nylon, adecuado sobre todo para cachorros y perros pequeños, las bandas reflectantes especiales muestran los colores del arcoíris* | Nylon, particolarmente adatto a cuccioli e cani di piccola taglia, con speciali strisce catarifrangenti che riflettono i colori dell'arcobaleno | *Nylon, især egnet til hvalpe og små hunde, særlige refleksstriber reflekterer i regnbuens farver*

gelb | yellow | jaune | amarillo | giallo | gul

XXS-XS 69210 XS-S 65535

S 65536 M 65537

orange | orange | orange | naranja | arancione | orange

XXS-XS 201920 XS-S 201921

S 201922 M 201923

hellrosa | light pink | rose clair | rosa pálido | rosa chiaro | lyserød

XXS-XS 69208 XS-S 65525

S 65526 M 65527

himbeer | raspberry | framboise | frambuesa | lampone | hindbær

XXS-XS 201944 XS-S 201945

S 201946 M 201947

hellblau | light blue | bleu clair | azul claro | azzurro | lyseblå

XXS-XS 69206 XS-S 65515

S 65516 M 65517

oliv | olive | olive | oliva | oliva | olivenfarvet

XXS-XS 201932 XS-S 201933

S 201934 M 201935

schwarz | black | noir | negro | nero | sort

XXS-XS 69212 XS-S 67114

S 67115 M 67116





Geschirr TRIPOLI

Harness | Harnais | Arnés | Pettorina | Sele

Nylon, besonders für Welpen und kleine Hunde geeignet, spezielle Reflektorstreifen reflektieren in Regenbogenfarben | *Nylon, suitable for puppies and young dogs, special reflective strips reflect light in the colours of the rainbow* | Nylon, convient particulièrement aux chiots et chiens de petite taille, bandes réfléchissantes spéciales aux couleurs de l'arc-en-ciel | *Nylon, adecuado sobre todo para cachorros y perros pequeños, las bandas reflectantes especiales muestran los colores del arcoíris* | Nylon, particolarmente adatto a cuccioli e cani di piccola taglia, con speciali strisce catarifrangenti che riflettono i colori dell'arcobaleno | *Nylon, især egnet til hvalpe og små hunde, særlige refleksstriber reflekterer i regnbuens farver*

gelb | yellow | jaune | amarillo | giallo | gul

XXS 69211 XXS-XS 65538

XS-S 65539 S 65540

orange | orange | orange | naranja | arancione | orange

XXS 201924 XXS-XS 201925

XS-S 201926 S 201927

hellrosa | light pink | rose clair | rosa pálido | rosa chiaro | lyserød

XXS 69209 XXS-XS 65528

XS-S 65529 S 65530

himbeer | raspberry | framboise | frambuesa | lampone | hindbær

XXS 201948 XXS-XS 201949

XS-S 201950 S 201951

hellblau | light blue | bleu clair | azul claro | azzurro | lyseblå

XXS 69207 XXS-XS 65518

XS-S 65519 S 65520

oliv | olive | olive | oliva | oliva | olivenfarvet

XXS 201936 XXS-XS 201937

XS-S 201938 S 201939

schwarz | black | noir | negro | nero | sort

XXS 69213 XXS-XS 67117

XS-S 67118 S 67119



	⇒	↔*	↔.	↔
MINI	XXS	14 – 20 cm	18 – 30 cm	1,0 cm
	XXS-XS	22 – 35 cm	32 – 44 cm	1,0 cm
	XS-S	24 – 36 cm	37 – 52 cm	1,0 cm
	S	33 – 46 cm	41 – 55 cm	1,5 cm

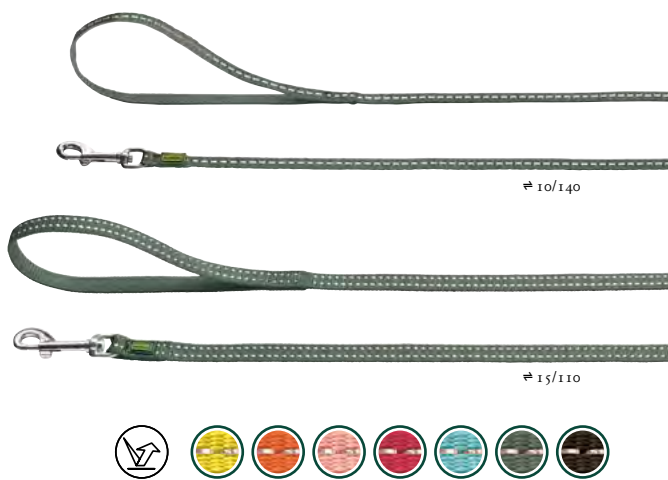

**NEW
colours**



Führleine TRIPOLI

Leash | Laisse | Correa | Guinzaglio da passeggio | Line

Nylon, besonders für Welpen und kleine Hunde geeignet, spezielle Reflektorstreifen reflektieren in Regenbogenfarben | *Nylon, suitable for puppies and young dogs, special reflective strips reflect light in the colours of the rainbow* | Nylon, convient particulièrement aux chiots et chiens de petite taille, bandes réfléchissantes spéciales aux couleurs de l'arc-en-ciel | *Nylon, adecuado sobre todo para cachorros y perros pequeños, las bandas reflectantes especiales muestran los colores del arcoíris* | Nylon, particolarmente adatto a cuccioli e cani di piccola taglia, con speciali strisce catarifrangenti che riflettono i colori dell'arcobaleno | *Nylon, især egnet til hvalpe og små hunde, særlige refleksstriber reflekterer i regnbuens farver*

gelb | yellow | jaune | amarillo | giallo | gul

10/140 69234 15/110 65542

orange | orange | orange | naranja | arancione | orange

10/140 201928 15/110 201929

hellrosa | light pink | rose clair | rosa pálido | rosa chiaro | lyserød

10/140 69235 15/110 65532

himbeer | raspberry | framboise | frambuesa | lampone | hindbær

10/140 201952 15/110 201953

hellblau | light blue | bleu clair | azul claro | azzurro | lyseblå

10/140 69233 15/110 65522

oliv | olive | olive | oliva | oliva | olivenfarvet

10/140 201940 15/110 201941

schwarz | black | noir | negro | nero | sort

10/140 69236 15/110 67121





NEW colours

XS

Verstellbare Führleine TRIPOLI

Training leash | Laisse réglable | Correa ajustable | Guinzaglio da passeggio regolabile | Justerbar line

Nylon, 3-fache Verstellmöglichkeit, besonders für Welpen und kleine Hunde geeignet, spezielle Reflektorstreifen reflektieren in Regenbogenfarben | Nylon, 3-fold adjustable, suitable for puppies and young dogs, special reflective strips reflect light in the colours of the rainbow | Nylon, 3 possibilités de réglage, convient particulièrement aux chiots et chiens de petite taille, bandes réfléchissantes spéciales aux couleurs de l'arc-en-ciel | Nylon, 3 posibilidades de ajuste, adecuado sobre todo para cachorros y perros pequeños, las bandas reflectantes especiales muestran los colores del arcoíris | Nylon, 3 possibilità di regolazione, particolarmente adatto a cuccioli e cani di piccola taglia, con speciali strisce catarifrangenti che riflettono i colori dell'arcobaleno | Nylon, 3-trins indstilling, især egnet til hvalpe og små hunde, særlige refleksstriber reflekterer i regnbuens farver

gelb | yellow | jaune | amarillo | giallo | gul
10/200 65543 15/200 65544
orange | orange | orange | naranja | arancione | orange

10/200 201930 15/200 201931
hellrosa | light pink | rose clair | rosa pálido | rosa chiaro | lyserød

10/200 65533 15/200 65534
himbeer | raspberry | framboise | frambuesa | lampone | hindbær

10/200 201954 15/200 201955
hellblau | light blue | bleu clair | azul claro | azzurro | lyseblå

10/200 65523 15/200 65524
oliv | olive | olive | oliva | oliva | olivenfarvet

10/200 201942 15/200 201943
schwarz | black | noir | negro | nero | sort

10/200 67122 15/200 67123





⇒	⇔	↔
S	22 – 35 cm	1,0 cm
M	30 – 45 cm	1,5 cm
M-L	35 – 53 cm	2,0 cm
XL	41 – 63 cm	2,5 cm

Halsung ECCO SPORT VARIO BASIC

Collar | Collier | Collar | Collare | Halsbånd

Nylon

rot | red | rouge | rojo | rosso | rød

S 91618 M 91624

M-L 91630 XL 91636

schwarz | black | noir | negro | nero | sort

S 91621 M 91627

M-L 91633 XL 91639



⇒	⇔*	⇔*	↔
XXS	23 – 35 cm	25 – 41 cm	1,0 cm
XXS-XS	30 – 45 cm	33 – 54 cm	1,5 cm
S-M	42 – 65 cm	48 – 70 cm	2,0 cm
M-L	54 – 87 cm	59 – 100 cm	2,5 cm

Geschirr ECCO SPORT VARIO RAPID

Harness | Harnais | Arnés | Pettorina | Sele

Nylon, 4-fache Verstellmöglichkeit | Nylon, 4-fold adjustable | Nylon, 4 possibilités de réglage | Nylon, 4 posibilidades de ajuste | Nylon, 4 possibilità di regolazione | Nylon, 4-trins indstilling

rot | red | rouge | rojo | rosso | rød

XXS 91024 XXS-XS 91030

S-M 91036 M-L 91042

schwarz | black | noir | negro | nero | sort

XXS 91027 S-M 91039

M-L 91045





Führleine ECCO SPORT

Leash | Laisse | Correa | Guinzaglio da passeggio | Line

Nylon

rot | red | rouge | rojo | rosso | rød

15/110 91090 

schwarz | black | noir | negro | nero | sort

15/110 91093 



Verstellbare Führleine ECCO SPORT

Training leash | Laisse réglable | Correa ajustable | Guinzaglio da passeggio regolabile | Justerbar line

Nylon, 3-fache Verstellmöglichkeit | *Nylon, 3-fold adjustable* | Nylon, 3 possibilités de réglage | *Nylon, 3 posibilidades de ajuste* | Nylon, 3 possibilità di regolazione | *Nylon, 3-trins indstilling*

rot | red | rouge | rojo | rosso | rød

15/200 91108 

schwarz | black | noir | negro | nero | sort

15/200 91111 





Größe M mit Sicherheitsverschluss

size M with safety lock

⇔ XXS-XS/1 - S

⇔ M

MINI

⇔	↔	↔
XXS-XS/1	14 – 20 cm	1,0 cm
XXS-XS/2	17 – 24 cm	1,0 cm
S	24 – 36 cm	1,0 cm
M	30 – 46 cm	1,5 cm

Halsung LONDON VARIO BASIC

Collar | Collier | Collar | Collare | Halsbånd

Polyester, mit Sicherheitsverschluss (⇔ M) | Polyester, with safety click (⇔ M) | Polyester, avec fermeture de sécurité (⇔ M) | Poliéster, cierre de seguridad (⇔ M) | Poliestere, con chiusura di sicurezza (⇔ M) | Polyester, med sikkerhedslås (⇔ M)

orange | orange | orange | naranja | arancione | orange

XXS-XS/1 69178 XXS-XS/2 67991

S 67992 M 67993

rot | red | rouge | rojo | rosso | rød

XXS-XS/1 69194 XXS-XS/2 68091

S 68092 M 68093

hellblau | light blue | bleu clair | azul claro | azzurro | lyseblå

XXS-XS/1 69174 XXS-XS/2 67966

S 67967 M 67968

dunkelblau | dark blue | bleu foncé | azul oscuro | blu scuro | mørkeblå

XXS-XS/1 69170 XXS-XS/2 67941

S 67942 M 67943

limette | lime | citron vert | limón | limetta | limone

XXS-XS/1 69186 XXS-XS/2 68041

S 68042 M 68043

oliv | olive | olive | oliva | oliva | olivenfarvet

XXS-XS/1 69182 XXS-XS/2 68016

S 68017 M 68018

braun | brown | marron | marrón | marrone | brun

XXS-XS/1 69198 XXS-XS/2 68116

S 68117 M 68118

anthrazit | anthracite | anthracite | anthracita | anthracite | antracit

XXS-XS/1 69190 XXS-XS/2 68066

S 68067 M 68068

schwarz | black | noir | negro | nero | sort

XXS-XS/1 69202 XXS-XS/2 68141

S 68142 M 68143





↗	↔	↔
L	34 – 56 cm	2,0 cm
L-XL	39 – 64 cm	2,5 cm

Halsung LONDON VARIO PLUS

Collar | Collier | Collar | Collare | Halsbånd

Polyester, mit Sicherheitsverschluss, mit Zugentlastung | Polyester, with safety click, with pull-relief | Polyester, avec fermeture de sécurité, avec soulagement de traction | Poliéster, cierre de seguridad, con antitirones | Poliestere, con chiusura di sicurezza, con antistrappo | Polyester, med sikkerhedslås, med trækafastning

orange | orange | orange | naranja | arancione | orange

L 67994  L-XL 67995 



rot | red | rouge | rojo | rosso | rød

L 68094  L-XL 68095 



hellblau | light blue | bleu clair | azul claro | azzurro | lyseblå

L 67969  L-XL 67970 

dunkelblau | dark blue | bleu foncé | azul oscuro | blu scuro | mørkeblå

L 67944  L-XL 67945 

limette | lime | citron vert | limón | limetta | limone

L 68044  L-XL 68045 

oliv | olive | olive | oliva | oliva | olivenfarvet

L 68019  L-XL 68020 

braun | brown | marron | marrón | marrone | brun

L 68119  L-XL 68120 

anthrazit | anthracite | anthracite | anthracita | anthracite | antracit

L 68069  L-XL 68070 

schwarz | black | noir | negro | nero | sort

L 68144  L-XL 68145 

ZUG-
ENTLASTUNG
with pull-relief



Mit Sicherheitsverschluss

With safety click



Größen XXS-XS bis M mit Sicherheitsverschluss

Sizes XXS-XS to M with safety lock



	⇒	↔*	↔.	↔
MINI	XXS/1	14 – 20 cm	18 – 30 cm	1,0 cm
	XXS/2	16 – 25 cm	22 – 36 cm	1,0 cm
	XXS/3	23 – 35 cm	25 – 42 cm	1,0 cm
	XXS-XS	30 – 45 cm	32 – 52 cm	1,5 cm
	S	38 – 59 cm	41 – 70 cm	2,0 cm
	M	53 – 85 cm	58 – 101 cm	2,5 cm

Geschirr LONDON VARIO RAPID

Harness | Harnais | Arnés | Pettorina | Sele

Polyester, mit Sicherheitsverschluss (b XXS-XS – M), mit Zugentlastung | Polyester, with safety click (b XXS-XS – M), with pull-relief | Polyester, avec fermeture de sécurité (b XXS-XS – M), avec soulagement de traction | Poliéster, cierre de seguridad (b XXS-XS – M), con antitirones | Poliestere, con chiusura di sicurezza (b XXS-XS – M), con antistrappo | Polyester, med sikkerhedslås (b XXS-XS – M), med trækafastning

orange | orange | orange | naranja | arancione | orange

XXS/1	69179	XXS/2	67996
XXS/3	67997	XXS-XS	67998
S	67999	M	68000

rot | red | rouge | rojo | rosso | rød

XXS/1	69195	XXS/2	68096
XXS/3	68097	XXS-XS	68098
S	68099	M	68100

hellblau | light blue | bleu clair | azul claro | azzurro | lyseblå

XXS/1	69175	XXS/2	67971
XXS/3	67972	XXS-XS	67973
S	67974	M	67975

dunkelblau | dark blue | bleu foncé | azul oscuro | blu scuro | mørkeblå

XXS/1	69171	XXS/2	67946
XXS/3	67947	XXS-XS	67948
S	67949	M	67950

limette | lime | citron vert | limón | limetta | limone

XXS/1	69187	XXS/1	68046
XXS/3	68047	XXS-XS	68048
S	68049	M	68050

oliv | olive | olive | oliva | oliva | olivenfarvet

XXS/1	69183	XXS/2	68021
XXS/3	68022	XXS-XS	68023
S	68024	M	68025

braun | brown | marron | marrón | marrone | brun

XXS/1	69199	XXS/2	68121
XXS/3	68122	XXS-XS	68123
S	68124	M	68125

anthrazit | anthracite | anthracite | anthracita | anthracite | antracit

XXS/1	69191	XXS/2	68071
XXS/3	68072	XXS-XS	68073
S	68074	M	68075

schwarz | black | noir | negro | nero | sort

XXS/1	69203	XXS/2	68146
XXS/2	68147	XXS-XS	68148
S	68149	M	68150

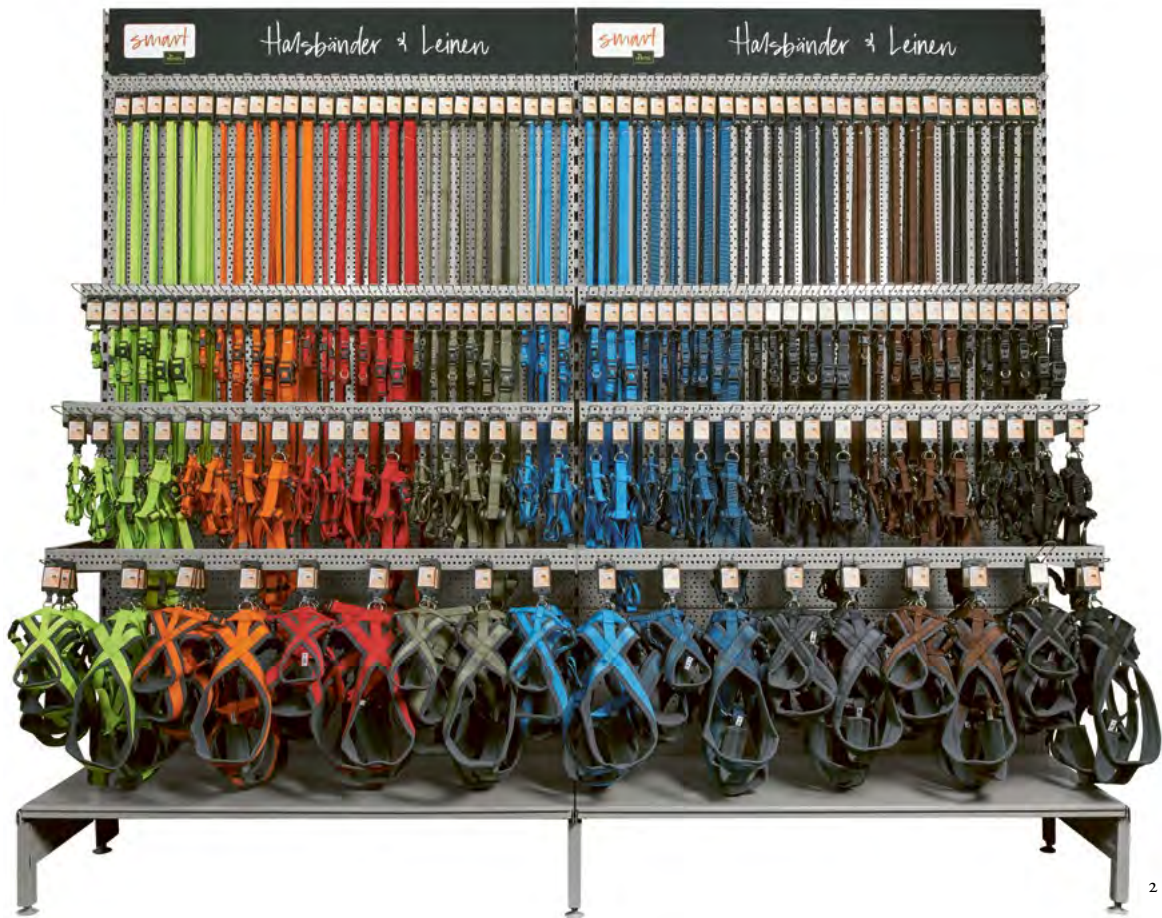

2 X 1,25 m



1,25 m

London

Die Serie LONDON überzeugt durch ihre bunte Farbpalette, ihre pflegeleichte Robustheit und ihr großartiges Preis-Leistungs-Verhältnis. Hier finden Sie Basic-Teile für jeden Tag, die absolut zu begeistern wissen.

The new LONDON range will win you over with its bright colours. It is easy to clean, robust and offers great value for money – essentials for everyday use that are sure to impress.



Geschirr LONDON COMFORT

Harness | Harnais | Arnés | Pettorina | Sele

Polyester/3D-Mesh-Material, sehr weich gepolstert, mit Sicherheitsverschluss, 2-fache Verstellmöglichkeit (Bauch) | Polyester/3D mesh material, very soft padding, with safety clasp, 2-fold adjustable (belly) | Polyester/matériau mesh 3D, rembourrage ultra souple, avec fermoir de sécurité, 2 possibilités de réglage (ventre) | Poliéster/Materiale mesh 3D, acolchado muy suave, con cierre de seguridad, 2 posibilidades de ajuste (abdomen) | Poliestere/material de malla 3D, imbottitura molto morbida, con chiusura di sicurezza, 2 possibilità di regolazione (ventre) | Polyester/3D-mesh-materiale, meget blødt polstret, med sikkerhedslukke, 2-trins indstilling (bug)



↔	↔	↔	↔
XS-S	28 cm	39 – 47 cm	1,5 cm
S-M/1	40 cm	48 – 56 cm	2,5 cm
S-M/2	49 cm	52 – 62 cm	2,5 cm
M	55 cm	57 – 70 cm	2,5 cm
M-L	61 cm	63 – 82 cm	2,5 cm
L/1	64 cm	68 – 91 cm	2,5 cm
L/2	71 cm	73 – 100 cm	2,5 cm



orange | orange | orange | naranja | arancione | orange

XS-S	68009		S-M/1	68010
S-M/2	68011		M	68012
M-L	68013		L/1	68014
L/2	68015			

rot | red | rouge | rojo | rosso | rød

XS-S	68109		S-M/1	68110
S-M/2	68111		M	68112
M-L	68113		L/1	68114
L/2	68115			

hellblau | light blue | bleu clair | azul claro | azzurro | lyseblå

XS-S	67984		S-M/1	67985
S-M/2	67986		M	67987
M-L	67988		L/1	67989
L/2	67990			

dunkelblau | dark blue | bleu foncé | azul oscuro | blu scuro | mørkeblå

XS-S	67959		S-M/1	67960
S-M/2	67961		M	67962
M-L	67963		L/1	67964
L/2	67965			

limette | lime | citron vert | limón | limetta | limone

XS-S	68059		S-M/1	68060
S-M/2	68061		M	68062
M-L	68063		L/1	68064
L/2	68065			



Mit Sicherheitsverschluss
with safety clasp

oliv | olive | olive | oliva | oliva | olivenfarvet

XS-S	68034		S-M/1	68035	
S-M/2	68036		M	68037	
M-L	68038		L/1	68039	
L/2	68040				

braun | brown | marron | marrón | marrone | brun

XS-S	68134		S-M/1	68135	
S-M/2	68136		M	68137	
M-L	68138		L/1	68139	
L/2	68140				

anthrazit | anthracite | anthracite | anthracita | anthracite | antracit

XS-S	68084		S-M/1	68085	
S-M/2	68086		M	68087	
M-L	68088		L/1	68089	
L/2	68090				

schwarz | black | noir | negro | nero | sort

XS-S	68159		S-M/1	68160	
S-M/2	68161		M	68162	
M-L	68163		L/1	68164	
L/2	68165				

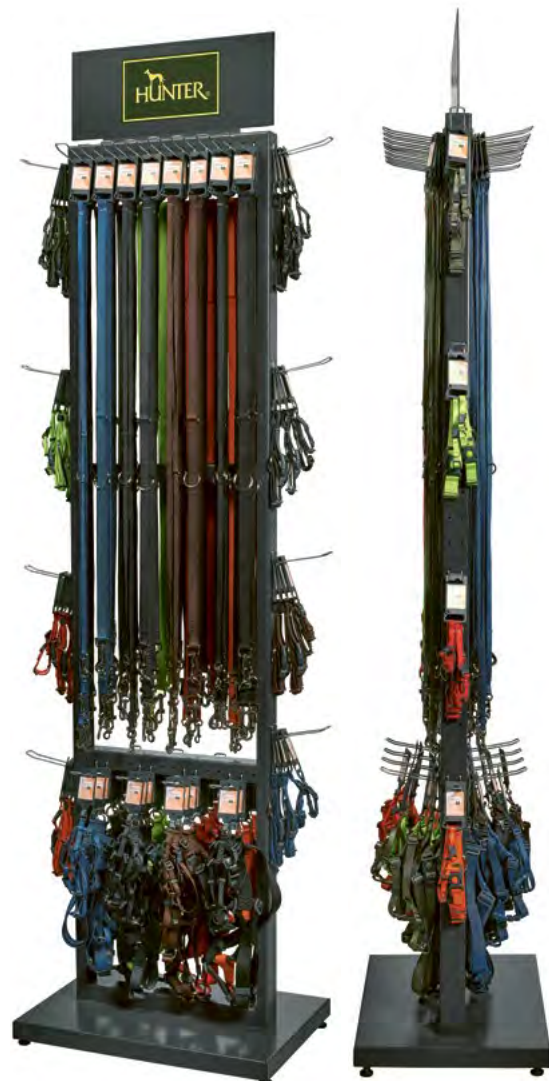

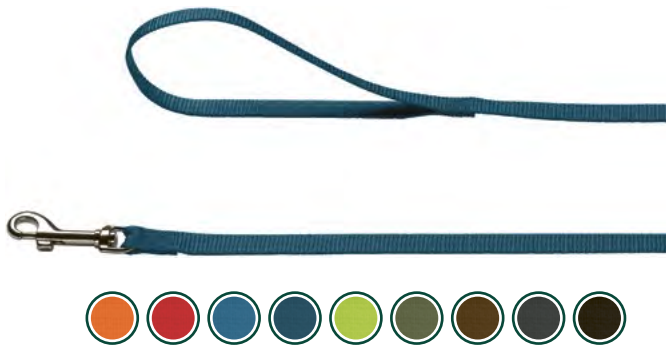

Führleine LONDON

Leash | Laisse | Correa | Guinzaglio da passeggio | Line

Polyester | Polyester | Polyester | Poliéster | Poliestere | Polyester

orange | orange | orange | naranja | arancione | orange

10/140 69180 15/110 68002

20/100 68003 25/100 68004

rot | red | rouge | rojo | rosso | rød

10/140 69196 15/110 68102

20/100 68103 25/100 68104

hellblau | light blue | bleu clair | azul claro | azzurro | lyseblå

10/140 69176 15/110 67977

20/100 67978 25/100 67979

dunkelblau | dark blue | bleu foncé | azul oscuro | blu scuro | mørkeblå

10/140 69172 15/110 67952

20/100 67953 25/100 67954

limette | lime | citron vert | limón | limetta | limone

10/140 69188 15/110 68052

20/100 68053 25/100 68054

oliv | olive | olive | oliva | oliva | olivenfarvet

10/140 69184 15/110 68027

20/100 68028 25/100 68029

braun | brown | marron | marrón | marrone | brun

10/140 69200 15/110 68127

20/100 68128 25/100 68129

anthrazit | anthracite | anthracite | anthracita | anthracite | antracit

10/140 69192 15/110 68077

20/100 68078 25/100 68079

schwarz | black | noir | negro | nero | sort

10/140 69204 15/110 68152

20/100 68153 25/100 68154





Verstellbare Führleine LONDON

Training leash | Laisse réglable | Correa ajustable | Guinzaglio da passeggio regolabile | Justerbar line

Polyester, 3-fache Verstellmöglichkeit | Polyester, 3-fold adjustable | Polyester, 3 possibilità di regolage | Poliéster, 3 posibilidades de ajuste | Poliestere, 3 possibilità di regolazione | Polyester, 3-trins indstilling
orange | orange | orange | naranja | arancione | orange

10/200 69181 15/200 68006

20/200 68007 25/200 68008

rot | red | rouge | rojo | rosso | rød

10/200 69197 15/200 68106

20/200 68107 25/200 68108

hellblau | light blue | bleu clair | azul claro | azzurro | lyseblå

10/200 69177 15/200 67981

20/200 67982 25/200 67983

dunkelblau | dark blue | bleu foncé | azul oscuro | blu scuro | mørkeblå

10/200 69173 15/200 67956

20/200 67957 25/200 67958

limette | lime | citron vert | limón | limetta | limone

10/200 69189 15/200 68056

20/200 68057 25/200 68058

oliv | olive | olive | oliva | oliva | olivenfarvet

10/200 69185 15/200 68031

20/200 68032 25/200 68033

braun | brown | marron | marrón | marrone | brun

10/200 69201 15/200 68131

20/200 68132 25/200 68133

anthrazit | anthracite | anthracite | anthracita | anthracite | antracit

10/200 69193 15/200 68081

20/200 68082 25/200 68083

schwarz | black | noir | negro | nero | sort

10/200 69205 15/200 68156

20/200 68157 25/200 68158



Suchleine LONDON

Tracking leash | Laisse de promenade | Correa de rastreo | Guinzaglio da ricerca | Sogeline

Polyester, reflektierend, mit Handschlaufe | Polyester, reflecting, with handloop | Polyester, réfléchissant, avec poignée | Poliéster, reflectante, con lazo de mano | Poliestere, riflettente, con maniglia | Polyester, refleks, med håndtag

schwarz | black | noir | negro | nero | sort

20/500 68166 20/1000 68167

20/2000 68168



Outdoor, Hundesport & Ausbildung

— *Outdoor, Sport & Training* —

HUNTER bietet speziell für Hundesport und Ausbildung eine einzigartige Auswahl an. Die Produkte zeichnen sich durch ihre lange Lebensdauer aus, auch bei starker Beanspruchung. Sie sind daher für den sportlichen Gebrauch im Freien, ebenso wie für die Hundeausbildung und den Alltag absolut zu empfehlen. Die hochwertigen Materialien und die erstklassige Verarbeitung der Produkte garantieren jahrelange Freude mit dem HUNTER-Produkt Ihrer Wahl!

HUNTER now has a unique range especially for dog sport activities and training. The products are characterised by their long lifetime, even under lots of strain. They are therefore highly recommended for outdoor sports use as well as for training and every day use. The high quality materials and the first class workmanship of the products guarantee you years of happiness with the HUNTER product of your choice!



Vorführleine

Show leash | Corde de présentation | Correa de exhibición | Guinzaglio da esposizione | Udstillingsline

Kernlederrundschnur, stufenlos verstellbare Halsschleife | Round leather, individually adjustable neck loop | Corde ronde en cuir sellier, collier réglable en continu | Correa de cuero, regulable en continuo correa para el cuello | Corda in cuoio di prima qualità, ampiezza collare regolabile in continuo | Kernelederline, trinløst regulerbart halsbånd

natur | tan | nature | natural | naturale | natur

4/140 19730

schwarz | black | noir | negro | nero | sort

4/140 19725

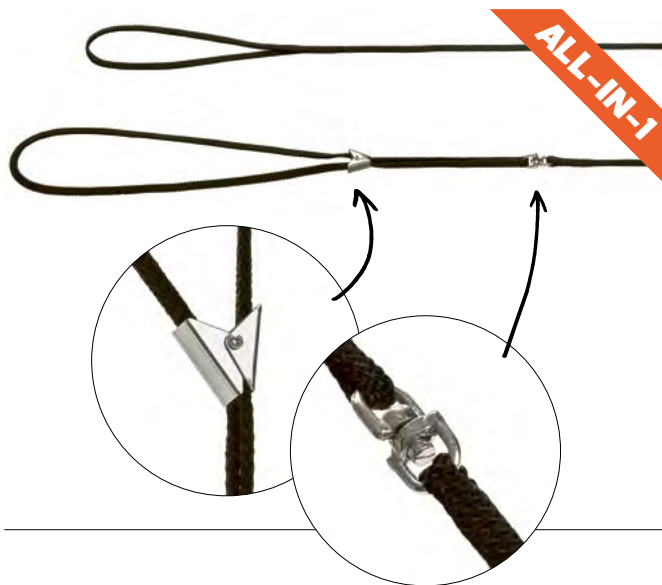

Vorführleine mit integrierter Halsung

Show leash with integrated collar | Corde de présentation avec collier intégrée | Correa de exhibición con collar incluida | Guinzaglio da esposizione con collare integrato | Udstillingsline med integreret halsbånd

Nylon

schwarz | black | noir | negro | nero | sort

5/120 98577



Suchleine SOLID EDUCATION

Tracking leash | Laisse de promenade | Correa de rastreo | Guinzaglio da ricerca | Søgeline

Rindsleder, abgerundete Kanten, Bolzenhaken eingeflochten, besonders geeignet zum Einsatz bei der Ausbildung und im Hundesport | Cow leather, rounded edges, woven bolt hooks, particularly suitable for training and in dog sports | Cuir de bœuf, bords arrondis, mousquetons tressés, convient particulièrement bien pour le dressage et les sports canins | Cuero de vacuno, bordi arrotondati, ganci con bulloni, particolarmente adatto per l'uso in addestramento e nello sport per cani | Cuoio di bovina, cantos redondeados, gancho intercalado, especialmente adecuado para enseñar y hacer deporte con el perro | Okseleder, afrundede kanter, indvævet karabinhage, særlig godt egnet til uddannelse og i hundesport

schwarz | black | noir | negro | nero | sort

11/500 66099 18/500 66100



Kurzführer VISBY SUPER GRIP

Short leash | *Laisse courte* | *Guía breve* | *Guinzaglio corto* | *Kort line*

sehr griffige Leine, perfekt zum Trainieren, schwimmfähig | *extremely non-slip leash, perfectly suited to training, floating* | Laisse ultra-maniable, parfaite pour l'entraînement de votre chien, flottable | *Correa muy manejable, perfecta para realizar entrenamientos, flotable* | Guinzaglio con una presa molto salda, perfettamente adatto all'addestramento, galleggiante | *line der giver fast greb, perfekt til træning, kan holde sig flydende*

gelb | yellow | jaune | amarillo | giallo | gul

20/50 65880 

orange | orange | orange | naranja | arancione | orange

20/50 65876 



Führleine VISBY SUPER GRIP

Leash | *Laisse* | *Correa* | *Guinzaglio da passeggio* | *Line*

sehr griffige Leine, perfekt zum Trainieren, schwimmfähig | *extremely non-slip leash, perfectly suited to training, floating* | Laisse ultra-maniable, parfaite pour l'entraînement de votre chien, flottable | *Correa muy manejable, perfecta para realizar entrenamientos, flotable* | Guinzaglio con una presa molto salda, perfettamente adatto all'addestramento, galleggiante | *line der giver fast greb, perfekt til træning, kan holde sig flydende*

gelb | yellow | jaune | amarillo | giallo | gul

20/120 65881 

orange | orange | orange | naranja | arancione | orange

20/120 65877 



Suchleine VISBY SUPER GRIP

Tracking leash | *Laisse de promenade* | *Correa de rastreo* | *Guinzaglio da ricerca* | *Sogeline*

sehr griffige Leine, perfekt zum Trainieren, schwimmfähig | *extremely non-slip leash, perfectly suited to training, floating* | Laisse ultra-maniable, parfaite pour l'entraînement de votre chien, flottable | *Correa muy manejable, perfecta para realizar entrenamientos, flotable* | Guinzaglio con una presa molto salda, perfettamente adatto all'addestramento, galleggiante | *line der giver fast greb, perfekt til træning, kan holde sig flydende*

gelb | yellow | jaune | amarillo | giallo | gul

20/500 65882  20/1000 65883 

orange | orange | orange | naranja | arancione | orange

20/500 65878  20/1000 65879 



Suchleine CONVENIENCE

Tracking leash | Laisse de promenade | Correa de rastreo | Guinzaglio da ricerca | Sogeline

reißfestes, pflegeleichtes Material, besonders geeignet zum Einsatz bei der Jagd und im Hundesport (z.B. Mantrailing), ohne Handschlaufe | *tear-resistant, easy-care materials, especially suitable for use in hunting and dog sports (e.g. mantrailing), without wrist strap* | matériau résistant à la déchirure et facile d'entretien, convient particulièrement pour les activités de chasse et les sports (le mantrailing, par exemple), sans dragonne | *material resistente y fácil de limpiar, especialmente adecuado para su utilización durante la caza o en deportes caninos (p. ej. en mantrailing), sin correa para la mano* | resistente agli strappi, materiale facile da pulire, particolarmente adatto per l'uso nella caccia e negli sport per cani (ad es. mantrailing), senza cinghia | *træksterkt, plejelet materiale, særlig egnet til indsats ved jagt og i hundesport (f.eks. mantrailing), uden håndstrop*

neonorange | neon orange | orange fluo | naranja fosforescente | arancione fluo | neonorange

10/500 69872  10/1200 69875 

15/500 69873  15/1200 69876 

20/500 69874  20/1200 69877 

himbeer | raspberry | framboise | frambuesa | lampone | hindbær

10/500 69866  10/1200 69869 

15/500 69867  15/1200 69870 

20/500 69868  20/1200 69871 

türkis | turquoise | turquoise | turquesa | turchese | turkis

10/500 69884  10/1200 69887 

15/500 69885  15/1200 69888 

20/500 69886  20/1200 69889 

apfelgrün | apple green | pomme verte | verde manzana | verde mela | æblegrøn

10/500 69860  10/1200 69863 

15/500 69861  15/1200 69864 

20/500 69862  20/1200 69865 

dunkelgrün | dark green | vert foncé | verde oscuro | verde scuro | mørkegrøn

10/500 69890  10/1200 69893 

15/500 69891  15/1200 69894 

20/500 69892  20/1200 69895 

schwarz | black | noir | negro | nero | sort

10/500 69878  10/1200 69881 

15/500 69879  15/1200 69882 

20/500 69880  20/1200 69883 

Langlebig, reißfest und witterungsbeständige sowie griffig bei Wärme und Kälte gleichermaßen ist unsere Schleppeine der ideale Begleiter für alle Wetterbedingungen und bietet maximalen Komfort und Sicherheit.

Durable, tear-resistant and weatherproof as well as grippy in warmth and cold alike, our drag leash is the ideal companion for all weather conditions and offers maximum comfort and safety.



Feldleine

Tracking leash | *Laisse de promenade* | *Correa de campo* | *Lunghina* | *Sporeline*

Polyamidseil, mit Handschlaufe, ideal zur Verwendung mit einem Geschirr | *Polyamid rope, with handloop, ideal for use with a harness* | Corde en polyamide, avec poignée, idéal pour l'utilisation avec un harnais | *Cuerda de poliamida, con lazo de mano, perfecto para usarlo con un arnés* | Corda in poliammide, con maniglia, ideale per l'utilizzo con una pettorina | *Polyamidline, med håndtag, ideale per l'utilizzo con una pettorina*

grün | green | vert | verde | verde | grøn

8/400 22990  8/1000 22995 

8/2000 23000 

schwarz | black | noir | negro | nero | sort

8/400 41033  8/1000 41034 

8/2000 41035 



Suchleine LONDON

Tracking leash | *Laisse de promenade* | *Correa de rastreo* | *Guinzaglio da ricerca* | *Søgeline*

Polyester, reflektierend, mit Handschlaufe | *Polyester, reflecting, with handloop* | Polyester, réfléchissant, avec poignée | *Poliéster, reflectante, con lazo de mano* | Poliestere, riflettente, con maniglia | *Polyester, refleks, med håndtag*

schwarz | black | noir | negro | nero | sort

20/500 68166  20/1000 68167 

20/2000 68168 





Ruckdämpfer

Tug absorber | Amortisseur de secousses | Amortiguador de tirones | Ammortizzatore | Rykdæmper

vermindert den plötzlichen Zug beim Loslaufen des Hundes, strapazierfähiges und elastisches Material, mit Lederkappen, Adapter zwischen Halsband und Leine | *reduces jerking and pulling when the dog lunges or jumps, strong and elastic material, with leather end covers, adapter between collar and leash* | *diminue la traction soudaine lorsque le chien saute, anti-usure et élastique, adaptateur entre le collier et la laisse* | *evita el tirón repentino cuando el perro salta, resistente y elástico, adaptador entre el collar y la correa* | *ammortizza un improvviso strattone del cane quando inizia a correre, in materiale elastico e resistente, con estremità in pelle, adattatore tra collare e guinzaglio* | *nedsætter pludselige ryk, når hunden begynder at løbe, robust og elastisk materiale, med lederbeslag, adapter mellem Halsbånd og line*

schwarz | black | noir | negro | nero | sort

25/45 40210 

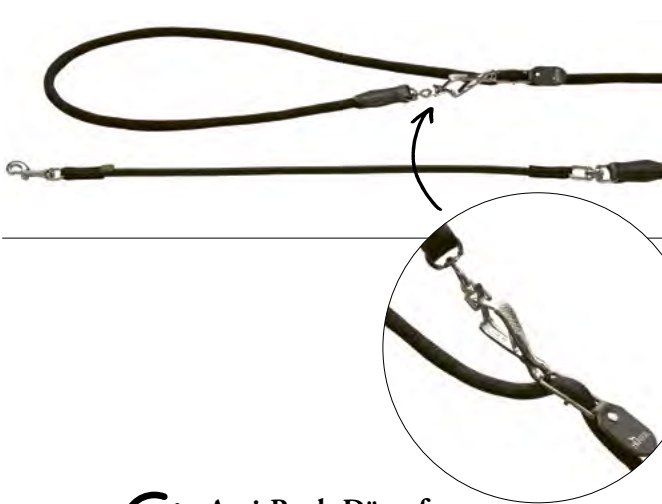

Fahrrad- & Joggingleine

Bicycle & jogging leash | Laisse pour jogging & cyclisme | Correa para bicicleta & para correr | Guinzaglio per bicicletta & jogging | Cykel- & joggingline

Die Fahrrad- & Joggingleine zeichnet sich durch ihre variable und sichere Handhabung aus. Ein elastischer Zug am Ende der Leine verhindert unangenehmes Rucken an Halsband und Handgelenk. Sollten Sie einmal in eine kritische Situation geraten, so können Sie sich dank des funktionellen Zangenhakens blitzschnell von Ihrem Hund lösen. | *The bicycle & jogging leash is distinguished by its flexibility, and is also safe and easy to use. An elastic lanyard at the end of the leash reduces uncomfortable tugging and pulling on collar and wrist alike. If you should happen to find yourself in a critical situation, you can free yourself at once from your dog thanks to the quick-release double snap closure.* | *La laisse pour jogging & cyclisme est caractérisée par sa flexibilité, sa sûreté et sa facilité d'emploi. Une boucle élastique située à l'extrémité de la laisse réduit les à-coups désagréables au collier et au poignet. Si vous vous trouvez soudainement dans une situation difficile, vous pouvez alors vous détacher très rapidement de votre chien grâce au mousqueton à déclenchement rapide.* | *La correa para bicicleta & para correr se distingue por su flexibilidad y también muy segura y fáciles de usar. Un cordón elástico situado al final de las cuerdas reduce los molestos estirones y efectos de tracción sobre el collar y, como consecuencia, para la muñeca. Antes de que todo esto suceda y se vea expuesto a una situación un tanto crítica, usted puede soltar al instante su perro gracias a nuestro doble cierre de apertura rápida.* | *Il guinzaglio per bicicletta & jogging si caratterizza per il suo uso versatile e sicuro. Una fettuccia elastica alla sua estremità impedisce i fastidiosi strattoni al collare e al polso. Se dovete trovarvi in una situazione critica, potete sganciare il vostro cane in modo estremamente rapido grazie al funzionale moschettone a pinza.* | *Cykel & joggingline udmærker sig ved at være variabel og sikker at håndtere. Et elastisk træk i enden af linen forhindrer ubehagelige ryk i Halsbånd og håndled. I en kritisk situation kan du lynhurtigt løse hunden med den funktionelle karabinhage.*

schwarz | black | noir | negro | nero | sort

10/270 39998 



Anti-Ruck-Dämpfer

Anti-slip damper



Schnellverschluss - Zangenhaken

Quick-release fastener - pincer hook



Variable Längeneinstellung

bis max 2,70 m

*Variable length adjustment
up to max. 2.70 m*



Silikon Snackbeutel LUGO

Silicone snack bag | Sac de récompense en silicone | Bolsillo de silicona de recompensa | Borsa in silicone per spuntini | Snack taske i silikon

Silikon, ideal geeignet zur Aufbewahrung von Belohnungen, mit Magnetverschluss, zum Befestigen an einem Gürtel, pflegeleicht und spülmaschinengeeignet | Silicon, ideal for storing treats, with magnetic lock, for attaching to a belt, easy to clean and dishwasher safe | Silicone, idéal pour le rangement de récompenses, avec fermeture magnétique, pour fixer à une ceinture, facile d'entretien et lavable au lave-vaisselle | Silicona, ideal para guardar premios, con cierre magnético, puede sujetarse en el cinturón, fácil de limpiar y apto para el lavavajillas | Silicone, perfetto per conservare la paga, con chiusura magnetica, da fissare a una cintura, facile da pulire e lavabile in lavastoviglie | Silikone, velegnet til opbevaring af godbidder, med magnetlukning, til fastgørelse på bælte, let at rengøre og tåler opvaskemaskine

beige | tan | beige | beige | beige | beige

S 65133

rot | red | rouge | rojo | rosso | rød

S 65132

anthrazit | anthracite | anthracite | anthracita | anthracite | antracit

S 66305 M 67132



FC BAYERN MÜNCHEN

BVB

S 68577

FC Bayern München

S 69241



SANSIBAR MORSUM

blau/beige | blue/tan | bleu/beige | azul/beige | blu/beige | blå/beige

S 69011 M 69012

grau/beige | grey/tan | gris/beige | gris/beige | grigio/beige | grå/beige

S 69013 M 69014



Sie können ihn einfach einhändig öffnen, hineingreifen und die begehrten Hundesnacks hervorzubringen. Sie müssen den Snackbeutel aber nicht schließen – das passiert wie von selbst, dank des Magnetverschlusses.

The particular highlight of the LUGO silicone snack bag is that you can open, reach in and conjure up your dog's treasured treat all with just one hand. There's no need to close the silicone snack bag - that happens automatically thanks to the magnetic lock.

Ein Handgriff
One handgrip



⇒	■	
S	13 x 11 x 5 cm	2 Stck. pcs.
M	14 x 15 x 7 cm	2 Stck. pcs.



3DSoft
Comfort
Material

Snackbeutel HILO BASIC

Snack bag | Sac de récompense | Bolsa de recompensa | Borse per spuntini | Snack taske

Polyester/3D-Mesh-Material, zum Befestigen an einem Gürtel (mit Clip), ideal zur Aufbewahrung von Snacks, mit Hilfe einer Kordel verschließbar, auswaschbar | Polyester/3D mesh material, to attach to a belt (with clip), ideal for storing rewards, can be opened and closed with the help of a cord, washable | Polyester / Matériau mesh 3D, à fixer à la ceinture (avec clip), idéal pour ranger les friandises, se ferme avec un cordon, lavable | Poliéster/Materiale mesh 3D, para fijar al cinturón (con clip), ideal para guardar snacks, con cordón de cierre, puede limpiarse en húmedo | Poliestere/Material de malla 3D, per il fissaggio a una cintura (con clip), ideale per riporre gli snack, può essere chiuso con una corda, lavabile | Polyester/3D-mesh-materiale, til fastgørelse til et bælte (med klemme), ideel til opbevaring af snacks, ved hjælp af en snor kan det lases, kan vaskes

orange | orange | orange | naranja | arancione | orange

67396

rot | red | rouge | rojo | rosso | rød

67393

limette | lime | citron vert | limón | limetta | limone

67394

blau | blue | bleu | azul | blu | blå

67533

türkis | turquoise | turquoise | turquesa | turchese | turkis

67398

braun | brown | marron | marrón | marrone | brun

67397

anthrazit | anthracite | anthracite | anthracita | anthracite | antracit

67395

BVB

68594

FC Bayern München

69258



14 x 10 x 8 cm



3 Stck. | pcs.



■ 14 x 8 x 8 cm 3 Stck. | pcs.

Snackbeutel BUGRINO BASIC

Snack bag | Sac de récompense | Bolsa de recompensa | Borse per spuntini | Snack taske

zum Befestigen an einem Gürtel (mit Clip), ideal zur Aufbewahrung von Snacks, mit Hilfe einer Kordel verschließbar, robustes Material, auswaschbar | to attach to a belt (with clip), ideal for storing rewards, can be opened and closed with the help of a cord, tough material, washable | à attacher à une ceinture (avec une attache), idéal pour stocker des récompenses, avec l'aide d'une corde peut être ouvert et fermé, en matière robuste et lavable | para colgar del cinturón (con un clip), ideal para almacenar recompensas, con la ayuda de una cuerda puede ser abierto y ser cerrado, fabricado con material resistente, lavable | da fissare alla cintura (con una clip), ideale per conservare snack, si può chiudersi con l'aiuto di un cordoncino, materiale robusto, lavabile | fastgørelse i et bælte (med clip), velegnet til opbevaring af snacks, lukkes med lille snor, robust materiale, kan vaskes indvendigt

schwarz/beige | black/tan | noir/beige | negro/beige | nero/beige | sort/beige

46578 



↕ ■ 10 x 10 x 10 cm 3 Stck. | pcs.
L 14 x 14 x 14 cm 3 Stck. | pcs.

Gürteltasche BUGRINO STANDARD

Belt bag | Sac de ceinture | Bolso para colgar del cinturón | Borsa da cintura | Bæltetaske

zum Befestigen an einem Gürtel (mit Clip), ideal zur Aufbewahrung von Snacks, mit Hilfe einer Kordel verschließbar, robustes Material, auswaschbar, mit Clickertasche | to attach to a belt (with clip), can be opened and closed with the help of a cord, tough material, washable, with clicker bag | à attacher à une ceinture (avec une attache), avec l'aide d'une corde peut être ouvert et fermé, en matière robuste et lavable, avec sac pour clicker | para colgar del cinturón (con un clip), ideal para almacenar recompensas, con la ayuda de una cuerda puede ser abierto y ser cerrado, fabricado con material resistente, lavable, con bolso para clicker | da fissare alla cintura (con una clip), ideale per conservare snack, si può chiudersi con l'aiuto di un cordoncino, materiale robusto, lavabile, con borsa porta clicker | fastgørelse i et bælte (med clip), velegnet til opbevaring af snacks, lukkes med lille snor, robust materiale, kan vaskes indvendigt, med klikkertaske

schwarz/beige | black/tan | noir/beige | negro/beige | nero/beige | sort/beige

M 42369  L 41890 



22 x 18,5 cm 3 Stck. | pcs.

Gürteltasche BUGRINO PROFI

Belt bag | Sac de ceinture | Bolso para colgar del cinturón | Borsa da cintura | Beltetaske

zum Befestigen an einem Gürtel (mit Clip oder Gurt), ideal zur Aufbewahrung von Snacks, mit Hilfe eines Rahmenverschlusses (Metall) leicht verschließbar, mit vielen kleinen Taschen für Clicker oder Handy, robustes Material, auswaschbar, mit Kotbeutelspender, mit Karabiner | to attach to a belt (with clip and strap), ideal for storing rewards, can be opened and closed easily with the help of a frame lock (metal), with lots of small pockets for your clicker or your mobile phone, tough material, washable, with waste bag dispenser, with snap hook | à attacher à une ceinture (avec une attache et une dragonne), idéal pour stocker des récompenses, avec l'aide d'une corde (métal) peut être ouvert et fermé, avec de nombreuses petites poches pour clicker ou téléphone portable, en matière robuste et lavable, avec distributeur de sac sanitaire, avec Mousqueton | para colgar del cinturón (con un clip y una trabilla), ideal para almacenar recompensas, con la ayuda de una cuerda (metal) puede ser abierto y ser cerrado, con numerosos bolsillos para móvil o clicker, fabricado con material resistente, lavable, con dispensador de bolsas para excrementos, con Mosquetón | da fissare alla cintura (con una clip et un laccetto), ideale per conservare snack, si può chiudere con l'aiuto di un cordoncino (metallo), con tante piccole tasche per il clicker o il cellulare, materiale robusto, lavabile, con distributore di sacchetti per escrementi, con Moschettone | til fastgørelse i et bælte (med clip og strop), velegnet til opbevaring af snacks, lukkes med lille snor (metal), robust materiale, kan vaskes indvendigt, med lorteposeautomat, med karabinerhage schwarz/beige | black/tan | noir/beige | negro/beige | nero/beige | sort/beige

46579 





18 x 20 cm 3 Stck. | pcs.

Recycling Umhänge-Snackbeutel ALVA

Snackbag with shoulder strap | Sac à collations à porter autour du cou | Bolsa de merienda al hombro | Borsa snack a tracolla | Skulder snack taske

Recyceltes Polyester (Außen: 600D, Innen: 210D) zum Umhängen (Baumwollgurt) oder Befestigen an einem Gürtel (Schlaufen), ideal zur Aufbewahrung von Snacks, mit Hilfe eines Magnetverschlusses leicht zu öffnen, 3 Fächer im Inneren für Schlüssel, Handy und Co., auswaschbar, wasserdicht, reflektierende Paspel | *Recycled polyester (outside: 600D, inside: 210D) for hanging around (cotton strap) or attaching to a belt (loops), ideal for storing snacks, easy to open with the help of a magnetic closure, 3 compartments inside for keys, mobile phone and co., washable, waterproof, reflective piping* | Polyester recyclé (extérieur : 600D, intérieur : 210D) à porter en bandoulière (sangle en coton) ou à fixer à une ceinture (passants), idéal pour ranger des snacks, s'ouvre facilement à l'aide d'une fermeture magnétique, 3 compartiments à l'intérieur pour les clés, le téléphone portable et autres, lavable, étanche, passepoil réfléchissant | *Poliéster reciclado (exterior: 600D, interior: 210D) para colgarlo (correa de algodón) o sujetarlo al cinturón (trabillas), ideal para guardar los bocadillos, fácil de abrir con la ayuda de un cierre magnético, 3 compartimentos en el interior para las llaves, el teléfono móvil y demás, lavable, impermeable, ribetes reflectantes* | Poliestere riciclato (esterno: 600D, interno: 210D) da appendere (cinturino in cotone) o da agganciare alla cintura (passanti), ideale per riporre gli snack, facile da aprire con l'aiuto di una chiusura magnetica, 3 scomparti all'interno per chiavi, cellulare e altro, lavabile, impermeabile, piping riflettente | *Genbrugspolyester (ydre: 600D, indre: 210D) til at hænge rundt (bomuldsrem) eller fastgøre til et bælte (løkker), ideel til opbevaring af snacks, let at åbne ved hjælp af en magnetisk lukning, 3 rum indeni til nøgler, mobiltelefon og co., vaskbar, vandtæt, reflekterende piping*

69846

gelb | yellow | jaune | amarillo | giallo | gul

204056

marine | navy | marine | marina | blu marino | marineblå

204065

oliv | olive | olive | oliva | oliva | olivenfarvet

204062

grau | grey | gris | gris | grigio | grå

204059

anthrazit | anthracite | anthracite | anthracita | anthracite | antracit

69847



Das großzügige Platzangebot im Inneren sorgt für Ordnung: Handy, Schlüssel und Co. finden neben der Portion Snacks für den besten Freund Platz. Dank praktischem Magnet schließt sich die Tasche von allein, sodass dem Vierbeiner die volle Aufmerksamkeit zuteil wird.

The generous amount of space inside keeps things tidy: mobile phone, keys and co. find space next to the portion of snacks for the best friend. Thanks to the practical magnet, the bag closes by itself, so that the four-legged friend gets all the attention he needs.



Das wasserdichte, griffige Material erfüllt höchste Ansprüche und wird umwelt- und ressourcenschonend hergestellt. 100% recyceltes Polyester, das kann sich sehen lassen! Die reflektierende Paspel unterstützt die optimale Sichtbarkeit des Mensch-Hund-Teams im Straßenverkehr.

The waterproof, non-slip material meets the highest standards and is manufactured in an environmentally friendly and resource-saving way. 100% recycled polyester, that's something to be seen! The reflective piping supports the optimal visibility of the human-dog team in the traffic.

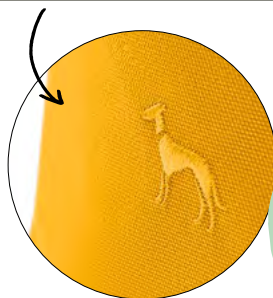

Ob lässig über eine Schulter geschwungen oder diagonal über den Oberkörper – der Snackbeutel passt sich den individuellen Vorlieben perfekt an und ist vor allem eines: immer dabei! Der breite Gurt ist stufenlos längenverstellbar und kann bei Bedarf abgenommen werden.

Whether casually swung over one shoulder or diagonally across the torso - the snack bag adapts perfectly to individual preferences and is above all one thing: always with you! The wide strap is continuously adjustable in length and can be removed if necessary.



Manchmal ist es praktischer, den Snackbeutel auf »Greifhöhe« statt über der Schulter zu tragen. So kann der Vierbeiner schnell belohnt oder das Smartphone für einen tierischen Schnappschuss gezückt werden. Zwei akkurat vernähte Schlaufen garantieren auf den Gürtel gezogen einen stabilen Sitz.

Sometimes it is more practical to carry the snack bag at »grab height« instead of over the shoulder. This way, the four-legged friend can be rewarded quickly or the smartphone can be pulled out for an animal snapshot. Two accurately sewn loops guarantee a stable fit when pulled onto the belt.



■ i IIII
17 x 14 cm 3 Stck. | pcs.

Aus robustem, wasserdichtem Außenmaterial und abwaschbarem Innenmaterial. Innen- und Außenmaterial besteht aus 100% recyceltem Polyester.
Made of robust, waterproof outer material and washable inner material. Inner and outer material is made of 100% recycled polyester.

Recycling-Gürteltasche TYRA

Belt bag | Sac de ceinture | Bolso para colgar del cinturón | Borsa da cintura | Bältetaske

Recyceltes Polyester (Außen: 600D, Innen: 210D), zum Befestigen an einem Gürtel (mit Clip), ideal zur Aufbewahrung von Snacks, mit Hilfe einer Kordel verschließbar, mit integriertem Kotbeutelspender, mit kleiner Tasche für Clicker und Co., auswaschbar | *Recycled polyester (outside: 600D, inside: 210D), to attach to a belt (with clip), ideal for storing snacks, closes with the help of a cord, with integrated poop bag dispenser, with small pocket for clicker and co., washable* | Polyester recyclé (extérieur : 600D, intérieur : 210D), à fixer à une ceinture (avec clip), idéal pour ranger les snacks, se ferme à l'aide d'une cordelette, avec distributeur de sacs à crottes intégré, avec petite poche pour clicker et autres, lavable | *Poliéster reciclado (exterior: 600D, interior: 210D), para sujetar al cinturón (con clip), ideal para guardar los bocadillos, se cierra con la ayuda de un cordón, con dispensador de bolsas de caca integrado, con pequeño bolsillo para el clicker y demás, lavable* | Poliestere riciclato (esterno: 600D, interno: 210D), da attaccare alla cintura (con clip), ideale per riporre gli snack, si chiude con l'aiuto di un cordino, con distributore di sacchetti per la cacca integrato, con piccola tasca per clicker e simili, lavabile | *Genbrugspolyester (udvendigt: 600D, indvendigt: 210D), til at fastgøre til et bælte (med klip), ideel til opbevaring af snacks, lukkes ved hjælp af en snor, med integreret bajspose dispenser, med lille lomme til klikker og co., vaskbar*

beige | tan | beige | beige | beige | beige

69475

khaki | kaki | kaki | caqui | cachi | kaki

69477

braun | brown | marron | marrón | marrone | brun

69476

grau | grey | gris | gris | grigio | grå

69474





16 x 13 cm

Snackbeutel SOFIA

Snack bag | Sac de récompense | Bolsa de recompensa | Borse per spuntini | Snack taske

Kunstleder, vegan, Rindnappa-Optik, mit Karabiner zum Einhängen an Gürtelschlaufe oder Tasche, ideal zur Aufbewahrung von Snacks, mit Hilfe eines Magnetverschlusses leicht zu öffnen | faux leather, vegan, cowhide nappa look, with carabiner for hooking onto a belt loop or bag, ideal for storing snacks, easy to open with the help of a magnetic fastener | Similicuir, végétalien, aspect nappa de bœuf, avec mousqueton pour accrocher à un passant de ceinture ou à un sac, idéal pour ranger des snacks, s'ouvre facilement à l'aide d'une fermeture magnétique | Imitación de cuero, vegano, con aspecto de napa de vaca, con mosquetón para engancharlo a la trabilla del cinturón o al bolso, ideal para guardar aperitivos, fácil de abrir con ayuda de un cierre magnético | Finta pelle, vegana, aspetto nappa di vacchetta, con moschettone per agganciarlo al passante della cintura o alla borsa, ideale per conservare gli snack, facile da aprire con l'aiuto di una chiusura magnetica | Kunstleder, vegansk, koskind med nappa-look, med karabinhage til at hægte på en bæltestropp eller taske, ideel til opbevaring af snacks, nem at åbne ved hjælp af en magnetlukning

rot | red | rouge | rojo | rosso | rød

205203 

himbeer | raspberry | framboise | frambuesa | lamponne | hindbær

205191 

braun | brown | marron | marrón | marrone | brun

205215 

schwarz | black | noir | negro | nero | sort

205227 





besonders
ROBUST
particularly durable



III
3 Stck. | pcs.

Trainer Snack Dummy TOUGH POMBAS

PVC/Polyester, mit Reißverschluss, befüllbar mit Snacks, bei 30°C waschbar | PVC/Polyester, with zipper, can be filled with snacks, washable at 30°C | PVC/Polyester, avec une fermeture à glissière, à remplir de friandises, lavable à 30°C | PVC/Poliéster, con cremallera, se puede rellenar con comida, lavable a 30°C | PVC/Polyester, con chiusura lampo, si può riempire con snack, lavabile a 30°C | PVC/Polyester, med lymås, kan fylles med godbidder, vaskbar ved 30°C

orange/beige | orange/tan | orange/beige | naranja/beige | arancione/beige | orange/beige

20 cm 67866



34 cm
Gesamtlänge
total length



III
3 Stck. | pcs.

Trainer Snack Dummy mit Seil

Trainer Snack Dummy with rope | Trainer Snack Dummy avec corde | Trainer Snack Dummy con cuerda | Trainer Snack Dummy con corda | Trainer Snack Dummy med reb

Polyester/Nylon, mit Reißverschluss, befüllbar mit Snacks, mit Tau | Polyester/Nylon, with zipper, can be filled with snacks, with rope | Polyester/Nylon, avec une fermeture à glissière, à remplir de friandises, avec corde | Poliéster/Nylon, con cremallera, se puede rellenar con comida, con cuerda | Polyester/Nylon, con chiusura lampo, si può riempire con snack, con corda | Polyester/Nylon, med lymås, kan fylles med godbidder, med tov

orange/schwarz | orange/black | orange/noir | naranja/negro | arancione/nero | orange/sort

20 cm 67865



III
3 Stck. | pcs.

Trainer Snack Dummy

Polyester, mit Reißverschluss, befüllbar mit Snacks, bei 30°C waschbar | Polyester, with zipper, can be filled with snacks, washable at 30°C | Polyester, avec une fermeture à glissière, à remplir de friandises, lavable à 30°C | Poliéster, con cremallera, se puede rellenar con comida, lavable a 30°C | Polyester, con chiusura lampo, si può riempire con snack, lavabile a 30°C | Polyester, med lymås, kan fylles med godbidder, vaskbar ved 30°C

1: orange | orange | orange | naranja | arancione | orange

15 cm 42579

2: beige | tan | beige | beige | beige | beige

20 cm 42098

3: grau | grey | gris | gris | grigio | grå

25 cm 42580

4: dunkelgrau | dark grey | gris foncé | gris oscuro | grigio scuro | mørkegrå

30 cm 42581



49 cm
Gesamtlänge
total length

besonders
ROBUST
particularly durable

III
3 Stck. | pcs.

Dummy TRIENT

Trainingsdummy aus extrem strapazierfähigem, widerstandsfähigem Nylon, ideal für Training und Spiel, mit Handschlaufe | *Training dummy made from extremely hard-wearing, robust nylon, ideal for training and games, with wrist strap* | Dummy d'entraînement en nylon extrêmement solide et résistant, idéal pour les séances d'entraînement et de jeu, avec dragonne | *Dummy de entrenamiento hecho de nylon robusto y resistente, ideal para entrenamientos y juegos, con correa de mano* | Dummy da addestramento in nylon estremamente robusto e resistente, ideale per l'addestramento e il gioco, con cinturino da polso | *Trænings-dummy i ekstra slidstærkt, modstandsdygtigt nylon, perfekt til træning og leg, med håndrem*

rot | red | rouge | rojo | rosso | rød

30 cm 65896 



III
6 Stck. | pcs.

Erziehungshilfe TRAINER DISC

Education assistance | *Pour éducation* | *Para entrenamiento* | *Strumento di addestramento* | *Dressurhjælp*

Würfchellen aus Metall, ideal zur Verhinderung unerwünschter Verhaltensweisen (z.B. Bellen, Anspringen von Personen) | *Metal throwing bells, ideal for preventing unwanted behaviours (e.g. barking, jumping at people)* | Disques d'entraînement en métal, idéaux pour parer à des comportements indésirables (par ex. aboiements, sauts sur des personnes) | *Discos de entrenamiento de metal, perfectos para evitar comportamientos no deseados (por ej. ladridos o saltos hacia personas)* | Dischi di Fischer in metallo, ideali per evitare tipi di comportamento indesiderati (ad esempio l'abbaiare prolungato, saltare addosso alla gente) | *Kastebøjler af metal, ideel til forhindring af uønsket adfærd (f.eks. gøning, springning op på personer)*

41936 







Trainer Snack Dummy mit Seil

Trainer Snack Dummy with rope | Trainer Snack Dummy avec corde | Trainer Snack Dummy con cuerda | Trainer Snack Dummy con corda | Trainer Snack Dummy med reb

Polyester, mit Reißverschluss, befüllbar mit Snacks, mit Tau | Polyester, with zipper, can be filled with snacks, with rope | Polyester, avec une fermeture à glissière, à remplir de friandises, avec corde | Poliéster, con cremallera, se puede rellenar con comida, con cuerda | Polyester, con chiusura lampo, si può riempire con snack, con corda | Polyester, med lynlås, kan fylles med godbidder, med tov

altrosa | old pink | vieux rose | rosa viejo | rosa antico | gammel pink

20 cm 201779 

taupe

20 cm 201770 

schwarz | black | noir | negro | nero | sort

20 cm 201761 



3 Stck. | pcs.



34 cm
Gesamtlänge
total length





■ 6,3 x 3,1 x 1,8 cm ■■■ 6 Stck. | pcs.

Clicker mit Universalarmband

Clicker universal wristband | Bracelet pour clicker taille unique | Pulsera clicker universal | Cinghia da polso universale con clicker | Clicker universalarmband

Kunststoff/Metall, mit elastischem Universalarmband, farblich sortiert | *Plastic/Metal, with elastic universal armband, assorted colours* | *Plastique/Métal, avec bracelet élastique universel, couleurs assorties* | *Plástico/Metal, con banda elástica universal, disponible en distintos colores* | *Plastica/Metallo, con bracciale elastico universale, colori assortiti* | *Kunststoff/Metal, med universalarmband, farvemæssigt sorteret*

92329 



■ 7 x 4 cm ■■■ 6 Stck. | pcs.

Clicker mit Umhängeband und Fingerschleufe

Clicker with lanyard and finger loop | Clicker avec cordon et boucle pour le pouce | Clicker con cinta para colgar y trabilla para dedo | Clicker con cordino e passante | Clicker med bånd og fingersløjfe

Kunststoff, einfache Handhabung, mit elastischer Fingerschleufe und Umhängeband, gut hörbarer Click-Sound, ideal für Training & Ausbildung | *Plastic, easy to handle, with elasticated finger strap and lanyard, easily audible click sound, ideal for training* | *Plastique, manipulation facile, avec boucle pour le doigt élastique et dragonne, son « clic » bien distinct, idéal pour l'entraînement et le dressage à base de protéines animales* | *Plástico, manejo sencillo, con correa elástica para dedo y correa para colgar, sonido de clic bien audible, ideal para entrenamientos y formación* | *Materiale sintetico, semplice manovrabilità, con passante elastico per dito e nastro da collo, click-sound ben udibile, ideali per l'addestramento e formazione* | *Kunststof, nem håndtering, med elastisk fingerstrop og strop til at tage rundt om, hørbar click-lyd, ideelt til træning & uddannelse*

66203 

Clicker+ Pfeife

Clicker & whistle



■ 8 x 4 cm ■■■ 6 Stck. | pcs.

2in1 Clicker mit Umhängeband

2in1 clicker with lanyard | Clicker 2en1 avec cordelette | Clicker 2en1 con cinta para el cuello | Clicker 2in1 con cordoncino | 2in1 klik med nakkestrop

Kunststoff, 2-in-1: Clicker und Pfeife (5000 Hz), mit Umhängeband oder Clip variabel an der Kleidung zu befestigen | *Plastic, 2-in-1: clicker and whistle (5,000 Hz) can be adjustably attached to clothing with a lanyard or clip* | *Plastique, 2 en 1 : clicker et sifflet (5000 Hz), avec lanière ou clip à attacher en toute flexibilité sur les vêtements* | *Plástico, diseño 2 en 1: clicker y silbato (5000 Hz), con cinta para colgar o clip para fijar de forma flexible a la ropa* | *Plastica, 2 in 1: clicker e fischiello (5000 Hz) attaccabili agli indumenti a piacere con laccio o clip* | *Plastik, 2-i-1: klikker og fløjte (5000 Hz), med lanyard eller klip, der variabel kan fastgøres på tøjet*

67789 



7 x 2 cm 6 Stck. | pcs.

Doppeltonpfeife JULA

Two-tone whistle | Sifflet deux tons | Silbato de doble tono | Fischietto a doppio tono | Dobbelt-tone-pifte

Kunststoff, Erzeugung zweier unterschiedlicher Pfeiföne (4700 Hz, 3100 Hz) möglich, mit Umhängeband oder Clip variabel an der Kleidung zu befestigen | Plastic, capable of generating two different whistle frequencies (4,700 Hz or 3,100 Hz); can be adjustably attached to clothing with a lanyard or clip | Plastique, émission de deux tonalités de sifflement différentes (4700 Hz, 3100 Hz), avec lanière ou clip à attacher en toute flexibilité sur les vêtements | Plástico, emite dos tonos de distinta intensidad (4700 Hz, 3100 Hz), con cinta para colgar o clip para fijar de forma flexible a la ropa | Plastica, possibile la produzione di due diverse tonalità di fischio (4700 Hz, 3100 Hz) attaccabile agli indumenti a piacere con laccio o clip | Plastik, generation af to forskellige fløjtoner (4700 Hz, 3100 Hz) mulig med en lanyard eller klip variabelt fastgjort til tøjet

67790 





↗	↔	↔
S	max. 30 cm	3,5 cm
M	max. 40 cm	3,5 cm
L	max. 50 cm	3,5 cm
XL	max. 60 cm	3,5 cm

Warnband mit Klettverschluss

Warning reflecting strap with velcro fastener | Limite de signalisation avec fermeture velcro | Limite reflectante con cierre de velcro | Collare riflettente con chiusura a velcro | Sikkerhedsbånd med velcrolukning

Nylon, elastisch, reflektierend, mit Klettverschluss | Nylon, elastic, reflective, with velcro fastening | Nylon, élastique, réfléchissant, avec fermeture velcro | Nylon, elástico, reflectante, con cierre de velcro | Nylon, elastico, riflettente, con chiusura a velcro | Nylon, elastisk, refleks, med velcrolukning

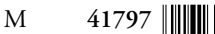
orange | orange | orange | naranja | arancione | orange

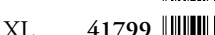
S 41796  M 41797 
L 41798  XL 41799 

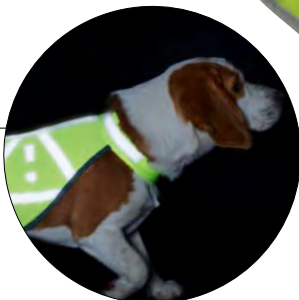

↗	↔	↔
S	28 – 42 cm	39 – 50 cm
M	42 – 50 cm	50 – 68 cm
L	48 – 62 cm	64 – 81 cm

Warnweste für Hunde

Safety waistcoat for dogs | Gilet de haute visibilité pour chiens | Chaleco de alta visibilidad para perros | Gilet ad alta visibilità per cani | Synlighedsvest til hunde

Polyester, reflektierend, mit Klettverschluss, waschbar bei 30 °C | Polyester, reflective, with velcro fastener, washable at 30 °C | Polyester, réfléchissant, avec fermeture velcro, lavable à 30 °C | Poliéster, reflectante, con cierre de velcro, lavable à 30 °C | Poliester, riflettente, con chiusura a velcro, lavabile a 30 °C | Polyester, reflekterende, med velcrolukning, vaskbar ved 30 °C

S 42229  M 42230 
L 42231 

Kopfgeschirr
Head harness



Ausbildungsgeschirr FOLLOW ME

Education harness | Harnais d'éducation | Arnés de adiestramiento | Pettorina da addestramento | Grime

einfache Handhabung, selbst stark ziehende oder aggressive Hunde lassen sich mit diesem Hundegeschirr mit geringstem Kraftaufwand gut kontrollieren, kann auch als Halsung verwendet werden | *simple handling, even energetic or aggressive dogs can be controlled with minimal effort using this dog harness* | manient simple, même les chiens tirant fortement sur leur laisse ou les chiens agressifs se laissent facilement dominer avec peu d'efforts | *fácil aplicación, incluso los perros con mucha fuerza o agresivos pueden controlarse sin gran esfuerzo con estos arneses* | facile da maneggiare, mediante questa pettorina è possibile controllare con il minimo sforzo anche i cani più aggressivi e forti | *enkel håndtering, selv stærkt trækkende eller aggressive hunde er lette at kontrollere med dette seletoj uden at der skal bruges de helt store kræfter*

schwarz | black | noir | negro | nero | sort

M 35922  L 35923 

XL 35924 

*Die Passform ist abhängig von den Proportionen (Hals zu Schnauze) des Hundes, daher können die o.g. Maße nur zur groben Orientierung verwendet werden. *The fit depends on the proportions (neck to muzzle) of the dog, therefore the above measurements can only be used as a rough guide.*

⇒	↔*	↔
M	max. 40 cm*	1,5 cm
L	max. 50 cm*	2,0 cm
XL	max. 60 cm*	2,0 cm





Kunststoff Maulkorb

Plastic muzzle | Plastique muselière | Plástico bozal | Plastica museruola | Kunststof mndkurb

Kunststoff / Nylon | Plastic / Nylon | Plastique / Nylon | Plástico / Nylon
| Plastica / Nylon | Kunststof / Nylon

1	92493		2	92494	
3	92495		4	92496	
5	92497		6	92498	
7	92499		8	92500	
9	92501				

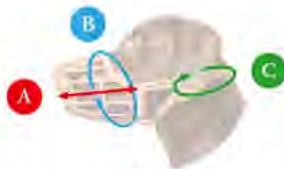

Größe Size	A Schnauzenlänge cm/ Snout length (cm)	B Schnauzenumfang cm/ Muzzle circumference	C Bandlänge cm / Strap length (cm)
1	max. 4 – 6	max. 16	max. 40
2	max. 5 – 6	max. 19	max. 42
3	max. 5 – 7	max. 21	max. 44
4	max. 5 – 7	max. 23	max. 46
5	max. 6 – 8	max. 25	max. 50
6	max. 6 – 10	max. 28	max. 54
7	max. 7 – 10	max. 32	max. 62
8	max. 8 – 11	max. 35	max. 67
9	max. 8 – 12	max. 37	max. 72

PerfectFIT

ÄUSSERST KOMFORTABEL
extremely comfortable



Herausnehmbarer Giftköderschutz
Removable poison bait protection



Maulkorb ALBURY

Muzzle | Muselière | Bozal | Museruola | Mundkurv

Maulkorb aus einem Stück robusten und flexiblen Kunststoff, Polsterung im Stirn- und Nasenbereich für einen optimalen und angenehmen Sitz, stufenlos verstellbare Nylonriemen, leicht zu reinigen, es bleibt dem Hund möglich zu trinken, zu hecheln und ggf. auch zu erbrechen, lässt sich nicht vom Hund abstreifen, mit Giftköderschutz | *Muzzle made from one piece of robust, flexible plastic, padding around the nose and forehead for a snug and comfortable fit, infinitely adjustable nylon straps, easy to clean, the dog is still able to drink, pant and regurgitate if necessary, the dog is not able to take the device off, delivered with a protective muzzle* | Muselière fabriquée en une seule pièce de plastique solide et flexible, rembourrage dans la zone du front et de la truffe, pour un maintien optimal et agréable, sangles en nylon ajustables en continu, simple à nettoyer, le chien peut toujours boire, haleter et éventuellement vomir, livré avec une protection contre les appâts empoisonnés, le chien ne peut pas l'enlever | *Bozal de una pieza de plástico resistente y flexible, acolchado en la zona de la frente y el hocico para un ajuste perfecto y cómodo, correa de nailon de ajuste continuo, fácil de limpiar, permite al perro beber, jadear y en caso necesario, incluso vomitar, el perro no puede quitárselo por sí solo, se envía con protección frente a venenos* | Museruola in materiale sintetico robusto e flessibile formata da un unico pezzo, imbottitura nell'area frontale e nasale per essere perfetta e comoda quando indossata, cinghie in nylon regolabili gradualmente, facile da pulire, il cane continua a poter bere, ansimare ed eventualmente anche rimettere, non può essere strappata dal cane, consegnato con una museruola con retina | *Mundkurv i et stykke robust og fleksibelt kunststof, polstring i pande- og naseområde sørger for en optimal bærekraft, trinløs justerbar nylonrem, nemt at rengøre, hunden kan stadig drikke, gispe og i givet fald kaste op, kan ikke fjernes af hunden, bliver leveret med beskyttelse mod forgiftet lokkemad*

- | | | | | | |
|---|-------|--|---|-------|--|
| 1 | 65545 | | 2 | 65546 | |
| 3 | 65547 | | 4 | 65548 | |
| 5 | 65549 | | 6 | 65550 | |

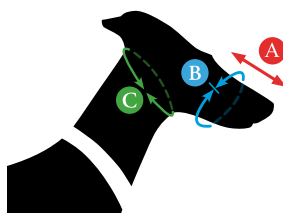

Maulkorbgröße Muzzle size*	1	2	3	4	5	6
A	4 cm	5,5 cm	6,3 cm	7 cm	8,5 cm	9,5 cm
B	14 cm	19 cm	21,5 cm	25 cm	30 cm	33 cm
C	45 cm	54 cm	62 cm	69 cm	78 cm	85 cm

Verwendung von TPE ermöglicht durch Erwärmen in heißem Wasser (ca. 10 Minuten, >70 °C) eine leichte Verformung und somit Anpassung an die Hundeschnauze

Use of TPE enables slight deformation and thus adaptation to the dog's snout by heating in hot water (approx. 10 minutes, >70 °C)



Vielfältige Anwendungsmöglichkeiten (Reisen, Angst und Aggression, nach Operationen etc.)
Wide range of applications (travel, fear and aggression, after surgery, etc.)



Stufenlos verstellbare Nylon-Riemen für einen sicheren Sitz
Infinitely adjustable nylon straps for a secure fit

AUCH IN KLEINEN GRÖSSEN

Also in small sizes



Vorbeugend gegen Giftköder
Preventive against poisoned bait



Großzügiges Gitter ermöglicht Hecheln, Wasseraufnahme und Erbrechen
Generous grille allows panting, water intake and vomiting

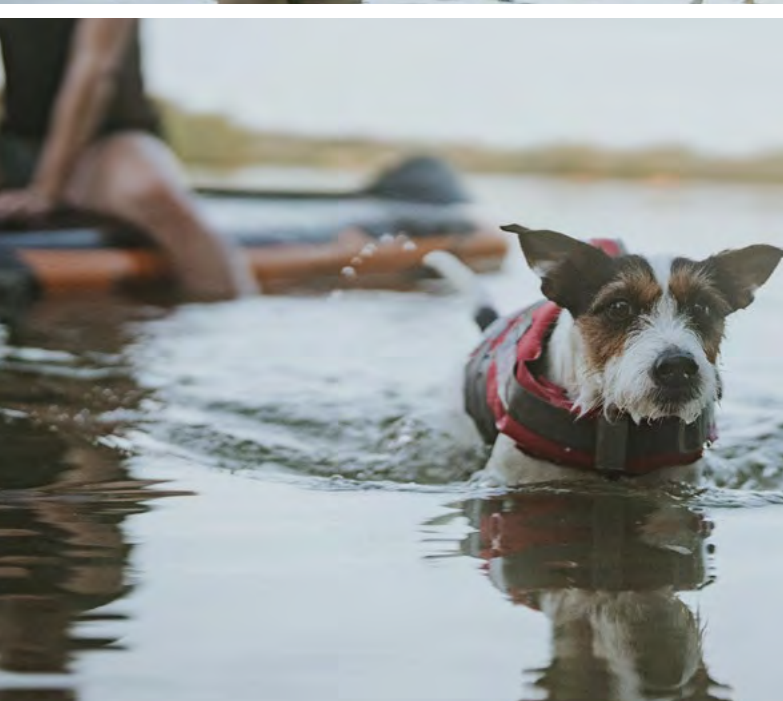



⇒	■i	↔*	↔.	↵
S	22,5 cm	28 – 37 cm	44 – 55 cm	max. 15 kg
M	26,0 cm	34 – 40 cm	51 – 65 cm	max. 20 kg
L	31,5 cm	40 – 50 cm	58 – 70 cm	max. 30 kg
XL	36,0 cm	50 – 56 cm	70 – 90 cm	max. 35 kg
XXL	43,0 cm	56 – 62 cm	88 – 119 cm	max. 45 kg

↖ **Rückenlänge**
Back length

↗ **Empfohlenes Gewicht des Hundes**
Recommended dog weight

Schwimmweste Moss

Life jacket | Gilet de sauvetage | Chaleco salvavidas | Giubbotto di salvataggio | Redningsvest

Polyester, reflektierend, zwei Sicherheitsklickverschlüsse am Bauchriemen, Bauch- und Brustriemen stufenlos verstellbar | *Polyester, reflective, two safety snap fasteners at the stomach strap, continuously adjustable stomach strap and chest belt* | Polyester, réfléchissant, deux fermetures de sécurité à clips abdominales et thoraciques réglables en continu | *Poliéster, reflectante, dos correas con cierre de seguridad en abdomen, correas de ajuste continuo en abdomen y pecho* | Poliestere, riflettente, due chiusure a scatto nella cinghia per l'addome, cinghie per petto e addome regolabili | *Polyester, reflektierende, to sikkerbedskliklåse på maveremmen, trinløs indstilling af bryst- og maverem*

rot | red | rouge | rojo | rosso | rød

S	62444		M	62445	
L	62446		XL	62447	
XXL	62448				



- Schwimmweste mit Handschleufe für Hunde**
Swim vest with hand strap for dogs
- Ideal für Boots- und Kanutouren sowie Stand-up-Paddling**
Ideal for boat and canoe trips as well as stand-up paddling
- Mit Klett- und Klickverschlüssen am Bauch**
With Velcro and click fasteners on the belly
- Optimale Sicherheit durch gute Sichtbarkeit**
Optimal safety due to good visibility
- Pflegeleicht und abwaschbar**
Easy to clean and washable



Zubehör

— *Accessories* —

Das große Angebot an Zubehörartikeln auf dem Markt stellt viele vor die Qual der Wahl. Um Ihnen die Auswahl ein wenig zu erleichtern, beschränkt sich das Sortiment von HUNTER ausschließlich auf die sinnvollen, praktischen und hochwertigen Produkte.

The wide selection of accessories and toiletries on the market presents problems for many people: which products shall I choose? In order to make your choice a little bit easier, the HUNTER assortment is limited to useful, practical and the most important products of the highest quality.



Adresshülse

Identification tube | Tube porte adresse | Estuche metálico para la dirección | Pendente porta indirizzo | Adresseshylster

Aluminium, mit Adresskärtchen | Aluminum, with address card | Aluminium, avec plaquette d'identification | Aluminio, con placa para la dirección | Aluminio, con bigliettino d'indirizzo | Aluminium, med adresseskilt

orange | orange | orange | naranja | arancione | orange

S 91371  M 91372 

⇒	Ø	■i	
S	1,0 cm	3,5 cm	12 Stck. pcs.
M	1,5 cm	4,0 cm	12 Stck. pcs.



3,5 x 2,5 cm

Designkarabiner EASY CHANGE

Design snap hook | Mousqueton design | Mosquetón de diseño | Moschettone design | Designkarabinerhage

Edelstahl, zum schnellen Auswechseln und Befestigen von Anhängern und Hundemarken, einfache Handhabung | Stainless steel, for quick exchange and attachment of pendants and dog tags, easy to handle | Inox, pour l'échange et la fixation rapides des remorques et des plaques d'identification des chiens, manipulation facile | Acero, para un rápido intercambio y fijación de remolques y placas de identificación, manejo sencillo | Acciaio inossidabile, per lo scambio e il fissaggio rapido di rimorchi e targhette per cani, emplice manovrabilità | Rustfrit stål, til hurtigt at ændre og vedhæfte tags og hundemærker, nem håndtering

5 Stck. | pcs. 61725 



||||
5 Stck. | pcs.



3 Rollen, je 10 Beutel
3 rolls, 10 bags each



BIOLOGISCH ABBAUBAR
Biodegradable • Biodegradable

III
12 x 3 Stck. | pcs.

Hundekotbeutel kompostierbar

Dog waste bag compostable | Sachet pour déjections canines compostable | Porta bolsas para excrementos biodegradable | Buste per la raccolta di escrementi canini biodegradabile | Hundelortpose komposterbart

Polyester, kompostierbar, 10 Kottüten pro Rolle, 3 Rollen pro Verpackung | Polyester, compostable, 10 waste bags per roll, 3 rolls per pack | Polyester, compostable, 10 sachets excréments par rouleau, 3 rouleaux par paquet | Poliéster, biodegradable, 10 bolsitas higiénicas por rollo, 3 rollos por paquete | Poliestere, biodegradabile, 10 bustine per escrementi per rotolo, 3 rotoli per confezione | Polyester, komposterbart, 10 lorteposer per rulle, 3 ruller pr. pakke

92425



3DSoft Comfort Material

II
9,5 x 5,0 cm
III
6 Stck. | pcs.

Kotbeutelspender HILO

Waste bag dispenser | Distributeur de sac sanitaire | Dispensador de bolsas para excrementos | Distributore di sacchetti per escrementi | Lorteposeautomat

Polyester/3D-Mesh-Material, mit praktischem Karabiner zur variablen Befestigung, befüllbar mit handelsüblichen Kotbeutel-Rollen (nicht im Lieferumfang enthalten) | Polyester/3D mesh material, with practical carabiner for versatile fastening, able to be filled with normal-sized rolls of waste bags (not included) | Polyester / Matériau mesh 3D, avec mousqueton pratique pour fixation variable, remplissage possible avec des rouleaux de sacs à excréments standard (non inclus) | Poliéster/Material mesh 3D, con práctico mosquetón para fijar a medida, se rellena con rollos de bolsas para excrementos (no incluidos) | Poliestere/Material de malla 3D, con pratico moschettone per il fissaggio variabile, può essere riempito con rotoli standard di sacchetti per escrementi (non inclusi) | Polyester/3D-mesh-materiale, med praktisk karabiner til variabel fastgørelse, kan fyldes med standard hundepose-ruller (ikke inkluderet)

orange | orange | orange | naranja | arancione | orange

67473

rot | red | rouge | rojo | rosso | rød

67474

limette | lime | citron vert | limón | limetta | limone

67472

blau | blue | bleu | azul | blu | blå

67476

türkis | turquoise | turquoise | turquesa | turchese | turkis

67475

braun | brown | marron | marrón | marrone | brun

67471

anthrazit | anthracite | anthracite | anthracita | anthracite | antracit

67470



Display: Leder & Farben können variieren
Leather & colours may vary



III
32/Display



III
10 x 5 cm 6 Stck. | pcs.

Display Kotbeutelspender YUNA

Display, waste bag dispenser | Support, distributeur de sac sanitaire | Soporte, dispensador de bolsas para excrementos | Espositore Distributore di sacchetti per escrementi | Display, lorteposeautomat

67202



inkl. Kotbeutelrolle
incl. waste bag roll

Kotbeutelspender YUNA

Waste bag dispenser | Distributeur de sac sanitaire | Dispensador de bolsas para excrementos | Distributore di sacchetti per escrementi | Lorteposeautomat

Leder (diverse), mit praktischem Ringkarabiner zur variablen Befestigung | Cowhide and other leathers, features a practical ring clasp for flexible attachment | Cuir de vachette et autres cuirs, avec mousqueton pratique pour fixation variable | Cuero vacuno y otros tipos de cuero, con práctico mosquetón para fijar a medida | Pelle bovina e altro pellame, con pratico moschettone ad anello per fissaggio regolabile | Kobud og andet leder, med praktisk ringformede karabiner til variabel fastgørelse

rot | red | rouge | rojo | rosso | rød

67208

pink | pink | rose | rosa | rosa carico | pink

67204

limette | lime | citron vert | limón | limetta | limone

67205

cognac | cognac | cognac | coñac | cognac | cognac

67209

grau | grey | gris | gris | grigio | grå

67206

schwarz | black | noir | negro | nero | sort

67207



13 x 10 x 5 cm 6 Stck. | pcs.

Kotbeutelspender VARDE

Waste bag dispenser | Distributeur de sac sanitaire | Dispensador de bolsas para excrementos | Distributore di sacchetti per escrementi | Lorteposeautomat

Rindsleder, mit praktischem Karabiner zur variablen Befestigung, befüllbar mit handelsüblichen Kotbeutel-Rollen (1 Rolle bereits im Lieferumfang enthalten) | Cowhide, with practical carabiner for variable attachment, can be filled with standard waste bag rolls (1 roll already included) | Cuir de boeuf, avec mousqueton pratique pour une fixation variable, peut être rempli avec des rouleaux de sacs à crottes usuels (1 rouleau déjà inclus dans la livraison) | Piel de vaca, con práctico mosquetón para fijación variable, se puede rellenar con rollos de bolsa de caca estándar (1 rollo ya incluido) | In pelle di mucca, con pratico moschettone per il fissaggio variabile, può essere riempito con rotoli di sacchetti di cacca standard (1 rotolo già incluso) | Koskind, med praktisk karabinhage til variabel fastgørelse, kan fyldes med standardposeruller (1 rulle er allerede inkluderet)

dunkelbraun | dark brown | marron foncé | marrón oscuro | marrone scuro | mørkebrun

69548

schwarz | black | noir | negro | nero | sort

69549



95 x 12 cm 12/Clipstrip
10 x 5 cm 6 Stck. | pcs.

Kotbeutelspender LOVE

Waste bag dispenser | Distributeur de sac sanitaire | Dispensador de bolsas para excrementos | Distributore di sacchetti per escrementi | Lorteposeautomat

Rindsleder, Nappa, mit praktischem Ringkarabiner zur variablen Befestigung, befüllbar mit handelsüblichen Kotbeutel-Rollen (1 Rolle bereits im Lieferumfang enthalten) | Cow leather, Nappa, features a practical ring clasp for flexible attachment, can be filled with standard rolls of dog waste bags (1 roll included in delivery) | Cuir de boeuf, Nappa, avec mousqueton pratique pour fixation variable, peut être rempli avec des rouleaux de sacs à excréments standard (1 rouleau inclus dans la livraison) | Cuero de vacuno, Napa, con práctico mosquetón para fijar a medida, se rellena con rollos de bolsas para excrementos (1 rollo ya incluido en la entrega) | Cuoio di bovina, Nappa, con pratico moschettone ad anello per fissaggio regolabile, può essere riempito con i normali rotoli di sacchetto per gli escrementi (1 rotolo compreso nella fornitura) | Okselæder, Nappa, med praktisk ringformede karabiner til variabel fastgørelse, kan fyldes med standard hundepose-ruller (1 rulle allerede inkluderet)

Clipstrip

69410

rot | red | rouge | rojo | rosso | rød

69409

braun | brown | marron | marrón | marrone | brun

207522



Inklusive individuell einsetzbarem Snackbeutel

Including individually usable snack bag



33 x 9,5 x 17 cm



3 Stck. | pcs.

Crossbody-Tasche CHARLOTTE

Crossbody bag | Sac à bandoulière | Bolso cruzado | Borsa a tracolla | Crossbody-taske

Polyester, abwaschbar, mehrere Staufächer, inklusive individuell einsetzbarem Snackbeutel, stufenlos verstellbarer Schultergurt, integrierter Kotbeutelspender | *Polyester, washable, several storage compartments, including individually usable snack bag, infinitely adjustable shoulder strap, integrated poo bag dispenser* | Polyester, lavable, plusieurs compartiments de rangement, sac à friandises individuel inclus, bandoulière réglable en continu, distributeur de sacs à crottes intégré | *Poliéster, lavable, varios compartimentos de almacenamiento, incluida bolsa de merienda utilizable individualmente, correa para el hombro infinitamente ajustable, dispensador de bolsas de caca integrado* | Poliestere, lavabile, diversi scomparti, tra cui un sacchetto per la merenda utilizzabile singolarmente, tracolla regolabile in continuo, dispenser per sacchetti di cacca integrato | *Polyester, vaskbar, flere opbevaringsrum, inklusive snackpose, der kan tilpasses, trinløs justerbar skulderrem, integreret lorteposedispenser*

1: grün/lila | green/purple | vert/violet | verde/morado | verde/viola | grøn/lilla

207646

2: greige/gelb | greige/yellow | greige/jaune | greige/amarillo | greige/giallo | greige/gul

207643

3: braun/taupe | brown/taupe | marron/taupe | marrón/taupe | marrone/taupe | brun/taupe

207640



Schmutz- und wasserabweisend
Dirt and water repellent



Integrierter Kotbeutelspender
Integrated poo bag dispenser



MADE
IN
GERMANY

III
6 Stck. | pcs.



**KEIN
»KLIMPERN«
MEHR**
No more »jingling«!

MADE
IN
GERMANY

↕	Ø	III
S	4,3 cm	6 Stck. pcs.
M	4,8 cm	6 Stck. pcs.

Schlüsselanhänger LOVE

Keychain | Porte-clés | Llaveró | Portachiavi | Nøglering

Rindsleder, mit Schlüsselring | *Cowhide leather, with key ring* | Cuir de bœuf, avec anneau pour clés | *Piel de vaca, con llaveró* | In pelle di vacchetta, con anello portachiavi | *Okselæder, med nøglering*

rot | red | rouge | rojo | rosso | rød

4,8 cm 69994

Anhänger Hundemarken-Etui LOVE

Dog Tag Case Pendant | Pendentif Étui pour marques de chien | Colgante Estuche Etiqueta de Perro | Ciondolo a forma di medaglietta per cani | Vedhæng til hundetageske

Rindsleder, für Adress- und Steuermarken, schützt die Marke und verhindert Klimpern, mit Schlüsselring | *Cowhide leather, for address and tax tags, protects the stamp and prevents jingling, with key ring* | Cuir de bœuf, pour timbres-adresses et timbres fiscaux, protège le timbre et empêche le tintement, avec anneau pour clés | *Piel de vaca, para sellos de direcciones e impuestos, protege el sello y evita el tintineo, con llaveró* | In pelle di vacchetta, per timbri di indirizzo e fiscali, protegge il timbro e impedisce il tintinnio, con anello portachiavi | *Okselæder, til adresse- og skattefrimærker, beskytter frimærket og forhindrer klirren, med nøglering*

rot | red | rouge | rojo | rosso | rød

S 69992 M 69993

braun | brown | marron | marrón | marrone | brun

S 207518 M 207520





**KEIN
»KLIMPERN«
MEHR**
No more »jingling«!

auch als
Clipstrip
12/Clipstrip

farblich sortiert
assorted colours



↕	∅	
S	4,3 cm	6 Stck. pcs.
M	4,8 cm	6 Stck. pcs.
Clipstrip	95 x 12 cm	12 Stck. pcs.

Anhänger Hundemarken-Etui

AALBORG

*Dog Tag Case Pendant | Pendentif Étui pour marques de chien
| Colgante Estuche Etiqueta de Perro | Ciondolo a forma di
medaglietta per cani | Vedhæng til hundetageske*

Rindsleder, für Adress- und Steuermarken, schützt die Marke und verhindert Klimpern, mit Schlüsselring | *Cowhide leather, for address and tax tags, protects the stamp and prevents jingling, with key ring* | Cuir de bœuf, pour timbres-adresses et timbres fiscaux, protège le timbre et empêche le tintement, avec anneau pour clés | *Piel de vaca, para sellos de direcciones e impuestos, protege el sello y evita el tintineo, con llavero* | In pelle di vacchetta, per timbri di indirizzo e fiscali, protegge il timbro e impedisce il tintinnio, con anello portachiavi | *Okselæder, til adresse- og skattefrimærker, beskytter frimærket og forhindrer klirren, med nøglering*
Clipstrip / Assorted colours

68300

rot | red | rouge | rojo | rosso | rød

S 69995 M 69996

cognac | cognac | cognac | coñac | cognac | cognac

S 68294 M 68295

dunkelbraun | dark brown | marron foncé | marrón oscuro | marrone scuro
| mørkebrun

S 68296 M 68297

schwarz | black | noir | negro | nero | sort

S 68298 M 68299





16 x 2 cm

Leinenhalter BARRIT ALU-STRONG

Leash holder | Support de laisse | Soporte de línea | Porta guinzaglio | Lineholder | Lijnhouder

Rindsleder, Steckverschluss aus Aluminium, Leine schnell und einfach verstauen, unabhängig von der Länge, individuelle Befestigungsmöglichkeiten (Gürtel, Rucksack etc.) | *Cow leather, buckle made of aluminium, Leash can be stowed away quickly and easily, regardless of length, individual fastening options (belt, rucksack, etc.)* | Cuir de boeuf, fermeture à clips pratique d'aluminium, rangement rapide et facile de la laisse, quelle que soit sa longueur, possibilités de fixation individuelles (ceinture, sac à dos, etc.) | *Cuero de vacuno, cierre a presión de aluminio, La correa se puede guardar rápida y fácilmente, independientemente de su longitud, con opciones de sujeción individuales (cinturón, mochila, etc.)* | *Cuoio di bovina, chiusura a scatto in alluminio, il guinzaglio può essere riposto in modo rapido e semplice, indipendentemente dalla lunghezza, con possibilità di fissaggio individuale (cintura, zaino, ecc.)* | *Okselæder, kliklås af aluminium, Snoren kan hurtigt og nemt gemmes væk, uanset længde, individuelle fastgørelsesmuligheder (bælte, rygsæk osv.)*

dunkelbraun | dark brown | marron foncé | marrón oscuro | marrone scuro | mørkebrun

69546 

schwarz | black | noir | negro | nero | sort

69547 

Halter VIBORG für Apple AirTag

Holder for Apple AirTag | Support pour Apple AirTag | Soporte para Apple AirTag | Supporto per Apple AirTag | Holder til Apple AirTag

Rindsleder, mit passgenauer Halterung für Apple AirTag (AirTag nicht im Lieferumfang enthalten), individuell einsetzbar | *Cow leather, with customised holder for Apple AirTag (AirTag not included), can be used individually* | Cuir de boeuf, avec support adapté pour Apple AirTag (AirTag non compris dans la livraison), utilisable individuellement | *Cuero de vacuno, con soporte personalizado para Apple AirTag (AirTag no incluido), puede utilizarse individualmente* | *Cuoio di bovina, con supporto personalizzato per Apple AirTag (AirTag non incluso), può essere utilizzato singolarmente* | *Okselæder, med skræddersyet holder til Apple AirTag (AirTag medfølger ikke), kan bruges individuelt*

cognac | cognac | cognac | coñac | cognac | cognac

207390 

schwarz | black | noir | negro | nero | sort

207395 



4,7 x 6,0 cm



**NEW
colour**

MADE
IN
GERMANY

■ 9 x 6 cm ■■■ 6 Stck. | pcs.

Halsband-Fliege PARIS

Collar bow tie | Nœud papillon de col | Pajarita de cuello | Cravatta a farfalla con collare | Butterfly

Rindsleder, einfache Befestigung am Halsband | *Cow leather, easy to attach to the collar* | Cuir de boeuf, fixation facile au collier | *Cuero de vacuno, fácil de sujetar al collar* | Cuoio di bovina, facile fissaggio al collare | *Okselæder, let fastgørelse til halsbånd*

rot | red | rouge | rojo | rosso | rød

69229

schwarz | black | noir | negro | nero | sort

207659





Reise & Transport

— *Travel & Transport* —

Die Produkte aus dieser Rubrik erleichtern den Transport des Hundes und lassen den Hundebesitzer jede Reise noch entspannter genießen. Bei HUNTER stehen die Faktoren Sicherheit und Komfort für Hund und Mensch an oberster Stelle. Praktische Utensilien, wie für Reisen mit dem Flugzeug geeignete Tragetaschen, Transportboxen und Hundedecken für den Einsatz im Auto, sowie reisetaugliche Futter- und Trinknapfe runden das Sortiment ab.

The products in this section simplify dog transport arrangements and allow the dog owner to relax and enjoy each trip. At HUNTER, safety and comfort for dog and owner have the highest priority. Practical equipment, including the carry bags which are ideal for travelling by plane, transport boxes and dog covers for use at exhibitions and in the car as well as food and water bowls which are suitable for travelling, top off the range.



■ 25 x 10 cm IIII
2 Stck. | pcs.

Reisenapf ROAD REFRESHER™

Travel bowl | Écuelle de voyage | Comedero de viaje | Ciotola da viaggio | Rejsefoderskål

Kunststoff, für Zuhause und unterwegs, dank integrierter Einlage auch während der Autofahrt kein Verschütten des Wassers | Plastic, can be used at home and outdoor, no water spillage, even during a car journey, thanks to the integrated insert | Plastique, à la maison et en déplacement, un élément incorporé permet de ne pas renverser d'eau en cours de trajet | Plástico, tanto para la casa como para la calle, gracias al depósito integrado, no se derramará ni una gota de agua ni siquiera cuando el vehículo esté en movimiento | Plastica, per l'utilizzo sia in casa che fuori casa, grazie al supporto integrato è possibile evitare la fuoriuscita dell'acqua durante il viaggio in macchina | Kunststof, til derhjemme og undervejs, takket vare integreret indlæg, så forekommer der heller ikke under bilkørslen vandspild

1,4 l 44442 

➔ für unterwegs mit Anti-Schwapp-Funktion
for travelling with anti-sloshing function

➔ während der Fahrt nutzbar
useable during the journey

➔ Klettvorrichtung am Napfboden
Velcro at the bottom of the bowl

➔ einfach auseinander- und zusammensteckbar
easy to take apart and put together



Der Reisenapf ROAD REFRESHER™ ermöglicht die optimale Versorgung des Hundes mit Wasser unterwegs und auf Reisen – auch während der Fahrt. Durch die ideale Form und die besondere Konstruktion des Napfes kann dieser mit Wasser gefüllt und im Fahrzeug ohne Risiko hingestellt werden, sodass das Tier jederzeit trinken kann. Eine integrierte Platte im Napf sorgt dafür, dass das Wasser auch bei Bewegung des Napfes nicht verschüttet wird. Zudem sorgen Klettverschlüsse an der Unterseite für einen stabilen Halt des Napfes. Der Reisenapf ROAD REFRESHER™ kann einfach auseinander- und wieder zusammengesteckt werden, sodass einer gründlichen Reinigung nichts im Wege steht. **Tipp: Der Reisenapf ist auch ideal für Zuhause geeignet, um unnötige Wasserpfützen um den Trinknapf herum zu vermeiden.**

*The travel bowl ROAD REFRESHER™ enables you to keep your pet ideally supplied with water when you are on the move – even during travelling. Due to its ideal shape and the special construction, the bowl can be filled with water and then safely placed within the vehicle so your pet can drink whenever it wants. An integrated layer ensures that no water is spilled even when the bowl moves. In addition, the velcro on the underside provides a stable stop for the bowl on carpet or in the boot. The travel bowl ROAD REFRESHER™ unit comes apart easily and quickly clicks back together, so that it is simple to clean it. **Tip: The Travel Bowl is also ideally suited for use at home in order to avoid water being spilled around the bowl.***





☞ IIII
350 / 750 ml 2 Stck. | pcs.

Silikon Reisenapf LIST

Silicone travel bowl | Gamelle de voyage en silicone | Cuenco de viaje de silicona | Ciotola da viaggio in silicone | Rejseskål i silikone

lebensmittelgeeignetes Silikon, platzsparend faltbar, mit Befestigungskarabiner, der kleine Napf kann als Deckel verwendet werden, spülmaschinenfest | *silicone material is suitable for use with foodstuffs, folds up to save space, with fastening hook, the small bowl can also be used as a cover, dishwasher-safe* | silicone appropriée aux produits alimentaires, pliante pour réduire l'encombrement, avec mousqueton de fixation, la petite écuelle peut être utilisée comme couvercle, peut être lavé au lave-vaisselle | *silicona adecuada para alimentos, plegable para ahorrar espacio, con mosquetón de sujeción, la ciotolina può essere utilizzata come coperchio, resistente al lavavajillas* | silicone adatto agli alimenti, struttura pieghevole salvaspazio, con moschettone per il fissaggio, el cuenco pequeño se puede utilizar como tapa, lavable en lavastoviglie | *levnedsmiddelegnet silikone, pladsbesparende, kan klappes sammen, med fastgørelseskarabiner, den lille madskål kan bruges som låg, tåler opvaskemaskine*

beige | tan | beige | beige | beige | beige

65135

rot | red | rouge | rojo | rosso | rød

65134



☞ IIII
750 / 750 ml 2 Stck. | pcs.

Silikon Reisenapf mit Tasche LIST

Silicone travel bowl with bag | Gamelle de voyage en silicone avec pochette | Cuenco de viaje de silicona con estuche | Ciotola da viaggio in silicone con custodia | Rejseskål i silikone med taske

lebensmittelgeeignetes Silikon, platzsparend faltbar, mit integrierter Reißverschluss tasche | *silicone material is suitable for use with foodstuffs, folds up to save space, with integrated zipper case* | silicone appropriée aux produits alimentaires, pliante pour réduire l'encombrement, avec sac à fermeture à glissière intégré | *silicona adecuada para alimentos, plegable para ahorrar espacio, con bolsillo de cremallera integrado* | silicone adatto agli alimenti, struttura pieghevole salvaspazio, con borsetta con cerniera integrata Silikon | *levnedsmiddelegnet silikone, pladsbesparende, kan klappes sammen, med integreret lynlåstaske*

beige | tan | beige | beige | beige | beige

65137

rot | red | rouge | rojo | rosso | rød

65136





⇌ 550 ml ☐ 20 cm |||| 2 Stck. | pcs.



⇌ 590 ml ☐ 15 x 12 x 5 cm |||| 2 Stck. | pcs.

Outdoor Trinkflasche mit Silikonnapf LIST

Outdoor drinking bottle with silicone bowl | Gourde de voyage avec gamelle en silicone | Botella para exterior con cuenco de silicona | Borraccia da esterno con ciotola in silicone | Udendørs drikeflaske med skål i silikone

lebensmittelgeeignetes Silikon, Schüttvorrichtung auch separat anwendbar auf handelsübliche Flaschengewindegrößen | *silicone material is suitable for use with foodstuffs, pouring device can also be used separately on bottles with standard sized threading* | silicone appropriée aux produits alimentaires, système verseur également utilisable séparément sur les filetages standards des bouteilles du commerce | *silicona adecuada para alimentos, el sistema para verter liquido puede utilizarse asimismo por separado en botellas de tamaño convencional* | silicone adatto agli alimenti, ciotola utilizzabile anche separatamente con bottiglie di dimensioni comuni | *levnedsmiddelegnet silikone, hældeindretning, kan også anvendes separat på konventionelle flaskegevindstørrelser*

beige | tan | beige | beige | beige | beige

65129

rot | red | rouge | rojo | rosso | rød

65128

Silikon Falt-Reisenapf LIST

Silicone fold travel bowl | Gamelle de voyage pliable en silicone | Cuenco de viaje plegable de silicona | Ciotola pieghevole da viaggio in silicone | Rejse-foldeskål i silikone

lebensmittelgeeignetes Silikon, platzsparend faltbar, spülmaschinenfest | *silicone material is suitable for use with foodstuffs, folds up to save space, dishwasher-safe* | silicone appropriée aux produits alimentaires, pliante pour réduire l'encombrement, peut être lavé au lave-vaisselle | *silicona adecuada para alimentos, plegable para ahorrar espacio, resistente al lavavajillas* | silicone adatto agli alimenti, struttura pieghevole salvaspazio, lavabile in lavastoviglie | *levnedsmiddelegnet silikone, pladsbesparende, kan klappes sammen, tåler opvaskemaskine*

beige | tan | beige | beige | beige | beige

65131

rot | red | rouge | rojo | rosso | rød

65130



Rockford-Family

Hunde-Reisedecke ROCKFORD

Travel blanket for dogs | Couverture de voyage pour chiens | Manta de viaje para perros | Coperta da viaggio per cani | Hund rejse tæppe

Polyester, Oberseite mit sehr weichem Plüsch, kann zusammengerollt, durch Klettstreifen fixiert und platzsparend transportiert werden, mit Tragegriff, bei 30°C waschbar | Polyester, top side with very soft plush, can be rolled up, secured with velcro and easily transported, with handle, washable at 30°C | Polyester, face supérieure en peluche très douce, peut être roulée sur elle-même, fixée avec du velcro et transporter de manière peu encombrante, avec poignée, lavable à 30 °C | Poliéster, top con felpa muy suave, se puede enrollar, fijar con velcro y transportar ahorrando espacio, con asa, lavable a 30 °C | Poliester, top in felpato molto morbido, può essere arrotolata, fissato con cinghie di velcro e trasportato con un minimo ingombro, con maniglia, lavabile a 30°C | Polyester, top med meget blødt plys, kan rulles sammen, fastgøres med velcrobånd og transporteres på en pladsbesparende måde, med håndtag, vaskbar ved 30 °C

anthrazit/hellgrau | anthracite/light grey | anthracite/gris clair | anthracite/gris claro | anthracite/grigio chiaro | antracit/lysegrå

L 69854



XL 200334



↕	☐
L	100 x 70 cm
XL	120 x 80 cm







145 x 150 cm

Rückbank-Schutzdecke HAMILTON

Rear seat cover | Couverture de protection pour siège arrière | Manta para el coche (asiento trasero) | Coperta coprisedile per sedili posteriori | Skånebetræk til bilens bagsæde

Polyester/Baumwolle, Sitzfläche mit Polyester-Füllung, verstellbare Gurte zum Anbringen an den Kopfstützen, schützt das Auto vor Schmutz und Haaren, mit Schlitz für Autosicherheitsgeschirre, mit praktischer Tasche, waschbar bei 95 °C | Polyester/Cotton, cushioned with polyester filling, adjustable belts for fastening to the headrests, protects the car from dirt and hair, with slits for car seatbelts, with practical bag, washable at 95 °C | Polyester/coton, siège rembourré de polyester, sangles réglables pour fixation aux appuis-tête, protège la voiture de la saleté et des poils, avec fentes pour les harnais de sécurité pour automobile, poches pratiques, lavable à 95 °C | Poliéster/algodón, asiento con relleno de poliéster, correas ajustables para fijar a los reposacabezas, protege el coche de suciedad y pelos, con ranuras para arneses de coches, con un práctico bolsillo, lavable a 95 °C | Poliestere/cotone, superficie di seduta con imbottitura in poliester, cinghie regolabili per il fissaggio ai poggiatesta, protegge l'auto da sporco e capelli, con fessure per le cinture di sicurezza, con pratica tasca, lavabile a 95 °C | Polyester/Bomuld, Sideflade med polyesterfyld, indstillelige remme til anbringelse på nakkestøtterne, beskytter bilen mod snavs og hård, med slider til bilens sikkerhedssele, med praktisk lomme, kan vaskes ved 95 °C

schwarz | black | noir | negro | nero | sort

68197 



100 x 65 cm

Kofferraum-Schutzdecke HAMILTON

Car blanket for protection for the trunk | Couverture de protection pour le coffre de la voiture | Manta de protección para el maletero del coche | Coperta protettiva per portabagagli | Teppe til bagagerum

Polyester/Baumwolle, Sitzfläche mit Polyester-Füllung, verstellbare Gurte zum Anbringen an den Kopfstützen, schützt den Kofferraum vor Schmutz und Haaren, waschbar bei 95 °C | Polyester/Cotton, cushioned with polyester filling, adjustable belts for fastening to the headrests, protects the car boot from dirt and hair, washable at 95 °C | Polyester/coton, siège rembourré de polyester, sangles réglables pour fixation aux appuis-tête, protège le coffre de la saleté et des poils, lavable à 95 °C | Poliéster/algodón, asiento con relleno de poliéster, correas regulables para fijar a los reposacabezas, protege el maletero de suciedad y pelos, lavable a 95 °C | Poliestere/cotone, superficie di seduta con imbottitura in poliester, cinghie regolabili per il fissaggio ai poggiatesta, protegge il portabagagli da sporco e capelli, lavabile a 95 °C | Polyester/Bomuld, Sideflade med polyesterfyld, indstillelige gjorde til anbringelse på nakkestøtterne, beskytter bagagerummet mod snavs og hård, kan vaskes ved 95 °C

schwarz | black | noir | negro | nero | sort

68196 



■
120 x 70 cm

Der besondere Clou dieser Hundedecke: Sie ist bei 95°C waschbar. Durch die Kochwäsche werden alle Keime und Parasiten (Hausstaubmilben o.ä.) zuverlässig aus dem Inneren des Gewebes ausgewaschen und abgetötet. Das sorgt für ultimative Reinheit und Hygiene. Darüber hinaus sorgt das Baumwollmischgewebe für eine weiche Unterlage, die außerdem noch strapazierfähig und pflegeleicht ist. Ein gemütlicher, universell einsetzbarer und leicht zu verstauender Allrounder für jede Gelegenheit.

The special highlight of this dog blanket: it is washable at 95 °C. A high-temperature wash will reliably remove all germs and parasites (dust mites and similar creatures) from the blanket's interior and kill them. This ensures optimal cleanliness and hygiene. What's more, the cotton blend creates a soft surface that is also durable and easy to clean. A comfy all-rounder that can be used anywhere at any time and is easy to store.

Hundedecke HAMILTON

Dog blanket | Couverture pour chiens | Manta de perro | Coperta per cani | Hundeteppe

Baumwolle / Polyester, bei 95°C waschbar | *Cotton / Polyester, washable at 95°C* | Coton / Polyester, lavable à 95°C | *Algodón / Poliéster, lavable a 95°C* | Cotone / Poliestere, lavabile a 95°C | *Bomuld / Polyester, vaskbar ved 95°C*

grau | grey | gris | gris | grigio | grå

66220 



hygienisch
hygienic



robust
durable



universell einsetzbar
universally usable





Rückbank-Schutzdecke

Rear seat cover | Couverture de protection pour siège arrière | Manta para el coche (asiento trasero) | Coperta copriesedile per sedili posteriori | Skånebetræk til bilens bagsæde

Polyester, schützt das Auto vor Schmutz und Haaren, mit Reißverschluss zur Teilung, mit Öffnungen für Gurte, für fast alle Fahrzeugtypen geeignet | Polyester, protects the car from dirt and hair, with zip for division, with openings for belt lashing, suitable for almost all vehicle types | Polyester, protège la voiture de la saleté et des poils, avec fermeture éclair pour la séparation, avec ouvertures pour boucles de ceinture de sécurité, adapté à presque tous les véhicules | Poliéster, protege el coche de la suciedad y los pelos del perro, con cremallera de separación, con orificios para enganche en cinturón, adecuado para casi todos los tipos de vehículos | Poliester, protegge l'auto dalla sporcizia e dal pelo, con cerniera per dividere, con aperture per i fermi della cintura, adatto a quasi tutti i tipi di veicoli | Polyester, beskytter bilen mod snavs og hår, med lynlås til deling, med åbninger til selepiske, egnet til næsten alle fartøjstyper

92424 

■
145 x 142 cm



Display Bürste MARIENKÄFER

Display Brush | Support Brosse | Soporte Cepillo | Espositore Spazzola | Display Børster

Kunststoff, Gummiborsten in V-Form, zum Entfernen von Tierhaaren an Kleidung oder Polstern durch statische Aufladung der Gummiborsten, auch zur Massage geeignet, 15 Bürsten im praktischen Display | Plastic, rubber bristles in V-shape, static charges from rubber bristles remove animal hairs on clothes or upholstery, also well suited for massages, 15 brushes in a practical display | Plastique, brosses en caoutchouc en forme de V, pour éliminer les poils d'animaux sur les vêtements ou les coussins grâce à la charge statique de la brosse en caoutchouc, également idéale pour les massages, 15 petites brosses dans un conditionnement pratique | Plástico, cerdas de goma en forma de V, para retirar el pelo de mascotas de la ropa o de tapizados por cargas estáticas de cerdas de goma, también indicado para masajear, 15 cepillos en práctico mostrador | Plastica, setole in gomma disposte a V, rimuove i peli di animali da vestiti e imbottiti grazie alla carica elettrostatica delle setole in gomma, indicato anche per massaggiare, 15 spazzole nel pratico display | Kunststoff, gummibørster i V-form, til fjernelse af dyrehår på beklædning eller polstring ved hjælp af statisk opladning af gummibørster, samt egnet til massage, 15 børster i praktisk display

10 cm 44507 

MADE
IN
GERMANY 

III
15/Display

Magic V

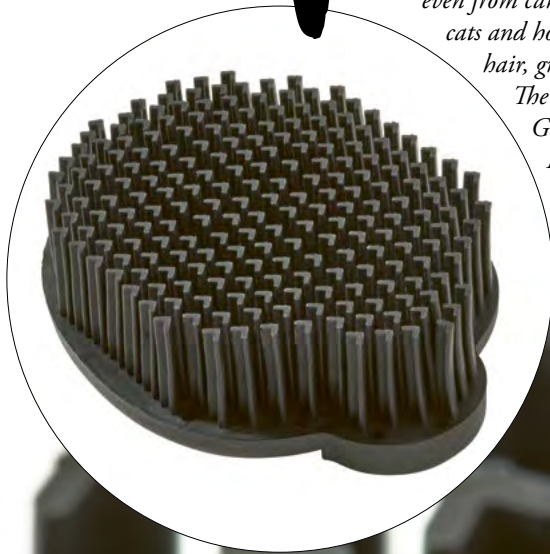

Dank der flexiblen, in V-Form angeordneten Gummiborsten eignen sich die praktischen Bürsten von HUNTER ideal zum Entfernen von Tierhaaren – auch aus Teppichen und Möbeln. Hervorragend einsetzbar sind sie auch zur Fellpflege bei Hund, Katze und Pferd. Durch die statische Aufladung der V-Borsten aus Gummi werden Tierhaare, Schmutz und Staub mühelos von unterschiedlichsten Materialien entfernt. Die praktischen Bürsten sind »Made in Germany« und zeichnen sich durch verschiedene Details aus: MARIENKÄFER und SCHMETTERLING sind z.B. besonders handlich und eignen sich bestens für die Mitnahme auf Reisen. **Gebrauchshinweis: Bürsten Sie immer in das offene V, um die bestmögliche Wirkung zu erzielen.**

Thanks to the flexible rubber bristles, which are arranged in a V shape, the practical brushes from HUNTER are suitable for removing animal hair – even from carpets and furniture. They are also really good for grooming dogs, cats and horses. Thanks to the static charge of the rubber V bristles, animal hair, grime and dust can be effortlessly removed from various materials.

The practical brushes are »Made in

Germany« and are characterised by various details: the

MARIENKÄFER and the SCHMETTERLING are, for example, particularly handy and are ideally suited for taking along a trip. In-

structions for use: Always brush

**with the V open to get
the best results.**

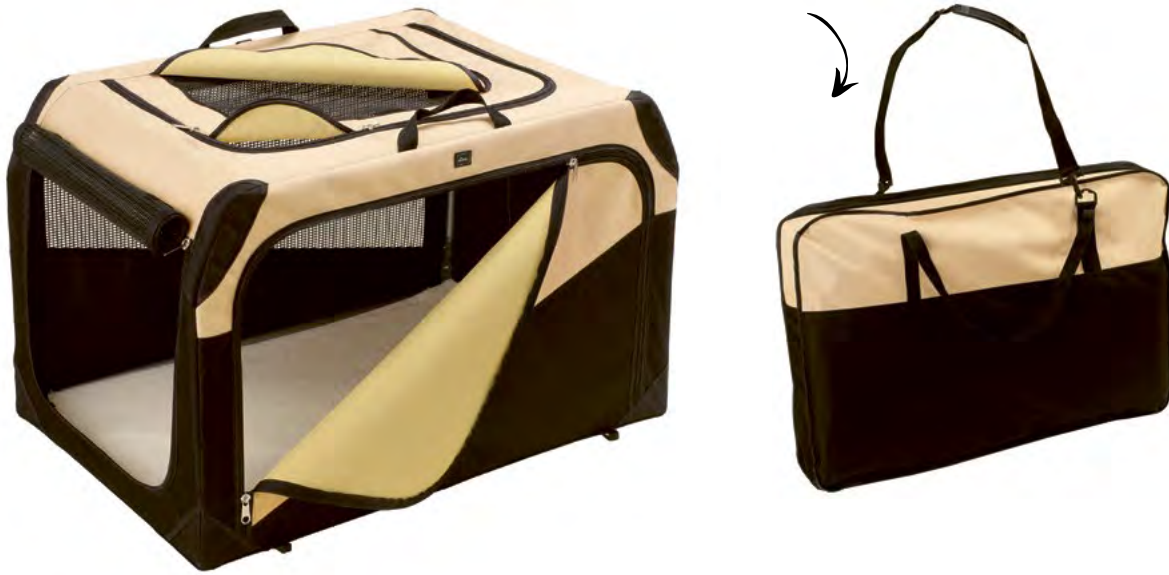

praktische Tragetasche
practical carrier bag



Nylon, mit Reißverschluss, abwaschbar, mit integrierter Matte, mit Außentasche zum Verstauen von Zubehör, mit Tragetasche | *Nylon, with zipper, wipeable, with integrated mat, with outside pocket for stowing of accessories, with carrier bag* | Nylon, avec fermeture à glissière, essuyable, avec tapis intégré, avec pochette à l'extérieur pour ranger des accessoires, avec étui de transport | *Nylon, con cremallera, lavable, con alfombrilla integrada, con bolsillo exterior para guardar accesorios, con bolsa de transporte* | Nylon, con chiusura lampo, lavabile, con fondo integrato, con tasca esterna per gli accessori, con borsa da trasporto | *Nylon, med lynlås, afvaskelige, med integreret måtte, med udvendig lomme*

Faltbare Hundebox

Foldable dog box | *Cage de transport pliante pour chien* | *Trasportín plegable para perro* | *Box per cani pieghevole* | *Foldbar hundeboks*

S	44956		M	44957	
L	44958		XL	44959	





Nylon, besonders leicht, sehr schnell aufzubauen, leichtes Aluminium-Gestell, mit Reißverschluss, abwaschbar, mit integrierter Matte, mit Außentasche zum Verstauen von Zubehör, mit Tragetasche | *Nylon, particularly lightweight, very quick to assemble, lightweight aluminum frame, with zipper, wipeable, with integrated mat, with outside pocket for stowing of accessories, with carrier bag* | Nylon, particulièrement léger, montage très rapide, support en aluminium léger, avec fermeture à glissière, essuyable, avec tapis intégré, avec pochette à l'extérieur pour ranger des accessoires, avec étui de transport | *Nylon, muy ligero, montaje muy rápido, armazón de aluminio ligero, con cremallera, lavable, con alfombrilla integrada, con bolsillo exterior para guardar accesorios, con bolsa de transporte* | Nylon, estremamente leggero, montaggio rapido, telaio in alluminio leggera, con chiusura lampo, lavabile, con fondo integrato, con tasca esterna per gli accessori, con borsa da trasporto | *Nylon, særlig let, meget hurtigt at bygge op, letvægts alu-stel, med lynlås, afvaskelige, med integreret måtte, med udvendig lomme til tilbehør, med taske.*

Faltbare Hundebox mit Aluminium-Gestell

Foldable dog box with aluminium frame | Cage de transport pliante pour chien avec cadre en aluminium | Trasportin plegable para perro con marco de aluminio | Box per cani pieghevole con telaio in alluminio | Foldbar hundeboks med aluminiumsramme

S	62583		M	62584	
L	62585		XL	62589	

leichtes Aluminium-Gestell *lightweight aluminum frame*



praktische Tragetasche
practical carrier bag

Auf Reisen wie Zuhause – Stilvoll abgestimmte Accessoires für elegante Abenteuer!

*Travelling like at home - Stylishly coordinated
accessories for elegant adventures!*

Ob Hunde-Tragetasche mit integrierter Decke, 2-in-1 Autositz und Reisebett, Crossbody-Tasche mit Decke oder die faltbare Hunde-Reisedecke zum Umhängen – SEOUL bietet maximalen Komfort und Flexibilität. Jedes Produkt ist darauf ausgelegt, den Alltag einfacher zu gestalten und dem Hund unterwegs eine gemütliche Auszeit zu bieten. Mit SEOUL vereinen sich Eleganz und Funktion in einem modernen, urbanen Look – perfekt für Hundehalter, die nicht nur Wert auf Ästhetik, sondern auch auf praktische Details legen.

Whether it's a dog carrier bag with integrated blanket, 2-in-1 car seat and travel bed, crossbody bag with blanket or the foldable dog travel blanket to hang around the neck - SEOUL offers maximum comfort and flexibility. Each product is designed to make everyday life easier and offer your dog a cosy break when travelling. SEOUL combines elegance and function in a modern, urban look - perfect for dog owners who not only value aesthetics, but also practical details.



Seoul





2-IN-1

2-in-1 Hunde-Tragetasche und Decke SEOUL

2-in-1 dog carrier bag and blanket | Sac de transport pour chien et couverture 2 en 2 | Bolsa y manta 2 en 1 para perros | Borsa e coperta per cani 2 in 2 | 2-i-1 hundetaske og tæppe

Nylon, praktische Tragetasche mit herausnehmbarer Einlage (waschbar bei 30°C), Einlage auch als separate Decke verwendbar, Gurt mit Karabiner zur Sicherung des Tieres, Abdeckung mit Reißverschluss, Abdeckung kann in geöffnetem Zustand mit Klettverschluss fixiert werden, um ein Zuklappen zu verhindern, praktische Außentasche, bis max. 7 kg belastbar, waschbar bei 30°C | Nylon, practical carrying bag with removable insert (washable at 30°C), insert can also be used as a separate blanket, strap with carabiner to secure the animal, cover with zip, cover can be secured with velcro when open, practical outer pocket, max. load capacity 7 kg, washable at 30°C | Nylon, sac de transport pratique avec doublure amovible (lavable à 30°C), doublure également utilisable comme couverture séparée, sangle avec mousqueton pour sécuriser l'animal, couverture avec fermeture éclair, le couvercle peut être fixé à l'aide d'une bande velcro lorsqu'il est ouvert, poche extérieure pratique, supporte une charge maximale de 7 kg, lavable à 30°C | Nylon, práctica bolsa de transporte con inserto extraíble (lavable a 30°C), el inserto también se puede utilizar como manta independiente, correa con mosquetón para sujetar al animal, tapa con cremallera, la tapa puede fijarse con velcro cuando está abierta, práctico bolsillo exterior, capacidad de carga máx. 7 kg, lavable a 30°C | Nylon, pratica borsa da trasporto con inserto rimovibile (lavabile a 30°C), inserto utilizzabile anche come coperta separata, cinghia con moschettone per assicurare l'animale, copertura con cerniera, il coperchio può essere fissato con il velcro quando è aperto, pratica tasca esterna, portata massima 7 kg, lavabile a 30°C | Nylon, praktisk bærer taske med udtagelig indsats (vaskbar ved 30°C), indsatsen kan også bruges som separat tæppe, strop med karabinhage til at sikre dyret, dækslet kan fastgøres med velcro, når det er åbent, når det er åbent, for at forhindre, at det lukker, praktisk yderlomme, maks. belastningskapacitet 7 kg, vaskbar ved 30°C

greige

207447



Herausnehmbare Einlage als separate Decke verwendbar

Removable insert can be used as a separate blanket



55 x 40 cm



45 x 22 x 24 cm



max. 7,0 kg



2-IN-1



50 x 50 x 30 cm

2-in-1 Autositz und Reisebett SEOUL

2-in-1 dog carrier bag and blanket | Sac de transport pour chien et couverture 2 en 2 | Bolsa y manta 2 en 1 para perros | Borsa e coperta per cani 2 in 2 | 2-i-1 hundetaske og tæppe

Nylon, zum sicheren Transport des Tieres auf dem Autositz, auch als Reisebett verwendbar, zweifache Befestigung am Autositz möglich, Gurt mit Karabiner zur Sicherung des Tieres, erhöhter und dick gepolsterter Rand, waschbar bei 30°C | *Nylon, for safe transport of the animal on the car seat, can also be used as a travel cot, can be attached to the car seat in two ways, strap with carabiner to secure the animal, raised and thickly padded edge, washable at 30°C* | Nylon, pour transporter l'animal en toute sécurité sur le siège-auto, peut également être utilisé comme lit de voyage, double fixation possible au siège-auto, sangle avec mousqueton pour sécuriser l'animal, bord surélevé et rembourré épais, lavable à 30°C | *Nylon, para el transporte seguro del animal en el asiento del coche, también se puede utilizar como cuna de viaje, se puede fijar al asiento del coche de dos maneras, correa con mosquetón para asegurar al animal, borde elevado y acolchado grueso, lavable a 30°C* | Nylon, per un trasporto sicuro dell'animale sul sedile dell'auto, utilizzabile anche come letto da viaggio, può essere fissato al sedile dell'auto in due modi, cinghia con moschettone per assicurare l'animale, bordo rialzato e fittamente imbottito, lavabile a 30°C | *Nylon, til sikker transport af dyret på autostolen, kan også bruges som rejseseng, kan fastgøres til autostolen på to måder, strop med karabinhage til fastgørelse af dyret, hævet og tykt polstret kant, vaskbar ved 30°C*

greige

207445 



Zweifache Befestigung am Autositz möglich
Can be attached to the car seat in two ways



Gurt mit Karabiner zur Sicherung des Tieres
Strap with carabiner to secure the animal

Erhöhter und dick gepolsterter Rand
Raised and thickly padded edge



Gurte mit HUNTER-Schriftzug
Straps with HUNTER lettering



Staufach für Zubehör
Storage compartment for accessories





⇌ 
L 96 x 70 cm



Mit Klettverschlüssen zum schnellen Zusammenfalten
With Velcro fasteners for quick folding

Faltbare Hunde-Reisedecke SEOUL

Foldable dog travel blanket | *Couverture de voyage pliable pour chiens* | *Manta de viaje plegable para perros* | *Coperta da viaggio pieghevole per cani* | *Sammenklappeligt reiseteppe til hunde*

Polyester, faltbare Reisedecke für unterwegs, wasserfeste Unterseite, weiche Liegefläche, mit Klettverschlüssen zum schnellen Zusammenfalten, stufenlos verstellbarer Schultergurt, waschbar bei 30°C | *Polyester, foldable travel blanket for travelling, waterproof underside, soft lying surface, with Velcro fasteners for quick folding, infinitely adjustable shoulder strap, washable at 30°C* | Polyester, couverture de voyage pliable pour les déplacements, dessous imperméable, surface de couchage douce, avec fermetures velcro pour un pliage rapide, bandoulière réglable en continu, lavable à 30°C | *Poliéster, manta de viaje plegable para viajar, parte inferior impermeable, superficie suave para tumbarse, con cierres de velcro para plegarla rápidamente, correa para el hombro ajustable sin escalonamientos, lavable a 30°C* | Poliestere, coperta pieghevole da viaggio, fondo impermeabile, morbida superficie di appoggio, con chiusure in velcro per un rapido ripiegamento, tracolla regolabile in continuo, lavabile a 30°. | *Polyester, sammenklappelig reiseteppe til rejser, vandtæt underside, blød liggeflade, med velcrolukning til hurtig sammenfoldning, trinløs justerbar skulderrem, vaskbar ved 30°C*

greige

207441 



Wasserfeste Unterseite
Waterproof underside



Staufach
Storage compartments



inkl. Decke
incl. blanket



70 x 50 cm

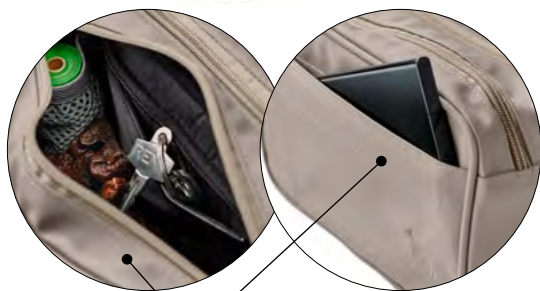

Staufächer
Storage compartments

 21 x 13 x 7 cm

**Dehnfalte zur Vergrößerung
des Stauraums**
Stretch pleat to enlarge storage

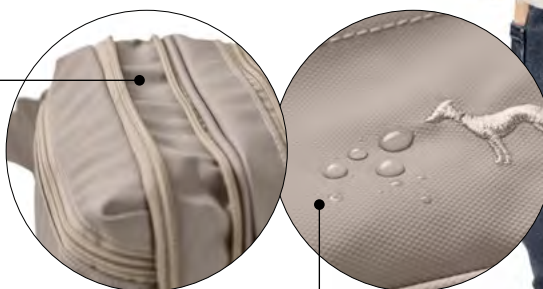

Schmutz- und wasserabweisend
Dirt and water repellent

Crossbody-Tasche inkl. Decke SEOUL

Crossbody bag incl. blanket | Sac crossbody avec couverture | Bolsa cruzada con manta | Borsa a tracolla con coperta | Crossbody-taske inkl. teppe

Polyester, abwaschbar, auch als Bauchtasche verwendbar, inkl. passender Decke, mehrere Staufächer, stufenlos verstellbarer Schultergurt, Dehnfalte zur Vergrößerung der Tasche, integrierter Kotbeutelspender | *Polyester, washable, can also be used as a bum bag, incl. matching blanket, several storage compartments, infinitely adjustable shoulder strap, stretch pleat to enlarge the bag, integrated poo bag dispenser* | Polyester, lavable, également utilisable comme sac ventral, couverture assortie incluse, plusieurs compartiments de rangement, bandoulière réglable en continu, soufflet d'extension pour agrandir le sac, distributeur de sacs à crottes intégré | *Poliéster, lavable, también se puede utilizar como bolsa para el culito, incluye manta a juego, varios compartimentos para guardar cosas, correa para el hombro ajustable sin escalonamientos, pliegue extensible para ampliar la bolsa, dispensador de bolsas para la caca integrado* | Poliestere, lavabile, utilizzabile anche come marsupio, inclusa coperta coordinata, diversi scomparti, tracolla regolabile in continuo, piega elastica per allargare la borsa, distributore di sacchetti per la cacca integrato | *Polyester, vaskbar, kan også bruges som bum bag, inkl. matchende tæppe, flere opbevaringsrum, trinløs justerbar skulderrem, strekfolder til at forstørre tasken, integreret lorteposedispenser*

greige

207439 



Integrierter Kotbeutelspender
Integrated poo bag dispenser





Mit gepolsterten, verstellbaren Schulterriemen und Brustgurt

With padded, adjustable shoulder straps and chest strap



30 x 22 x 45 cm



max. 6,5 kg

Flugtasche & Rucksack MILES

Flight Bag & Backpack | Sac de vol & sac à dos | Bolsa y mochila de vuelo | Borsa da volo e zaino | Flyvetaske og rygsæk

Polyester/Eisen, große Einstiegsöffnung (oben), optimale Belüftung dank hohem Mesh-Anteil, mit herausnehmbarem und waschbarer Einlage aus Lammfell-Imitat, mit Karabiner (innen) zur Sicherung des Tieres, mit praktischen Außentaschen aus elastischem Material, mit gepolsterten, verstellbaren Schulterriemen und Brustgurt, mit gepolsterter Rückenpartie und praktischer Reißverschluss tasche für wichtige Dokumente, mit leichtem Karabiner (außen) zur Befestigung weiteren Zubehörs, Bodenschale mittels Reißverschluss abnehmbar, Befestigung an einem Trolleygestänge möglich, Handwäsche, bis max. 6,5 kg belastbar | Polyester/Iron, large entry opening (top), optimum ventilation thanks to high mesh content, with removable and washable insert made of imitation lambskin, with carabiner (inside) to secure the animal, with practical outside pockets made of elastic material, with padded, adjustable shoulder straps and chest strap, with padded back and practical zipped pocket for important documents, with light carabiner (outside) for attaching further accessories, bottom tray can be removed by means of zip, can be attached to a trolley pole, hand washable, max. load of 6.5 kg | Polyester/Fer, grande ouverture d'accès (en haut), aération optimale grâce à une forte proportion de mesh, avec doublure amovible et lavable en imitation fourrure d'agneau, avec mousqueton (intérieur) pour sécuriser l'animal, avec poches extérieures pratiques en matériau élastique, avec bretelles rembourrées et réglables et sangle de poitrine, avec partie dorsale rembourrée et poche zippée pratique pour les documents importants, avec mousqueton léger (extérieur) pour fixer d'autres accessoires, coque de fond amovible au moyen d'une fermeture à glissière, fixation possible à une tige de trolley, lavage à la main, charge maximale de 6,5 kg | Poliéster/Hierro, gran abertura de entrada (superior), óptima ventilación gracias al alto contenido de malla, con inserción extraíble y lavable de imitación de piel de cordero, con mosquetón (interior) para asegurar el animal, con prácticos bolsillos exteriores de material elástico, con correas acolchadas y ajustables para los hombros y correa para el pecho, con sección de la espalda acolchada y práctico bolsillo con cremallera para los documentos importantes, con mosquetón ligero (exterior) para asegurar otros accesorios, bandeja inferior extraíble mediante cremallera, puede fijarse a un poste de la carretilla, lavable a mano, puede cargarse hasta un máximo de 6,5 kg | Poliestere/Ferro, grande apertura d'entrata (in alto), ventilazione ottimale grazie all'alto contenuto di rete, con inserto rimovibile e lavabile in finta pelle d'agnello, con moschettone (interno) per assicurare l'animale, con pratiche tasche esterne in materiale elastico, con spallacci imbottiti e regolabili e fascia toracica, con parte posteriore imbottita e pratica tasca con cerniera per documenti importanti, con moschettone leggero (esterno) per fissare altri accessori, vassoio inferiore rimovibile tramite cerniera, può essere fissato a un'asta del trolley, lavabile a mano, può essere caricato fino a max. 6,5 kg | Polyester/Jern, stor indgangsåbning (øverst), optimal ventilation takket være et højt netindhold, med udtagelig og vaskbar indsats af imiteret lammeskind, med karabinhage (indvendigt) til fastgørelse af dyret, med praktiske udvendige lommer af elastisk materiale, med polstrede, justerbare skulderremme og brystrem, med polstret rygparti og praktisk lynlås-lomme til vigtige dokumenter, med let karabinhage (udenpå) til fastgørelse af yderligere tilbehør, bundbakke kan fjernes ved hjælp af lynlås, kan fastgøres til en trolley-stang, håndvaskbar, kan belastes med op til maks. 6,5 kg

schwarz | black | noir | negro | nero | sort

69346





Ideal für Flugreisen

Optimal als Handgepäck im Flugzeug geeignet, entspricht den Empfehlungen der IATA (International Air Transport Association). Zudem ist MILES zur Befestigung an einem Trolleygestänge geeignet.

Ideal for air travel. Ideally suited as hand luggage on planes, complies with IATA (International Air Transport Association) recommendations. MILES is also suitable for attachment to a trolley pole.



Gepolsterte Sitz- und Liegefläche

Der Rucksack lässt sich liegend flach unter dem Flugzeugsitz verstauen. Die Bodenschale ist abnehmbar.

Upholstered seat and lying surface. The backpack stows flat under the aircraft seat when lying down. The bottom tray is removable.

Mit Rundumblick dank »Panoramafenster«

Um alles im Blick zu haben und die Umgebung mit allen Sinnen wahrnehmen zu können, recken Vierbeiner ihren Kopf gern aus dem Fenster. Das »Panoramafenster« mit 360°-Rundumblick von MILES vereint beste Sicht mit größtmöglicher Sicherheit – damit auf Neugierde kein Sturz folgt.

With all-round view thanks to »Panorama window«. In order to have everything in view and to be able to perceive the surroundings with all their senses, four-legged friends like to stick their heads out of the window. The »Panorama window« with 360° all-round view from MILES combines the best view with the greatest possible safety - so that curiosity is not followed by a fall.





30 x 20 x 30 cm max. 6,0 kg

Rucksack/Tragetasche KANGAROO

Backpack/Carry bag | Sac à dos/Sac de transport | Mochila/Bolsa | Zino/Shopper | Rygsæk/Bæretaske

Polyester, mit Nylongurt und kleinem Karabiner zur Sicherung des Tieres, die Höhe des Innenraums kann mittels Reißverschluss individuell eingestellt werden, mit verstellbaren und gepolsterten Schulterriemen sowie Bauchgurt, waschbar bei 30°C, bis max. 6,0 kg belastbar | Polyester, with nylon strap and small karabiner to secure the animal, the height of the internal space can be adjusted individually using a zip, with adjustable and padded shoulder strap and waist strap, washable at 30°C, up to a weight of 6.0 kg | Polyester, avec sangle en nylon et petit mousqueton pour attacher l'animal, la hauteur de l'intérieur du sac peut être réglée individuellement au moyen de la fermeture à glissière, avec bretelles rembourrées réglables et ceinture ventrale, lavable à 30°C, allant jusqu'à 6,0 kg | Poliéster, con cinturón de nylon y un pequeño mosquetón para la seguridad del animal, espacio interior ajustable de forma individual mediante cremallera, con cinturón y correas ajustables y forradas, lavable a 30°C, hasta 6,0 kg de peso | Poliester, con cinghia in nylon e piccolo moschettone per la sicurezza del vostro animale, altezza interna regolabile individualmente grazie alla cerniera lampo, dotato di spallacci imbottiti e cintura addominale, lavabile a 30°C, peso massimo di 6,0 kg | Polyester, med nylonrem og lille karabiner til sikring af dyret, højden i taskens indre kan indstilles individuelt ved hjælp af en lynlås, med indstillelig og polstrede skulderremme, samt maverem, vaskbar ved 30°C, vægt på op til 6,0 kg

beige | tan | beige | beige | beige | beige

46018 

Bessere Gewichtsverteilung durch individuell einstellbare Gurte
Better weight distribution due to individually adjustable strap



Nylongurt mit Karabiner zur Sicherung des Tieres im Inneren
Inside nylon strap with carabiner makes it possible to secure the pet



Körpernahe Trageweise vor dem Bauch
Carrying position close to the body

Optimale Belüftungsöffnungen
Openings for optimum ventilation



1. Rucksack | Backpack
2. Tragetasche | Carry bag
3. Reisebett | Travel bed



35 x 20 x 40 cm max. 8,0 kg

Rucksack/Tragetasche TAYLOR

Backpack/Carry bag | Sac à dos/Sac de transport | Mochila/Bolsa | Zino/Shopper | Rygsæk/Bæretaske

PU/Polyester, abwaschbar, 3-in-1: als Rucksack, praktische Tragetasche und Reisebett verwendbar, mit stufenlos verstellbaren Schulter- und Bauchriemen, mit praktischen Außentaschen, bis max. 8,0 kg belastbar | PU/Polyester, washable, 3-in-1: can be used as a backpack, practical carry bag and travel bed, with continuously adjustable shoulder and belly straps, with practical outer pockets, up to a weight of 8.0 kg | PU/Polyester, lavable, 3-en-1: peut être utilisé comme sac à dos, sac de transport pratique et lit de voyage, avec bretelles et sangles ventrales réglables en continu, avec poches extérieures pratiques, allant jusqu'à 8,0 kg | PU/Poliéster, lavable, 3-en-1: puede usarse como mochila, como práctica bolsa de transporte o como cama de viaje, con correas ajustables para hombros y cintura, con práctico bolsillo exterior, hasta 8,0 kg de peso | PU/Poliester, lavabile, 3-in-1: si può utilizzare come zaino, pratica borsa trasportino e lettino da viaggio, con tracolla e cinghia addominale a regolazione continua, con pratiche tasche esterne, peso massimo di 8,0 kg | PU/Polyester, kan vaskes indvendigt, 3-i-1: kan anvendes som rygsæk, praktisk bæretaske og rejseseng, med trinløs skulder- og maverem, med praktiske yderlommer, vægt på op til 8,0 kg

rot | red | rouge | rojo | rosso | rød



67558 

blau | blue | bleu | azul | blu | blå

67559 





 40 x 20 x 42 cm
  max. 7,0 kg



Rucksack ORLANDO

Backpack | Sac à dos | Mochila | Zino | Rygsæk

Nylon, große Einstiegsöffnung (vorn), mit herausnehmbarer und abwaschbarer Einlage aus Lammfell-Imitat, mit Karabiner zur Sicherung des Tieres, mit praktischen Außentaschen, mit reflektierenden Elementen, mit gepolsterten und verstellbaren Schulterriemen, bis max. 7 kg belastbar | Nylon, large access opening (front), with removable washable imitation lambskin inlay, with carabiner to secure the animal, with dog waste bag carrier, with practical exterior pockets, with reflective elements, with padded adjustable shoulder straps, max. load of 7 kg | Nylon, grande ouverture d'accès (à l'avant), avec fond amovible et lavable en fourrure d'agneau synthétique, mousqueton pour la sécurité de l'animal, poches extérieures pratiques, éléments réfléchissants, bretelles rembourrées et réglables, capacité de charge jusqu'à 7 kg max. | Nylon, amplia abertura de entrada (frontal), con base extraíble y lavable de imitación de lana de cordero, con mosquetón para asegurar al animal, con prácticos bolsillos exteriores, con elementos reflectantes, con correa acolchada regulable para el hombro, carga máx.: 7 kg | Nylon, grande apertura d'ingresso (frontale), con inserto in similpelle d'agnello rimovibile e lavabile, con moschettone per fissare l'animale, con pratiche tasche esterne, con elementi riflettenti, con bretelle imbottite e regolabili, carico massimo 7 kg | Nylon, stor indstigningsåbning (foran), med indlæg af imiteret lammeskind der kan tages ud og vaskes, med karabinhage til sikring af dyret, med praktiske yderlommer, med reflekterende elementer, med polstrede og indstillede skulderremme, kan bære op til 7 kg
schwarz | black | noir | negro | nero | sort

67682 



 40 x 25 x 25 cm
  max. 8,0 kg

Tragetasche PORTLAND



Carrier | Sac de transport | Bolsa | Shopper | Bæretaske

Polyester/Baumwolle, robustes Material, abwaschbar, Einstieg an der Oberseite, mit Schultergurt, eleganter Transport von Haustieren in klassisch-zeitlosen Farben, bis max. 8,0 kg belastbar | Polyester/Cotton, tough material, washable, access from the top, with shoulder strap, elegant transportation of pets in classic, timeless colours, up to a weight of 8.0 kg | Polyester/Coton, en matière robuste, lavable, entrée sur le côté supérieur, avec bandoulière, pour transporter élégamment les animaux familiers dans des teintes classiques et intemporelles, allant jusqu'à 8,0 kg | Poliéster/Algodón, fabricado con material resistente, lavable, entrada por la parte superior, con correa para el hombro, elegante transporte para mascotas en colores que nunca pasan de moda, hasta 8,0 kg de peso | Poliestere/Cotone, materiale robusto, lavabile, accesso sulla parte superiore, con tracolla, trasporto per animali elegante in colori classici e senza tempo, peso massimo di 8,0 kg | Polyester/Bomuld, robust materiale, kan vaskes indvendigt, indstigning ved oversiden, med skulderbælte, elegant transport af husdyr i klassisk-tidløse farver, vægt på op til 8,0 kg

61815 



Mit herausnehmbarer Liegematte aus Lammfellimitat
Removable imitation lambswool inlay

 50 x 30 x 30 cm
  max. 6,5 kg

Tragetasche KANSAS

Carry bag | Sac de transport | Bolsa | Shopper | Bæretaske

Polyester, abwaschbar, platzsparend zusammenfaltbar, mit zwei großen Einstiegsöffnungen, praktische große Außentasche mit Reißverschluss für Clicker, Snacks o.ä., mit herausnehmbarer und waschbarer Einlage aus Lammfell-Imitat, mit zwei praktischen Tragegriffen und breitem, verstellbarem Schulter-Tragegurt (abnehmbar), bis max. 6,5 kg belastbar | Polyester, washable, can be folded to save space, with two large entry openings, large, practical outside pocket with zip for a clicker, snacks etc., with removable and washable insert made of imitation lambskin, with two practical carrying handles and a wide, adjustable shoulder strap (detachable), up to a weight of 6,5 kg | Polyester, lavable, pliable pour gagner de la place, avec deux larges ouvertures d'accès, grand sac extérieur pratique avec fermeture à glissière pour clicker, friandises, etc., avec doublure extractible et lavable en imitation de laine d'agneau, avec deux poignées de transport pratiques et large sangle porteuse d'épaule ajustable (amovible), allant jusqu'à 6,5 kg | Poliéster, lavable, plegable, con dos grandes orificios de entrada, gran bolsa exterior práctica para guardar clickers, golosinas, etc., acolchado extraíble y lavable de imitación de piel de cordero, con dos prácticas asas y una correa ajustable (desmontable), hasta 6,5 kg de peso | Poliester, lavabile, ripiegabile nella formula salvaspazio, con due aperture notevoli e tasche grandi, pratiche con chiusura a zip per i clicker, gli snack, ecc., dotata di inserti lavabili ed estraibili in ecopelle di pecora, con due pratici manici ed un'ampia cintura da spalla regolabile (che si può sfilare), peso massimo di 6,5 kg | Polyester, vaskbar, pladsbesparende, sammenfoldbar med to store indstigningsåbninger, praktisk stor taske til udvendig brug med lynlås til clicker, snacks o.l., med udtageligt og vaskbart indlæg i lammeskinds-imitat, med to praktiske bæregreb og bred indstillelig skulder-bæresele (aftagelig), vægt på op til 6,5 kg

beige/rot | tan/red | beige/rouge | beige/rojo | beige/rosso | beige/rød

62580 

2-IN-1





2in1 Tragetasche & Hundedecke MADISON

Carry bag & Dog blanket | Sac de transport & Couverture pour chiens | Bolsa & Manta de perro | Shopper & Coperta per cani | Bæretaske & Hundeteppe

Polyester/Baumwolle, mit Karabiner zur Sicherung des Tieres, kann auseinander gefaltet als Reisedecke verwendet werden, mit Korbeutel-Etui, mit praktischen Außentaschen, mit zwei Tragegriffen sowie stufenlos verstell- und abnehmbarem Schulterriemen, bis max. 7 kg belastbar | Polyester/Cotton, carabiner to secure the animal, can be folded out and used as a travel blanket, with dog waste bag carrier, with practical exterior pockets, with two carrying handles and individually adjustable, removable shoulder strap, max. load of 7 kg | Polyester/Coton, avec mousqueton pour la sécurité de l'animal, peut servir de couverture de voyage une fois déplié, avec étui pour sacs à excréments, poches extérieures pratiques, deux poignées de transport et une bandoulière amovible et réglable en continu, capacité de charge jusqu'à 7 kg max. | Poliéster/Algodón, con mosquetón para asegurar al animal, puede desplegarse y utilizarse como manta de viaje, con estuche para bolsas de excrementos, con prácticos bolsillos exteriores, con dos asas y correa para el hombro desmontable y regulable de forma continua, carga máx.: 7 kg | Poliestere/Cotone, con moschettone per fissare l'animale, può essere utilizzato come coperta da viaggio quando è aperto, con custodia per le deiezioni, con pratiche tasche esterne, con due maniglie di trasporto e tracolla regolabile in continuo e rimovibile, carico massimo 7 kg | Polyester/Bomuld, med karabinhage til sikring af dyret, kan anvendes som rejseteppe, når foldet fra hinanden, med hundeposeetui, med praktiske yderlommer, med to bærehanke samt trinløst indstillelige og aftagelige skulderremme, kan bære op til 7 kg

khaki | kaki | kaki | caqui | cachi | kaki

67680 

 40 x 25 x 25 cm | 92 x 75 cm  max. 7,0 kg





Tragetasche MADISON

Carry bag | Sac de transport | Bolsa | Shopper | Bæretaske

Polyester/Baumwolle, große Einstiegsöffnung (oben), mit herausnehmbarer und abwaschbarer Einlage aus Lammfell-Imitat, mit Karabiner zur Sicherung des Tieres, mit Kotbeutel-Etui, mit praktischen Außentaschen, mit zwei Tragegriffen sowie stufenlos verstell- und abnehmbarem Schulterriemen, bis max. 7 kg belastbar | Polyester/Cotton, large access opening (top), removable, washable imitation lambskin inlay, with carabiner to secure the animal, with dog waste bag carrier, with practical exterior pockets, with two carrying handles and individually adjustable, removable shoulder strap, max. load of 7 kg | Polyester/Coton, grande ouverture d'accès (en haut), avec fond amovible et lavable en fourrure d'agneau synthétique, mousqueton pour la sécurité de l'animal, étui pour sacs à excréments, poches extérieures pratiques, deux poignées de transport et une bandoulière amovible et réglable en continu, capacité de charge jusqu'à 7 kg max. | Poliéster/Algodón, amplia abertura de entrada (superior), con base extraíble y lavable de imitación de lana de cordero, con mosquetón para asegurar al animal, con estuche para bolsas de excrementos, con prácticos bolsillos exteriores, con dos asas y correa para el hombro desmontable y regulable de forma continua, carga máx.: 7 kg | Poliestere/Cotone, grande apertura d'ingresso (in alto), con inserto in similpelle di agnello rimovibile e lavabile, con moschettone per il fissaggio dell'animale, con sacchetto per deiezioni, con pratiche tasche esterne, con due maniglie di trasporto e tracolla regolabile in continuo e rimovibile, carico massimo 7 kg | Polyester/Bomuld, Stor indstigningsåbning (foroven), med indlæg af imiteret lammeskind der kan tages ud og vaskes, med karabinhage til sikring af dyret, med hundeposeetui, med praktiske yderlommer, med to bærehanke samt trinløst indstillelige og aftagelige skulderremme, kan bære op til 7 kg

khaki | kaki | kaki | caqui | cachi | kaki

67679 

■ 40 x 20 x 30 cm 7,0 kg







Tragetasche BARCELONA

Carry bag | Sac de transport | Bolsa | Shopper | Bæretaske

Polyester/Baumwolle, mit Korbeutel-Etui, Einstieg von oben/seitlich, mit Nylongurt und kleinem Karabiner zur Sicherung des Tieres, bis max. 8,0 kg belastbar | Polyester/Cotton, with dog waste bag pouch, access possible from above/side, with nylon strap and small karabiner to secure the animal, up to a weight of 8.0 kg | Polyester/Coton, avec étui pour sacs sanitaires, entrée possible sur le à l'arrière/sur le côté, avec sangle en nylon et petit mousqueton pour attacher l'animal, allant jusqu'à 8,0 kg | Poliéster/Algodón, con estuche de bolsitas para recogida de excrementos, posibilidad de entrada superior/lateral, con cinturón de nylon y un pequeño mosquetón para la seguridad del animal, hasta 8,0 kg de peso | Poliestere/Cotone, con astuccio porta sacchetti raccogli escrementi, accesso da sopra/di lato, con cinghia in nylon e piccolo moschettone per la sicurezza del vostro animale, peso massimo di 8,0 kg | Polyester/Bomuld, med lorteposeetui, indgang oppeli siden, med nylonrem og lille karabiner til sikring af dyret, vægt på op til 8,0 kg

64569 

 40 x 20 x 30 cm  max. 8,0 kg





■ 60 x 30 cm ↑ max. 8,0 kg

Tragebeutel LOS ANGELES

Carry bag | Sac de transport | Bolso de transporte | Borse trasportino | Bæretaske

Polyester/Baumwolle, Karabiner zur Sicherung des Tieres, bei 30°C waschbar, bis max. 8,0 kg belastbar | *Cotton/Polyester, karabiner to secure the animal, washable at 30°C, up to a weight of 8.0 kg* | *Coton/Polyester, mousqueton pour attacher l'animal, lavable à 30°C, allant jusqu'à 8,0 kg* | *Algodón/Poliéster, mosquetón para la seguridad del animal, lavable a 30°C, hasta 8,0 kg de peso* | *Cotone/Poliestere, moschettone per la sicurezza del vostro animale, lavabile a 30°C, peso massimo di 8,0 kg* | *Bomuld/Polyester, karabiner til sikring af dyret, vaskbar ved 30°C, vægt på op til 8,0 kg*

taupe/grau | taupe/grey | taupe/gris | gris pardo/gris | taupe/grigio | taupe/grå

64573 





Spielzeug

— Toys —

Es darf gespielt werden: HUNTER bietet eine breite Palette an Hundespielzeug, das dem Vierbeiner intelligenten und interaktiven Spielspaß garantiert. Schon angesichts der großen Materialauswahl dürfte jeder Hund sein Lieblingsspielzeug finden. Dabei erfüllen die HUNTER-Spielzeuge auch besondere Ansprüche: Sie sind zum Teil zahnreinigend und zahnpflegend, sind schwimmfähig oder – als Belohnungsspielzeug – sogar mit kleinen Snacks für den Vierbeiner befüllbar.

It is time to play: HUNTER offers a wide range of toys for dogs to guarantee your pet intelligent, interactive fun. With such a wide selection of materials every dog is sure to find its very own favourite toy. And the HUNTER toys meet special demands: They also clean and care for the dog's teeth or they float or – as reward toys – they can even be filled with little snacks for your pet.

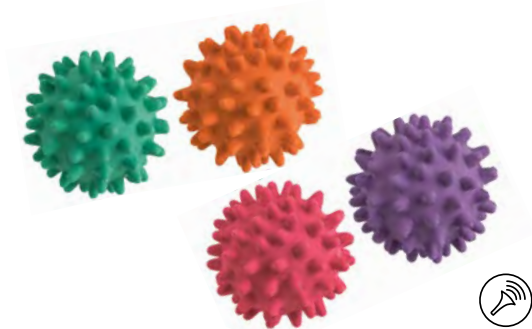

92334 IIII 24/Display

Display Hundespielzeug IGELBALL

Display Dog toy | Support Jouet pour chiens | Soporte Juguete para perros | Espositore Giocattolo per cani | Display Hundelegetøj

Latex, mit Squeaker, nur im Display erhältlich | Latex, with squeaker, only available as display | Latex, avec couineur, uniquement disponible en unité de conditionnement | Látex, con sonido, solo disponible en mostrador | Lattice, con squeaker, disponibile solo in espositore | Latex, med squeaker, fäs kun i display

Igelball

5 cm 92334 



besonders
ROBUST
particularly durable



IIII
3 Stck. | pcs.

Hundespielzeug TOUGH POMBAS

Dog toy | Jouet pour chiens | Juguete para perros | Giocattolo per cani | Hundelegetøj

PVC/Polyester, Füllung: Polyester, mit Squeaker, schwimmfähig, bei 30°C waschbar | PVC/Polyester, filling: Polyester, with squeaker, floating, washable at 30°C | PVC/Polyester, rembourrage: polyester, avec couineur, nageant, lavable à 30°C | PVC/Poliéster, relleno: poliéster, con sonido, flotante, lavable a 30°C | PVC/Polyester, interno: Poliestere, con squeaker, galleggiante, lavabile a 30°C | PVC/Polyester, fyld: Polyester, med squeaker, svømmende, vaskbar ved 30°C

1: Pfeil | Arrow | Flèche | Flecha | Freccia | Pil

35 cm 67762 

2: Frosch | Frog | Grenouille | Rana | Rana | Frø

33 cm 67765 

3: Seelöwe | Sea lion | Lion de mer | León marino | Leone marino | Soløve

35 cm 67764 

4: Knochen | Bone | Os | Hueso | Osso | Knogle

34 cm 67767 



besonders
ROBUST
particularly durable



III
3 Stck. | pcs.

Trainer Snack Dummy TOUGH POMBAS

PVC/Polyester, mit Reißverschluss, befüllbar mit Snacks, bei 30°C waschbar | *PVC/Polyester, with zipper, can be filled with snacks, washable at 30°C* | PVC/Polyester, avec une fermeture à glissière, à remplir de friandises, lavable à 30°C | *PVC/Poliéster, con cremallera, se puede rellenar con comida, lavable a 30°C* | PVC/Polyester, con chiusura lampo, si può riempire con snack, lavabile a 30°C | *PVC/Polyester, med lynlås, kan fylles med godbidder, vaskbar ved 30°C*

orange/beige | orange/tan | orange/beige | naranja/beige | arancione/beige | orange/beige

20 cm 67866



34 cm
Gesamtlänge
total length



III
3 Stck. | pcs.

Trainer Snack Dummy mit Seil

Trainer Snack Dummy with rope | *Trainer Snack Dummy avec corde* | *Trainer Snack Dummy con cuerda* | *Trainer Snack Dummy con corda* | *Trainer Snack Dummy med reb*

Polyester/Nylon, mit Reißverschluss, befüllbar mit Snacks, mit Tau | *Polyester/Nylon, with zipper, can be filled with snacks, with rope* | Polyester/Nylon, avec une fermeture à glissière, à remplir de friandises, avec corde | *Poliéster/Nylon, con cremallera, se puede rellenar con comida, con cuerda* | Polyester/Nylon, con chiusura lampo, si può riempire con snack, con corda | *Polyester/Nylon, med lynlås, kan fylles med godbidder, med tov*

orange/schwarz | orange/black | orange/noir | naranja/negro | arancione/nero | orange/sort

20 cm 67865



III
3 Stck. | pcs.

Trainer Snack Dummy

Polyester, mit Reißverschluss, befüllbar mit Snacks, bei 30°C waschbar | *Polyester, with zipper, can be filled with snacks, washable at 30°C* | Polyester, avec une fermeture à glissière, à remplir de friandises, lavable à 30°C | *Poliéster, con cremallera, se puede rellenar con comida, lavable a 30°C* | Polyester, con chiusura lampo, si può riempire con snack, lavabile a 30°C | *Polyester, med lynlås, kan fylles med godbidder, vaskbar ved 30°C*

1: orange | orange | orange | naranja | arancione | orange

15 cm 42579

2: beige | tan | beige | beige | beige | beige

20 cm 42098

3: grau | grey | gris | gris | grigio | grå

25 cm 42580

4: dunkelgrau | dark grey | gris foncé | gris oscuro | grigio scuro | mørkegrå

30 cm 42581



Trainer Snack Dummy mit Seil

Trainer Snack Dummy with rope | Trainer Snack Dummy avec corde | Trainer Snack Dummy con cuerda | Trainer Snack Dummy con corda | Trainer Snack Dummy med reb

Polyester, mit Reißverschluss, befüllbar mit Snacks, mit Tau | *Polyester, with zipper, can be filled with snacks, with rope* | Polyester, avec une fermeture à glissière, à remplir de friandises, avec corde | *Poliéster, con cremallera, se puede rellenar con comida, con cuerda* | Polyester, con chiusura lampo, si può riempire con snack, con corda | *Polyester, med lynlås, kan fyldes med godbidder, med tov*

altrosa | old pink | vieux rose | rosa viejo | rosa antico | gammel pink

20 cm 201779 

taupe

20 cm 201770 

schwarz | black | noir | negro | nero | sort

20 cm 201761 



III
3 Stck. | pcs.

34 cm
Gesamtlänge
total length



49 cm
Gesamtlänge
total length

besonders
ROBUST
particularly durable

III
3 Stck. | pcs.

Dummy TRIENT

Trainingsdummy aus extrem strapazierfähigem, widerstandsfähigem Nylon, ideal für Training und Spiel, mit Handschlaufe | *Training dummy made from extremely hard-wearing, robust nylon, ideal for training and games, with wrist strap* | Dummy d'entraînement en nylon extrêmement solide et résistant, idéal pour les séances d'entraînement et de jeu, avec dragonne | *Dummy de entrenamiento hecho de nylon robusto y resistente, ideal para entrenamientos y juegos, con correa de mano* | Dummy da addestramento in nylon estremamente robusto e resistente, ideale per l'addestramento e il gioco, con cinturino da polso | *Trænings-dummy i ekstra slidstærkt, modstandsdygtigt nylon, perfekt til træning og leg, med håndrem*

rot | red | rouge | rojo | rosso | rød

30 cm 65896 



20 cm / 30 cm
Gesamtlänge
total length



III
3 Stck. | pcs.



Hundenspielzeug INARI

Dog toy | Jouet pour chiens | Juguete para perros | Giocattolo per cani | Hundelegetoj

Baumwolle, kann bei der Zahnreinigung unterstützen | *Cotton, can help to clean teeth* | Coton, peut aider à nettoyer les dents | *Algodón, complementa la limpieza dental* | Cotone, può aiutare nella pulizia bucale | *Bomuld, kan understøtte tandrensning*

beige | tan | beige | beige | beige | beige

6 cm 69562  10 cm 69565 

pastellrot | pastel red | rouge pastel | rojo pastel | rosso pastello | pastelrod

6 cm 69560  10 cm 69563 

lindgrün | linden green | vert pâle | verde suave | verdino chiaro | lindengrøn

6 cm 69561  10 cm 69564 



Kompakter Ball mit Handschleufe

Der Ball mit Handschleufe im modernen INARI-Farbkonzept aus 100% Baumwolle ist ein klassisches Tau-Apportier-Spielzeug und für kleine, mittlere und große Hunde geeignet. Zudem bietet er eine spielerische Zahnfleischmassage und kann somit die Zahnreinigung unterstützen.

Compact ball with hand loop

The ball with hand loop in the modern Inari colour concept made of 100% cotton is a classic rope retrieving toy and suitable for small, medium and large dogs. It also offers a playful gum massage and can thus support teeth cleaning.

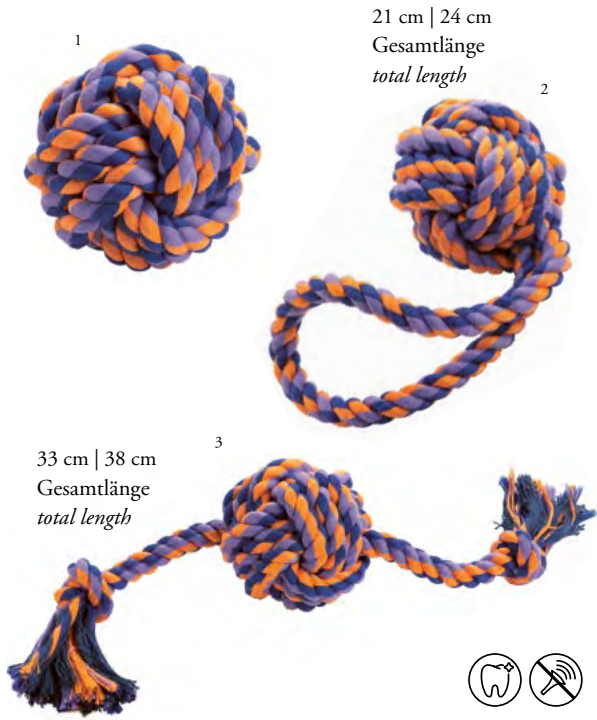

21 cm | 24 cm
Gesamtlänge
total length

33 cm | 38 cm
Gesamtlänge
total length



III
3 Stck. | pcs.



40 cm
Gesamtlänge
total length



III
3 Stck. | pcs.

Hundespielzeug JENA

Dog toy | Jouet pour chiens | Juguete para perros | Giocattolo per cani | Hundelegetøj

Baumwolle/Polyester, kann bei der Zahnreinigung unterstützen | *Cotton/Polyester, can help to clean teeth* | Coton/Polyester, peut aider à nettoyer les dents | *Algodón/Poliéster, complementa la limpieza dental* | Cotone/Poliestere, può aiutare nella pulizia bucale | *Bomuld/Polyester, kan understøtte tandrensning*

1: Ball | Ball | Balle | Balón | Palla | Bold

6,5 cm 67721

2: Ball mit Handschlaufe | Ball with hand loop | Balle avec dragonne | Pelota con correa para la mano | Palla con cinturino da polso | Bold med håndrem

6 cm 67723 7,5 cm 67724

3: Ball mit Tau | Ball with rope | Balle avec corde | Pelota con cuerda | Palla con corda | Bold med reb

6,5 cm 67719 7 cm 67720

Hundespielzeug JAMUNA

Dog toy | Jouet pour chiens | Juguete para perros | Giocattolo per cani | Hundelegetøj

Vollgummi, mit Tau | *Rubber, with rope* | Caoutchouc, avec corde | *De goma, con cuerda* | Gomma piena, con corda | *Massivt gummi, med tov*

6 cm 67725



assorted colours

III

3 Stck. | pcs.

Hundenspielzeug SPIKE BALL

Dog toy | Jouet pour chiens | Juguete para perros | Giocattolo per cani | Hundelegetoj

Vollgummi, mit Tau, kann bei der Zahnreinigung unterstützen, farblich sortiert (2x Schwarz, 1x Gelb) | *Rubber, with rope, can help to clean teeth, assorted colours (2x Black, 1x Yellow)* | Caoutchouc, avec corde, peut aider à nettoyer les dents, couleurs assorties (2x Noir, 1x Jaune) | *De goma, con cuerda, complementa la limpieza dental, disponible en distintos colores (2x Negro, 1x Amarillo)* | Gomma piena, con corda, può aiutare nella pulizia bucale, suddiviso (2x Nero, 1x Giallo) | *Massiivt gummi, med tov, kan understøtte tandrensning, färvemässigt sorteret (2x Sort, 1x Gul)*

30 cm 92341 

33 cm
Gesamtlänge
total length



assorted colours

III

3 Stck. | pcs.

Hundenspielzeug KNOTEN

Dog toy | Jouet pour chiens | Juguete para perros | Giocattolo per cani | Hundelegetoj

Vollgummi, mit Tau, farblich sortiert (2x Schwarz, 1x Gelb) | *Rubber, with rope, assorted colours (2x Black, 1x Yellow)* | Caoutchouc, avec corde, couleurs assorties (2x Noir, 1x Jaune) | *De goma, con cuerda, disponible en distintos colores (2x Negro, 1x Amarillo)* | Gomma piena, con corda, disponibile en distintos colores (2x Nero, 1x Giallo) | *Massiivt gummi, med tov, färvemässigt sorteret (2x Sort, 1x Gul)*

16 cm 92343 





KISA Ball mit Squeaker
with Squeaker



III
3 Stck. | pcs.

Hundenspielzeug AQUA KISA

Dog toy | Jouet pour chiens | Juguete para perros | Giocattolo per cani | Hundelegetøj

TPR (fluoreszierend), schwimmfähig, kann bei der Zahnreinigung unterstützen, leuchtet im Dunkeln | *TPR (fluorescent), floating, can help clean teeth, glows in the dark* | TPR (fluorescent), nageant, peut aider à nettoyer les dents, brille dans l'obscurité | *TPR (fluorescente), flotante, puede ayudar a limpiar los dientes, brilla en la oscuridad* | TPR (fluorescente), galleggiante, può aiutare a pulire i denti, brilla al buio | *TPR (fluorescerende), svømmende, kan understøtte rengøring af tænder, lyser i mørke*

Ball | Ball | Balle | Balón | Palla | Bold

7 cm 68994

Knochen | Bone | Os | Hueso | Osso | Knogle

11 cm 68995



XL
52 cm



III
3 Stck. | pcs.

Hundenspielzeug AQUA MINDELO

Dog toy | Jouet pour chiens | Juguete para perros | Giocattolo per cani | Hundelegetøj

Nylon, Füllung: EVA, mit Squeaker, schwimmfähig, bei 30°C waschbar | *Nylon, filling: EVA, with squeaker, floating, washable at 30°C* | Nylon, rembourrage : EVA, avec couineur, nageant, lavable à 30°C | *Nailon, relleno: EVA, con sonido, flotante, lavable a 30°C* | Nylon, imbottitura: EVA, con squeaker, galleggiante, lavabile a 30°C | *Nylon, fyld: EVA, med squeaker, svømmende, vaskbar ved 30°C*

orange | orange | orange | naranja | arancione | orange

52 cm 67729

blau | blue | bleu | azul | blu | blå

52 cm 67731

grün | green | vert | verde | verde | grøn

52 cm 67730



besonders
ROBUST
particularly durable



||||
3 Stck. | pcs.



**SCRATCH
IT AWAY!**

BEFORE AFTER

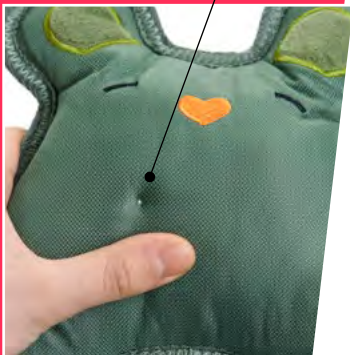

Hundenspielzeug TOUGH TUNDRA

Dog toy | Jouet pour chiens | Juguete para perros | Giocattolo per cani | Hundelegetoj

Polypropylen/Polyester, dichter, strukturierter Stoff, äußerst robust, hohe Zugfestigkeit, beständig gegen Abrieb und Verschleiß, doppelt verstärkte Nähte, mit Griffloch | Polypropylene/polyester, dense, structured fabric, extremely robust, high tensile strength, resistant to abrasion and wear, double reinforced seams, with grip hole | Polypropylène/polyester, tissu dense et structuré, extrêmement robuste, haute résistance à la traction, résistant à l'abrasion et à l'usure, coutures doublement renforcées, avec trou de préhension | Polipropileno/poliéster, tejido denso y estructurado, extremadamente robusto, alta resistencia a la tracción, resistente a la abrasión y al desgaste, costuras doblemente reforzadas, con orificio de agarre | Polipropilene/poliestere, tessuto denso e strutturato, estremamente robusto, ad alta resistenza alla trazione, resistente all'abrasione e all'usura, cuciture rinforzate a doppia mandata, con foro di presa | Polypropylen/polyester, tæt, strukturert stof, ekstremt robust, høj trækstyrke, modstandsdygtig over for slid og slitage, dobbeltforstærkede sømme, med hul til greb

1: Eule | Owlet | Hibou | Lechuza | Civetta | Ugle

26 cm 204922

2: Maus | Mouse | Souris | Ratón | Topo | Mus

25 cm 204925

3: Fuchs | Fox | Renard | Zorro | Volpe | Fox

29 cm 204919

4: Waschbär | Raccoon | Raton laveur | Mapache | Procione | Vaskebjørn

25 cm 204916

Robustes Material für langanhaltenden Spaß!

Bei diesem extrem widerstandsfähigen Zergel-Spielzeug mit sehr hoher Zugfestigkeit lassen sich durch die besondere Beschaffenheit des robusten Strukturstoffs mögliche Bissspuren einfach aus dem Material »kratzen«. Das Material ist zudem äußerst beständig gegen Abrieb und Verschleiß.

Robust material for long-lasting fun!

With this extremely resistant tug toy with very high tensile strength, any bite marks can simply be "scratched" out of the material thanks to the special nature of the robust textured fabric. The material is also extremely resistant to abrasion and wear.



III
3 Stck. | pcs.

Hundenspielzeug TOUGH TOYS

Dog toy | Jouet pour chiens | Juguete para perros | Giocattolo per cani | Hundelegetøj

Polyester, mit Squeaker | *Polyester, with squeaker* | Polyester, avec couineur | *Poliéster, con sonido* | Poliestere, con squeaker | *Polyester, med squeaker*

1: Affe | Monkey | Singe | Mono | Scimmia | Abe

25 cm 66549 

2: Nashorn | Rhino | Rhinocéros | Rinoceronte | Rinoceronte | Næsehorn

24 cm 66548 

3: Alligator | Alligator | Alligator | Caimán | Alligatore | Alligator

27 cm 66550 



besonders
ROBUST
particularly durable

III
3 Stck. | pcs.

Hundenspielzeug TOUGH KAMERUN

Dog toy | Jouet pour chiens | Juguete para perros | Giocattolo per cani | Hundelegetøj

Polyester | *Polyester* | Polyester | *Poliéster* | Poliestere | *Polyester*

1: Elch | Elk | Élan | Alce | Alce | Elg

29 cm 65720 

2: Gorilla | Gorilla | Gorille | Gorila | Gorilla | Gorilla

29 cm 65722 

3: Bär | Bear | Ours | Oso | Orso | Bjørn

29 cm 65723 

4: Mammut | Mammoth | Mammoth | Mamut | Mammut | Mammut

29 cm 65721 



Recycling-Hundenspielzeug

Recycling-Dog toys

Modern, nachhaltig, fair. HUNTER ist sich der Verantwortung bewusst, nach besseren Lösungen und neuen, umweltschonenden Wegen zu suchen. Konsequenterweise vergrößert sich auch stetig die Kollektion von Hundenspielzeugen, die aus up- und recycelten Materialien bestehen. Was kann man sich Schöneres vorstellen, als dass ein aussortierter Pullover in seinem zweiten Leben als Lieblingsspielzeug in Form eines niedlichen Stofftieres den vierbeinigen besten Freund glücklich macht? Und wenn dieses Spielzeug auch noch so frech und witzig aussieht, wie diese lustigen Charaktere, fällt es schwer sich für eines zu entscheiden.

Modern, sustainable, fair. HUNTER is aware of its responsibility to look for better solutions and new, environmentally friendly ways. Consequently, the collection of dog toys made from upcycled and recycled materials is constantly growing. What could be nicer than a discarded jumper in its second life as a favourite toy in the form of a cute stuffed animal to make your four-legged best friend happy? And when these toys look as cheeky and funny as these amusing characters, it's hard to decide which one to choose.



III
3 Stck. | pcs.

Up/Re-Cycling-Hundespielzeug FLORENZ

Dog toy | Jouet pour chiens | Jugete para perros | Giocattolo per cani | Hundelegetøj

Wolle/Polyester (upcycled), Füllung: Polyfiber (recycled), bei 30°C waschbar | Wool/Polyester (upcycled), filling: polyfibre (recycled), washable at 30°C | Laine/Polyester (recyclé), rembourrage: polyfibre (recyclé), lavable à 30°C | Lana/Poliéster (reciclaje creativo), relleno: polifibra (reciclada), lavable a 30°C | Lana/Poliestere (upcycled), Imbottitura: polifibra (riciclata), lavabile a 30°C | Uld/Polyester (genopbejdet), Fyld: Polyfiber (genopbejdet), vaskbar ved 30°C

1. Biene | Bee | Abeille | Abeja | Ape | Bi

29 cm 69305

2. Hummel | Bumblebee | Bourdon | Abejorro | Bumblebee | Hummel

22 cm 69306

3. Raupe | Caterpillar | Chenille | Oruga | Caterpillar | Caterpillar

22 cm 69307

4. Marienkäfer | Ladybird | Coccinelle | Mariquita | Coccinella | Mariehøne

20 cm 69308





Up/Re-Cycling-Hundespielzeug BILLUND

Dog toy | Jouet pour chiens | Juguete para perros | Giocattolo per cani | Hundelegetoj

Wolle/Polyester (upcycled), 69352 & 69355: Füllung: Polyfiber (recycled), bei 30 °C waschbar | Wool/Polyester (upcycled), 69352 & 69355: Filling: polyfibre (recycled), washable at 30 °C | Laine/Polyester (recyclé), 69352 & 69355: Rembourrage: polyfibre (recyclé), lavable à 30 °C | Lana/Poliéster (reciclaje creativo), 69352 & 69355: Relleno: polifibra (reciclada), lavable a 30 °C | Lana/Poliestere (upcycled), 69352 & 69355: Imbottitura: polifibra (riciclata), lavabile a 30 °C | Uld/Polyester (genoparbejdet), 69352 & 69355: Fyld: Polyfiber (genoparbejdet), vaskbar ved 30 °C



1: Bär | Bear | Ours | Oso | Orso | Bjørn

23 cm 69352

2: Fuchs | Fox | Renard | Zorro | Volpe | Fox

23 cm 69355

3: Bär flach | Bear flat | Ours plat | Oso plano | Orso piatto | Bjørn flad

40 cm 69353

4: Fuchs flach | Fox flat | Renard plat | Zorro plano | Volpe piatto | Fox flad

40 cm 69356

5: Bär Schnüffelteppich | Bear Playmat | Ours Tapis de reniflage | Oso Alfombra para oler | Orso Tappetino da fiuto | Bjørn Sniffing tæppe

75 cm 69354



III
3 Stck. | pcs.

Befüllbar mit Snacks
Can be filled with snacks





III
3 Stck. | pcs.

Up/Re-Cycling-Hundespielzeug EIBY

Dog toy | Jouet pour chiens | Juguete para perros | Giocattolo per cani | Hundelegetøj

Wolle/Polyester (upcycled), Füllung: Polyfiber (recycled), bei 30°C waschbar | *Wool/Polyester (upcycled), filling: Polyfibre (recycled), washable at 30°C* | Laine/Polyester (recyclé), rembourrage : Polyfibre (recyclé), lavable à 30°C | *Lana/Poliéster (reciclaje creativo), relleno: Polifibra (reciclada), lavable a 30°C* | Lana/Poliestere (upcycled), Imbottitura: Polifibra (riciclata), lavabile a 30°C | *Uld/Polyester (genoparbejdet), Fyld: Polyfiber (genoparbejdet), vaskbar ved 30°C*

1: Giraffe | Giraffe | Girafe | Jirafa | Giraffa | Giraffe

18 cm 68639 21 cm 68640

2: Elefant | Elephant | Éléphant | Elefante | Elefante | Elefant

19 cm 68641 22 cm 68642

3: Wal | Whale | Baleine | Ballena | Balena | Hval

18 cm 68643 24 cm 68644



Befüllbar mit Snacks
Can be filled with snacks

III
3 Stck. | pcs.

Up/Re-Cycling-Hundespielzeug Schnüffelball EIBY

Dog toy Sniffle ball | Jouet pour chiens Balle à renifler | Juguete para perros Bola para olfatear | Giocattolo per cani Palla di fiuto | Hundelegetøj Sniffing Ball

Wolle/Polyester (upcycled), befüllbar mit Snacks, bei 30°C waschbar | *Wool/Polyester (upcycled), can be filled with snacks, washable at 30°C* | Laine/Polyester (recyclé), à remplir de friandises, lavable à 30°C | *Lana/Poliéster (reciclaje creativo), se puede rellenar con comida, lavable a 30°C* | Lana/Poliestere (upcycled), i può riempire con snack, lavabile a 30°C | *Uld/Polyester (genoparbejdet), kan fyldes med godbidder, vaskbar ved 30°C*

Schnüffelball | Sniffle ball | Balle à renifler | Pelota de olfato | Palla di fiuto | Sniffle bold

15 cm 69357



Up/Re-Cycling-Hundespielzeug FYN

Dog toy | Jouet pour chiens | Juguete para perros | Giocattolo per cani | Hundelegetoj

Wolle/Polyester (upcycled), Füllung: Polyfiber (recycled), mit Squeaker aus Naturkautschuk, bei 30 °C waschbar | *Wool/Polyester (upcycled), filling: polyfibre (recycled), with natural rubber squeaker, washable at 30 °C* | Laine/Polyester (recyclé), rembourrage: polyfibre (recyclé), avec couineur en caoutchouc naturel, lavable à 30 °C | *Lana/Poliéster (reciclaje creativo), relleno: polifibra (reciclada), con sonido de caucho natural, lavable a 30 °C* | Lana/Poliestere (upcycled), imbottitura: polifibra (riciclata), con squeaker in gomma naturale, lavabile a 30 °C | *Uld/ Polyester (genoparbejdet), fyld: polyfiber (genoparbejdet), med squeaker af naturgumm, vaskbar ved 30 °C*

1: Bär | Bear | Ours | Oso | Orso | Björn

20 cm 69729

2: Igel | Hedgehog | Hérisson | Erizo | Riccio | Pindsvin

20 cm 69728

3: Hamster | Hamster | Hamster | Hámster | Criceto | Hamster

20 cm 69725

4: Murmeltier | Marmot | Marmotte | Marmot | Marmotta | Marmot

20 cm 69726

5: Dachs | Badger | Blaireau | Tejón | Tasso | Grävling

20 cm 69727

III
3 Stck. | pcs.





Up/Re-Cycling-Hundespielzeug MARLE

Dog toy | Jouet pour chiens | Juguete para perros | Giocattolo per cani | Hundelegetøj

Wolle/Polyester (upcycled), Füllung: Polyfiber (recycled), bei 30 °C waschbar | Wool/Polyester (upcycled), filling: polyfibre (recycled), washable at 30 °C | Laine/Polyester (recyclé), rembourrage: polyfibre (recyclé), lavable à 30 °C | Lana/Poliéster (reciclaje creativo), relleno: polifibra (reciclada), lavable a 30 °C | Lana/Poliester (upcycled), imbottitura: polifibra (riciclata), lavabile a 30 °C | Uld/Polyester (genoparbejdet), fyld: polyfiber (genoparbejdet), vaskbar ved 30 °C

1: Hund | Dog | Chien | Perro | Cane | Hund

35 cm 69899

2: Schaf | Sheep | Mouton | Oveja | Pecora | Får

35 cm 69896

3: Hase | Rabbit | Lièvre | Liebre | Lepre | Hare

35 cm 69898

4: Schwein | Pig | Cochon | Cerdo | Porco | Svin

35 cm 69897

XL
35 cm



III
3 Stck. | pcs.







Up/Re-Cycling-Hundespielzeug SKAGEN

Dog toy | Jouet pour chiens | Juguete para perros | Giocattolo per cani | Hundelegetøj

Wolle/Polyester (upcycled), Füllung: Polyfiber (recycled), bei 30°C waschbar | Wool/Polyester (upcycled), filling: Polyfibre (recycled), washable at 30°C | Laine/Polyester (recyclé), rembourrage: Polyfibre (recyclé), lavable à 30°C | Lana/Poliéster (reciclaje creativo), relleno: polifibra (reciclada), lavable a 30°C | Lana/Poliestere (upcycled), Imbottitura: polifibra (riciclata), lavabile a 30°C | Uld/Polyester (genoparbejdet), Fyld: Polyfiber (genoparbejdet), vaskbar ved 30°C

1: Seestern | Starfish | Étoile de mer | Estrella de mar | Stella di mare | Søstjerne

20 cm 69000

2: Steinbutt | Turbot | Turbot | Rodaballo | Turbot | Pighvar

21 cm 69001

3: Tintenfisch | Octopus | Octopus | Pulpo | Polipo | Blæksprutte

20 cm 69002

4: Seerobbe | Sea seal | Phoque de mer | Foca marina | Sigillo di mare | Forsegle

25 cm 69003

III
3 Stck. | pcs.



Up/Re-Cycling-Hundespielzeug TIRANA

Dog toy | Jouet pour chiens | Juguete para perros | Giocattolo per cani | Hundelegetøj

Wolle/Polyester (upcycled), Füllung: Polyfiber (recycled), bei 30°C waschbar | Wool/Polyester (upcycled), filling: Polyfibre (recycled), washable at 30°C | Laine/Polyester (recyclé), rembourrage: Polyfibre (recyclé), lavable à 30°C | Lana/Poliéster (reciclaje creativo), relleno: Polifibra (reciclada), lavable a 30°C | Lana/Poliestere (upcycled), Imbottitura: Polifibra (riciclata), lavabile a 30°C | Uld/Polyester (genoparbejdet), Fyld: Polyfiber (genoparbejdet), vaskbar ved 30°C

1: Lama | Lama | Lama | Llama | Lama | Lama

25 cm 67781

2: Bär | Bear | Ours | Oso | Orso | Bjørn

26 cm 67783

3: Hase | Rabbit | Lièvre | Liebre | Lepre | Hare

8 cm 67785

18 cm
Gesamtlänge
total length

III
3 Stck. | pcs.



Besonders robust durch
innenliegende Nähte
Especially robust due to internal seams



III
3 Stck. | pcs.

Recycling-Hundespielzeug TOUGH MONSTER

Dog toy | Jouet pour chiens | Juguete para perros | Giocattolo per cani | Hundelegetøj

rPET Sherpa (recycled), Füllung: Polyester (recycled), verstärkte innenliegende Nähte, mit Squeaker, bei 30°C waschbar | *rPET Sherpa (recycled), filling: polyester (recycled), reinforced inner seams, with squeaker, washable at 30°C* | rPET Sherpa (recyclé), rembourrage : polyester (recyclé), coutures intérieures renforcées, avec squeaker, lavable à 30°C | *rPET Sherpa (reciclado), relleno: poliéster (reciclado), costuras interiores reforzadas, con chirriador, lavable a 30°C* | rPET Sherpa (riciclato), imbottitura: poliestere (riciclato), cuciture interne rinforzate, con squeaker, lavabile a 30°C | *rPET Sherpa (genanvendt), fyld: polyester (genanvendt), forstærkede indvendige sømme, med pibeklap, vaskbar ved 30°C*

1: Gina

20 cm 69412

2: Karl

24 cm 69413

3: Hermine

20 cm 69414

4: Larry

23 cm 69415



III
3 Stck. | pcs.

Recycling-Hundespielzeug SANSIBAR KAMPEN

Dog toy | Jouet pour chiens | Juguete para perros | Giocattolo per cani | Hundelegetøj

Baumwolle, Füllung und Tau: Polyester (recycled), bei 30°C waschbar | *Cotton, filling and rope: polyester (recycled), washable at 30°C* | Coton, rembourrage et corde : polyester (recyclé), lavable à 30°C | *Algodón, relleno y cuerda: poliéster (reciclado), lavable a 30°C* | Cotone, imbottitura e corda: poliestere (riciclato), lavabile a 30°C | *Bomuld, fyld og reb: polyester (genanvendt), vaskbar ved 30°C*

1: Anker | Anchor | Ancre | Ancla | Ancora | Anker

22 cm 69425

2: Leuchtturm | Lighthouse | Phare | Faro | Faro | Fyrtårn

24 cm 69426

3: Seerobbe | Sea seal | Phoque de mer | Foca marina | Sigillo di mare | Forsegle

16 cm 69427



Recycling-Hundespielzeug NEBRASKA

Dog toy | Jouet pour chiens | Juguete para perros | Giocattolo per cani | Hundelegetøj

Baumwolle (recycled), Füllung und Tau: Polyester (recycled), kann die Zahnreinigung unterstützen, bei 30°C waschbar | *Cotton (recycled), filling and rope: polyester (recycled), can support tooth cleaning, washable at 30°C* | Coton (recyclé), rembourrage et rosée : polyester (recyclé), peut favoriser le nettoyage des dents, lavable à 30°C | *Algodón (reciclado), relleno y cuerda: poliéster (reciclado), admite limpieza dental, lavable a 30°C* | Cotone (riciclato), imbottitura e corda: poliestere (riciclato), in grado di supportare la pulizia dei denti, lavabile a 30°C | *Bomuld (genanvendt), fyld og reb: polyester (genanvendt), kan understøtte tandrensning, vaskbar ved 30°C*

1: Schaf | Sheep | Mouton | Oveja | Pecora | Får

28 cm **69419**

2: Kuh | Cow | Vache | Vacca | Mucca | Ko

25 cm **69417**

3: Pferd | Horse | Cheval | Caballo | Cavallo | Hest

25 cm **69416**

4: Ziege | Goat | Chèvre | Cabra | Capra | Ged

30 cm **69418**



III
3 Stck. | pcs.



Mit robustem
Tau
With robust rope



Recycling-Hundespielzeug RIO

Dog toy | Jouet pour chiens | Juguete para perros | Giocattolo per cani | Hundelegetoj

Polyester (recycled), Tau: Baumwolle, kann die Zahnreinigung unterstützen, bei 30°C waschbar | Polyester (recycled), dew: cotton, can support tooth cleaning, washable at 30°C | Polyester (recyclé), tau : coton, peut favoriser le nettoyage des dents, lavable à 30°C | Poliéster (reciclado), roció: algodón, admite limpieza dental, lavable a 30°C | Poliestere (riciclato), tau: cotone, può supportare la pulizia dei denti, lavabile a 30°C | Polyester (genanvendt), dug: bomuld, kan tåle tandrensning, vaskbar ved 30°C

1: Affe | Monkey | Singe | Mono | Scimmia | Abe

40 cm 69420

2: Koala

30 cm 69421

3: Schlange | Snake | Serpent | Serpiente | Serpente | Slange

60 cm 69422

4: Fledermaus | Bat | Chauve-souris | Murciélago | Pipistrello | Flagermus

25 cm 69423

5: Faultier | Sloth | Sloth | Pereza | Bradipo | Dovendyr

30 cm 69424

III
3 Stck. | pcs.

Mit robustem
Tau
With robust rope





Mit robustem
Tau
With robust rope

XXL

Hundenspielzeug MADRID

Dog toy | Jouet pour chiens | Juguete para perros | Giocattolo per cani | Hundelegetøj

Polyester/Baumwolle, mit Tau, kann die Zahnreinigung unterstützen, bei 30°C waschbar | Polyester/cotton, with rope, can support tooth cleaning, washable at 30°C | Polyester/coton, avec corde, peut favoriser le nettoyage des dents, lavable à 30°C | Poliéster/algodón, con cuerda, admite limpieza dental, lavable a 30°C | Poliestere/cotone, con corda, può supportare la pulizia dei denti, lavabile a 30°C | Polyester/bomuld, med tov, kan tåle tandrensning, kan vaskes ved 30°C

1: braun | brown | marron | marrón | marrone | brun

52 cm 207415

2: grau | grey | gris | gris | grigio | grå

59 cm 207418

3: grün/beige | green/tan | vert/beige | verde/beige | verde/beige | grøn/beige

37 cm 207412

4: grün/braun/grau/rosa | green/brown/grey/pink | vert/marron/gris/rose | verde/marrón/gris/rosa | verde/marrone/grigio/rosa | grøn/brun/grå/lyserød

45 cm 207421



III
3 Stck. | pcs.

43 cm
Gesamtlänge
total length



III
3 Stck. | pcs.

Hundenspielzeug CANVAS SANSIBAR RANTUM

Dog toy | Jouet pour chiens | Juguete para perros | Giocattolo per cani | Hundelegetoj

Baumwolle/Polyester, mit Squeaker, mit Tau, kann bei der Zahnreinigung unterstützen, bei 30°C waschbar | Cotton/Polyester, with squeaker, with rope, can help to clean teeth, washable at 30°C | Coton/Polyester, avec couineur, avec corde, peut aider à nettoyer les dents, lavable à 30°C | Algodón/Poliéster, con sonido, con cuerda, complementa la limpieza dental, lavable a 30°C | Cotone/Poliestere, con squeaker, con corda, può aiutare nella pulizia bucale, lavabile a 30°C | Bomuld/Polyester, med squeaker, med tov, kan understøtte tandrensning, vaskbar ved 30°C

Hummer | Lobster | Homard | Bogavante | Astice | Hummer

21 cm 65661



28 cm
Gesamtlänge
total length

30 cm
Gesamtlänge
total length



III
3 Stck. | pcs.

Hundenspielzeug SALIMA

Dog toy | Jouet pour chiens | Juguete para perros | Giocattolo per cani | Hundelegetoj

Polyester, mit Squeaker, mit Tau | Polyester, with squeaker, with rope | Polyester, avec couineur, avec corde | Poliéster, con sonido, con cuerda | Poliester, con squeaker, con corda | Polyester, med squeaker, med tov

1: Knochen rosa | Bone light pink | Os rose clair | Hueso rosa pálido | Osso rosa | Knogle lyserød

18 cm 67459

2: Knochen grau | Bone grey | Os gris | Hueso gris | Osso grigio | Knogle grå

18 cm 67460

3: Stern rosa | Star light pink | Astre rose clair | Estrella rosa pálido | Stella rosa | Stjerne lyserød

17 cm 67461

4: Stern grau | Star grey | Astre gris | Estrella gris | Stella grigio | Stjerne grå

17 cm 67462





1

50 cm
Gesamtlänge
total length



2



3



4



5



Hundespielzeug CANVAS

Dog toy | Jouet pour chiens | Juguete para perros | Giocattolo per cani | Hundelegetøj

Baumwolle, Füllung (Polyester), mit Squeeaker, mit Raw-Edge Nähten, bei 30°C waschbar | Cotton, Polyester filling, with squeeaker, with raw-edge seams, washable at 30°C | Coton, rembourrage (polyester), avec couineur, avec des coutures raw-edge, lavable à 30°C | Algodón, relleno (poliéster), con sonido, con costuras ribeteadas, lavable a 30°C | Cotonne, l'imbottitura (poliestere), con squeeaker, con cuciture non orlate, lavabile a 30°C | Bomuld, fyld (polyester), med squeeaker, med raw-edge somme, vaskbar ved 30°C

1: Wild Duck

30 cm 60953 

2: Wild Rabbit

27 cm 60840 

3: Wild Goose

38 cm 60839 

4: Maritime Sea gull

30 cm 64668 

5: Ring Ox

27 cm 60954 

III
3 Stck. | pcs.



III
3 Stck. | pcs.

Hundespielzeug BARRY

Dog toy | Jouet pour chiens | Juguete para perros | Giocattolo per cani | Hundelegetoj

Polyester, mit Squeaker, waschbar bei 30 °C | *Polyester, with squeaker, washable at 30 °C* | Polyester, avec couineur, lavable à 30 °C | *Poliéster, con sonido, lavable a 30 °C* | Poliestere, con squeaker, lavabile a 30 °C | *Polyester, med squeaker, vaskbar ved 30 °C*

1: Maus | Mouse | Souris | Ratón | Topo | Mus

20 cm 67646

2: Wolf | Wolf | Loup | Lobo | Lupo | Ulv

19 cm 67647

3: Hund | Dog | Chien | Perro | Cane | Hund

16 cm 67648



III
3 Stck. | pcs.

Hundespielzeug KOLDING

Dog toy | Jouet pour chiens | Juguete para perros | Giocattolo per cani | Hundelegetoj

Polyester, mit Squeaker, bei 30°C waschbar | *Polyester, with squeaker, washable at 30°C* | Polyester, avec couineur, lavable à 30°C | *Poliéster, con sonido, lavable a 30°C* | Poliestere, con squeaker, lavabile a 30°C | *Polyester, med squeaker, vaskbar ved 30°C*

1: Pferd | Horse | Cheval | Caballo | Cavallo | Hest

37 cm 67747

2: Eule | Owllet | Hibou | Lechuza | Civetta | Ugle

26 cm 67748

3: Ente | Duck | Canard | Pato | Anatra | And

36 cm 67749





Hundespielzeug HUGGLY

Dog toy | Jouet pour chiens | Juguete para perros | Giocattolo per cani | Hundelegetøj

Baumwolle, Füllung aus Polyester, besonders weich, bei 30°C waschbar | Cotton, filling made from polyester, very soft, washable at 30°C | Coton, remplissage en polyester, particulièrement doux, lavable à 30°C | Algodón, relleno de poliéster, especialmente blando, lavable a 30°C | Cotone, imbottitura in poliester, particolarmente morbido, lavabile a 30°C | Bomuld, med polyesterfyld, superblødt, vaskbar ved 30°C

1: Blanket Donkey

27 cm 60670

2: Zoo Donkey

25 cm 60673

3: Zoo Giraffe

25 cm 60675

4: Zoo Lion

25 cm 60674

5: Amazonas Hippo

24 cm 60668

III
3 Stck. | pcs.

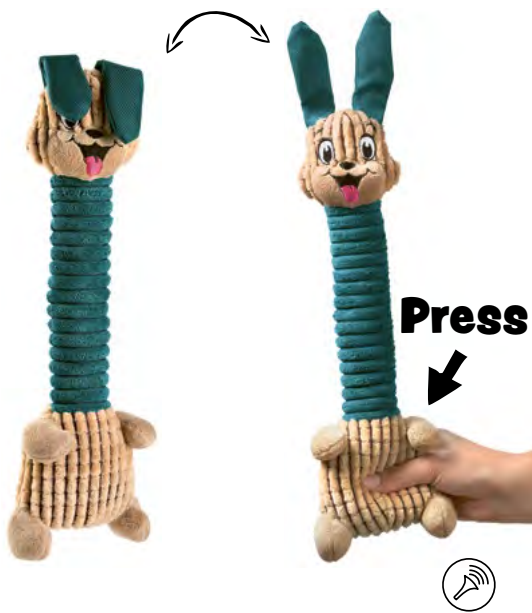

Hundespielzeug GRANBY

Dog toy | Jouet pour chiens | Juguete para perros | Giocattolo per cani | Hundelegetøj

Polyester, mit Squeaker | Polyester, with squeaker | Polyester, avec couineur | Poliéster, con sonido | Poliestere, con squeaker | Polyester, med squeaker

türkis | turquoise | turquoise | turquesa | turchese | turkis

38 cm 67452

III
3 Stck. | pcs.



Mit innenliegendem, spürbarem Noppenball
Ball inside with noticeable knobs



III
3 Stck. | pcs.



III
3 Stck. | pcs.

Hundspielzeug PORI

Dog toy | Jouet pour chiens | Juguete para perros | Giocattolo per cani | Hundelegetoj

Polyester/Latex, mit Igelball, mit Squeaker, waschbar bei 30 °C |

Polyester/Latex, with spike ball, with squeaker, washable at 30 °C |

Polyester/Latex, avec balle de hérisson, avec couineur, lavable à 30 °C |

Poliéster/Látex, con bola de erizo, con sonido, lavable a 30 °C | Poliestere/

Lattice, con palla di riccio, con squeaker, lavabile a 30 °C | Polyester/

Latex, med pindsvinbold, med squeaker, vaskbar ved 30 °C

1: Hund | Dog | Chien | Perro | Cane | Hund

17 cm 67754 20 cm 67757

2: Kuh | Cow | Vache | Vacca | Mucca | Ko

16 cm 67755 18 cm 67758

3: Elefant | Elephant | Éléphant | Elefante | Elefante | Elefant

18 cm 67756 21 cm 67759

Hundspielzeug TERNI

Dog toy | Jouet pour chiens | Juguete para perros | Giocattolo per cani | Hundelegetoj

Polyester, mit Squeaker | Polyester, with squeaker | Polyester, avec

couineur | Poliéster, con sonido | Poliestere, con squeaker | Polyester, med squeaker

1: Schaf | Sheep | Mouton | Oveja | Pecora | Får

29 cm 67454

2: Affe | Monkey | Singe | Mono | Scimmia | Abe

30 cm 67455

3: Hase | Rabbit | Lièvre | Liebre | Lepre | Hare

32 cm 67456



Hundenspielzeug MULI

Dog toy | Jouet pour chiens | Juguete para perros | Giocattolo per cani | Hundelegetøj

Polyester, Füllung: Baumwolle, mit Squeaker, bei 30°C waschbar | Polyester, filling: cotton, with squeaker, washable at 30°C | Polyester, rembourrage : coton, avec couineur, lavable à 30°C | Poliéster, relleno: algodón, con sonido, lavable a 30°C | Poliester, imbottitura: cotone, con squeaker, lavabile a 30°C | Polyester, Fyld: Bomuld, med squeaker, vaskbar ved 30°C

1: Elefant | Elephant | Éléphant | Elefante | Elefante | Elefant

18 cm 67751 

2: Löwe | Lion | Lion | León | Leone | Løve

18 cm 67752 

3: Hase | Rabbit | Lièvre | Liebre | Lepre | Hare

18 cm 67753 

III
3 Stck. | pcs.



Hundenspielzeug BELEM

Dog toy | Jouet pour chiens | Juguete para perros | Giocattolo per cani | Hundelegetøj

Polyester, innenliegendes Knotenseil, bei 30°C waschbar | Polyester, internal knotted rope, washable at 30°C | Polyester, corde à nœuds à l'intérieur, lavable à 30°C | Poliéster, cuerda anudada en el interior, lavable a 30°C | Poliester, corda annodata internamente, lavabile a 30°C | Polyester, indvendigt knyttet reb, kan vaskes ved 30°C

1: Donut | Donut | Donut | Donut | Ciambella | Donut

16 cm 204997 

2: Brezel | Pretzel | Bretzel | Pretzel | Pretzel | Saltkringle

19 cm 205000 

3: Croissant

20 cm 205003 

4: Baguette

30 cm 205006 

III
3 Stck. | pcs.



Innenliegendes Knotenseil

Internal knotted rope





III
3 Stck. | pcs.

Hundespielzeug FARO

Dog toy | Jouet pour chiens | Juguete para perros | Giocattolo per cani | Hundelegetoj

Polyester | Polyester | Polyester | Poliéster | Poliestere | Polyester

1: Bär | Bear | Ours | Oso | Orso | Björn

17 cm 67448

2: Schwein | Pig | Cochon | Cerdo | Porco | Svin

28 cm 67449

3: Elefant | Elephant | Éléphant | Elefante | Elefante | Elefant

19 cm 67450

4: Hund | Dog | Chien | Perro | Cane | Hund

19 cm 67451



III
3 Stck. | pcs.

Hundespielzeug BIRKA

Dog toy | Jouet pour chiens | Juguete para perros | Giocattolo per cani | Hundelegetoj

Polyester, mit Squeaker | Polyester, with squeaker | Polyester, avec squeaker | Poliéster, con chirriador | Poliestere, con squeaker | Polyester, med pibeclap

1: Reh | Deer | Chevreuil | Ciervos | Cervo | Hjort

27 cm 204377

2: Bär | Bear | Ours | Oso | Orso | Björn

27 cm 204380





III
3 Stck. | pcs.

Hundenspielzeug WILDLIFE

Dog toy | Jouet pour chiens | Juguete para perros | Giocattolo per cani | Hundelegetøj

Polyester, mit Plüsch, mit Squeaker, bei 30°C waschbar | *Polyester, with Plush, with squeaker, washable at 30°C* | Polyester, avec Peluche, avec couineur, lavable à 30°C | *Poliéster, con Felpa, con sonido, lavable a 30°C* | Poliestere, con Peluche, con squeaker, lavabile a 30°C | *Polyester, med Plys, med squeaker, vaskbar ved 30°C*

1: Training Duck

26 cm 44546

2: Training Squirrel

30 cm 44544

3: Kaninchen | Rabbit | Lapin | Conejito | Coniglio | Kanin

24 cm 46180

4: Ratte | Rat | Raton | Rata | Ratto | Rotte

20 cm 44538



III
3 Stck. | pcs.

Hundenspielzeug SNUGLY

Dog toy | Jouet pour chiens | Juguete para perros | Giocattolo per cani | Hundelegetøj

Polyester, mit Squeaker, bei 30°C waschbar | *Polyester, with squeaker, washable at 30°C* | Polyester, avec couineur, lavable à 30°C | *Polyester, con sonido, lavable a 30°C* | Poliestere, con squeaker, lavabile a 30°C | *Polyester, med squeaker, vaskbar ved 30°C*

17 cm 91805





III
3 Stck. | pcs.

Schlitze zum Befüllen mit Snacks* für die Nasenarbeit.
Kann Demenz vorbeugen!
Slots to fill with snacks* for nose work. Can prevent dementia!

Hundenspielzeug VENICE

Dog toy | Jouet pour chiens | Juguete para perros | Giocattolo per cani | Hundelegetøj

Polyester, Zerrspielzeug mit Schlitzen für Nasenarbeit (kann Demenz vorbeugen), befüllbar mit Snacks*, verstärkt mit Gurt, für große und kleine Hunde, bei 30°C waschbar | Polyester, tug toy with slits for nose work (can prevent dementia), can be filled with snacks, reinforced with strap, for large and small dogs, washable at 30°C | Polyester, jouet à déchirer avec fentes pour le travail du nez (peut prévenir la démence), peut être rempli de friandises, renforcé par une sangle, pour grands et petits chiens, lavable à 30°C | Poliéster, juguete de tracción con aberturas para trabajar la nariz (puede prevenir la demencia), se puede rellenar con snacks, reforzado con correa, para perros grandes y pequeños, lavable a 30°C | Poliestere, gioco da tiro con fessure per il naso (può prevenire la demenza), può essere riempito di snack, rinforzato con laccetto, per cani grandi e piccoli, lavabile a 30° | Polyester, trækkelegetøj med slider til næsarbejde (kan forebygge demens), kan fyldes med snacks, forstærket med strop, til store og små hunde, kan vaskes ved 30°C

1: Kürbis | Pumpkin | Courge | Calabaza | Zucca | Græskar

22 cm 207071

2: Birne | Pear | Poire | Pera | Pera | Pære

15 cm 207077

3: Zwiebel | Onion | Oignon | Cebolla | Cipolla | Løg

18 cm 207074

4: Mais | Maize | Maïs | Maíz | Mais | Majs

45 cm 207083

5: Karotte | Carrot | Carotte | Zanahoria | Carota | Gulerod

16 cm 207080

Zerrspielzeug
verstärkt mit Gurtband.
Tug toy reinforced
with webbing.



*außer bei der Karotte
does not apply to the carrot



III
3 Stck. | pcs.

Hundenspielzeug KOLOA

Dog toy | Jouet pour chiens | Juguete para perros | Giocattolo per cani | Hundelegetoj

Polyester, flacher Körper, sehr widerstandsfähig, mehrere Stofflagen, verstärkte Nähte, mit Knistergeräuschen | *Polyester, flat body, very resistant, several layers of fabric, reinforced seams, with crackling noises* | Polyester, corps plat, très résistant, plusieurs couches de tissu, coutures renforcées, avec bruits de crépitement | *Poliéster, cuerpo plano, muy resistente, varias capas de tejido, costuras reforzadas, con crujidos* | Poli-estere, corpo piatto, molto resistente, diversi strati di tessuto, cuciture rinforzate, con rumori di scricchiolio | *Polyester, flad krop, meget modstandsdygtig, flere lag stof, forstærkede sømme, med knitrende lyde*

1: John Lemon

25 cm 205009

2: Pigasso

24 cm 205012

3: Tearex

26 cm 205015

4: Shakespear

24 cm 205018

**Sehr widerstandsfähiges
Flachspielzeug mit verstärkten Nähten**
Very durable flat toy with reinforced seams

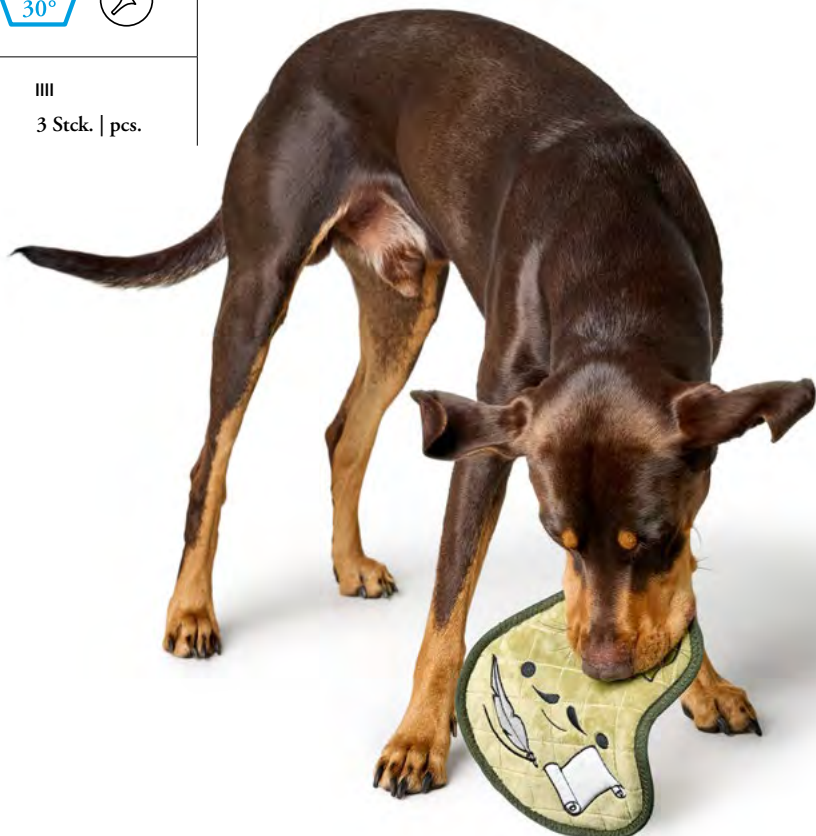



XXL

III
3 Stck. | pcs.

Hundespielzeug CLEVELAND

Dog toy | Jouet pour chiens | Juguete para perros | Giocattolo per cani | Hundelegetøj

Polyester, mit Squeaker | Polyester, with squeaker, | Polyester, avec squeaker | Poliéster, con squeaker | con squeaker | med squeaker

bordeaux | bordeaux | bordeaux | burdeos | bordò | bordeaux

20 cm 207489  40 cm 207483 

grün | green | vert | verde | verde | grøn

20 cm 207492  40 cm 207486 



Hundesofa CLEVELAND

Dog sofa





ERSTMALS: Stoffspielzeuge mit Schleuder-Stab

For the first time: fabric toys with slingshot rod



Ermöglicht einfache Aufnahme
des Spielzeugs ohne sich die
Hände schmutzig zu machen
*Makes it easy to pick up the toy
without getting your hands dirty*

Besonders weites Schleudern
des Spielzeugs ohne großen
Kraftaufwand möglich
*Particularly wide spinning of the toy
Possible without great effort*

Einfachste Handhabung
Simplest handling

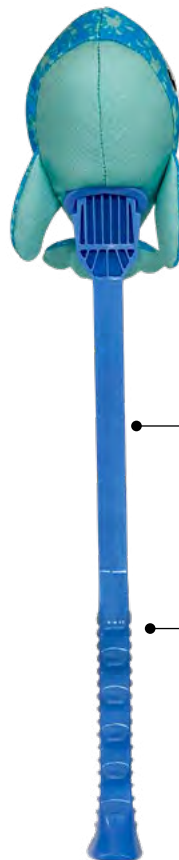

Spielzeug kann einfach
aufgesteckt werden
*Toy can simply be
plugged in*

Schleuderstab passend
für alle Spielzeuge
*Slingshot rod suitable for all
toys*

Für ausgelassenes
Apportierspiel
For exuberant fetch play

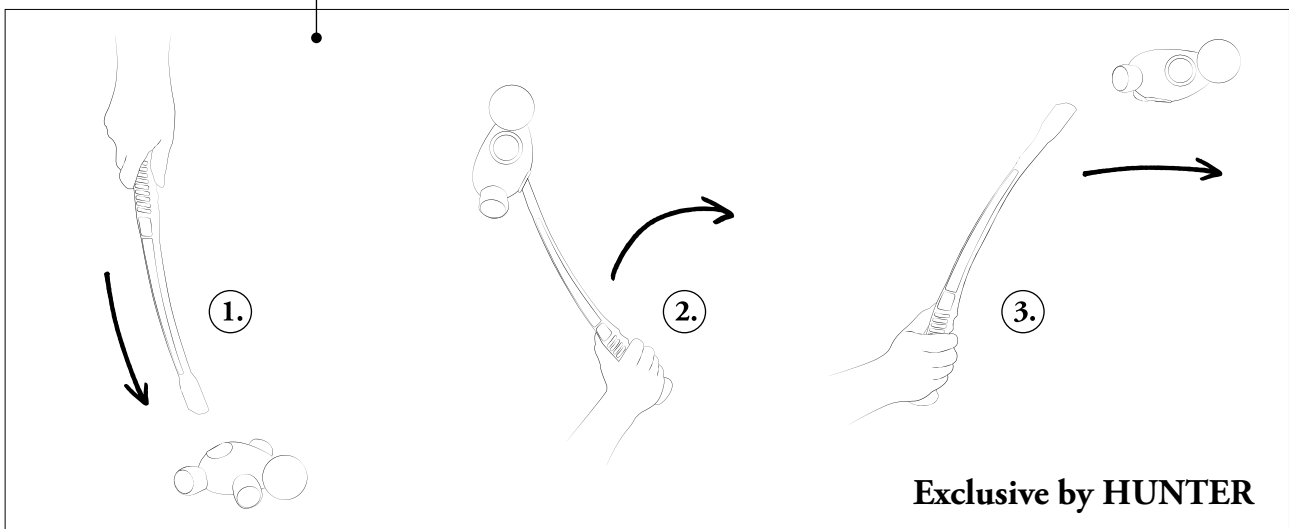

Exclusive by HUNTER

US Patent No.: US8973564, D658243, D660284, D834661, other patents pending



47 cm
Gesamtlänge
total length



III
4 Stck. | pcs.

Wurf-Hundespielzeug FLINGERZ™ BALL

Fetch toy for dogs | Jouet à rapporter pour chiens | Juguete para perros | Giocattolo da recuperare per cani | Fetch legetøj til hunde

Gummi, mit Wurf Schleuder (ABS), befüllbar mit Snacks, erzeugt Pfeifgeräusche in der Luft, schwimmfähig | Rubber, with launcher (ABS), can be filled with snacks, produces whistling sounds in the air, floatable | Caoutchouc, avec lanceur (ABS), peut être rempli de friandises, émet des sifflements dans l'air, flotante | De goma, con catapulta (de plástico - a especificar), se puede rellenar con aperitivos, produce silbidos en el aire, flotante | In gomma, con catapulta (in plastica - da specificare), può essere riempito di snack, produce suoni fischianti nell'aria, galleggiante | Gummi, med katapult (plast - skal specificeres), kan fyldes med snacks, giver fløjttende lyde i luften, kan flydende

7 cm 69517



III
2 x 4 Stck.

Ersatzbälle für Wurf Schleuder FLINGERZ™

Spare balls for launcher | Boules de rechange pour le lanceur | Bolas de repuesto para el lanzador | Palline di ricambio per il lanciatore | Ekstra kugler til loftteraket

Gummi, befüllbar mit Snacks, erzeugt Pfeifgeräusche in der Luft, ein Original-Ball, ein Ball leuchtet im Dunkeln, schwimmfähig | Rubber, can be filled with snacks, produces whistling sounds in the air, one original ball, one ball glows in the dark, floatable | Caoutchouc, peut être rempli de friandises, émet des sifflements dans l'air, une balle originale, une balle qui brille dans le noir, flotante | De goma, se puede rellenar con aperitivos, produce silbidos en el aire, una bola original, una bola que brilla en la oscuridad, flotante | In gomma, può essere riempito di snack, produce suoni fischianti nell'aria, una palla originale, una palla che si illumina al buio, galleggiante | Gummi, kan fyldes med snacks, giver fløjttende lyde i luften, en original kugle, en kugle lyser i mørke, kan flydende

7 cm 69518

Enthält | Includes:
1 Original-Ball | original ball
1 Nachtspiel-Ball | night play ball



III
4 Stck. | pcs.



III
4 Stck. | pcs.

Wurf-Hundespielzeug FLINGERZ™ FUNKI

Fetch toy for dogs | Jouet à rapporter pour chiens | Juguete para perros | Giocattolo da recuperare per cani | Fetch legetøj til hunde

Polyester/ballistisches Nylon, mit Wurf Schleuder (ABS), mit Squeaker, bei 30°C waschbar | Polyester/ballistic nylon, with launcher (ABS), with squeaker, washable at 30°C | Polyester/nylon balistique, avec lanceur (ABS), avec squeaker, lavable à 30°C | Poliéster/nylon balístico, con catapulta (plástico - a especificar), con chirriador, lavable a 30°C | Poliestere/nylon balistico, con catapulta (in plastica - da specificare), con squeaker, lavabile a 30° | Polyester/ballistisk nylon, med katapult (plastik - skal specificeres), med pivtøj, vaskbar ved 30°C

1: Biene | Bee | Abeille | Abeja | Ape | Bi

16 cm 69525

2: Marienkäfer | Ladybird | Coccinelle | Mariquita | Coccinella | Mariehøne

17 cm 69526

3: Grashüpfer | Grasshopper | Sauterelle

22 cm 69527

Wurf-Hundespielzeug FLINGERZ™ FURRY

Fetch toy for dogs | Jouet à rapporter pour chiens | Juguete para perros | Giocattolo da recuperare per cani | Fetch legetøj til hunde

Polyester/ballistisches Nylon, mit Wurf Schleuder (ABS), mit Squeaker, bei 30°C waschbar | Polyester/ballistic nylon, with launcher (ABS), with squeaker, washable at 30°C | Polyester/nylon balistique, avec lanceur (ABS), avec squeaker, lavable à 30°C | Poliéster/nylon balístico, con catapulta (ABS), con chirriador, lavable a 30°C | Poliestere/nylon balistico, con catapulta (in plastica - da specificare), con squeaker, lavabile a 30° | Polyester/ballistisk nylon, med katapult (plastik - skal specificeres), med pivtøj, vaskbar ved 30°C

1: Eichhörnchen | Squirrel | Écureuil | Ardilla | Scoiattolo | Egern

22 cm 69519

2: Ente | Duck | Canard | Pato | Anatra | And

21 cm 69520

3: Hase | Rabbit | Lièvre | Liebre | Lepre | Hare

19 cm 69521



Wurf-Hundespielzeug FLINGERZ™ SPLASH

Fetch toy for dogs | Jouet à rapporter pour chiens | Juguete para perros | Giocattolo da recuperare per cani | Fetch legetøj til hunde

Neopren, mit Wurf Schleuder (ABS), mit Squeaker, schwimmfähig, bei 30°C waschbar | Neoprene, with launcher (ABS), with squeaker, floatable, washable at 30°C | Néoprène, avec lanceur (ABS), avec squeaker, flotante, lavable à 30°C | Neopreno, con catapulta (plástico - a especificar), con chirriador, flotante, lavable a 30°C | Neoprene, con catapulto (in plastica - da specificare), con squeaker, galleggiante, lavabile a 30°C | Neopren, med katapult (plast - skal specificeres), med pivtøj, flydende, vaskbar ved 30 °C

1: Wal | Whale | Baleine | Ballena | Balena | Hval

18 cm 69522 

2: Hai | Shark | Requin | Tiburón | Squalo | Haj

23 cm 69523 

3: Schildkröte | Turtle | Tortue | Tortuga | Tartaruga | Skildpadde

19 cm 69524 



III
4 Stck. | pcs.

Schleuderstab passend für alle Spielzeuge Launcher suitable for all toys

Der patentierte Schleuderstab ermöglicht ein rückenfreundliches Aufnehmen des Spielzeugs vom Boden und auch die Hände bleiben dabei sauber. Außerdem ermöglicht er einen besonders weiten Wurf des Spielzeugs auch ohne großen Kraftaufwand.

The patented launcher stick makes it easy to pick up the toy from the ground and keep your hands clean. It also allows the toy to be thrown particularly far, even without much effort.

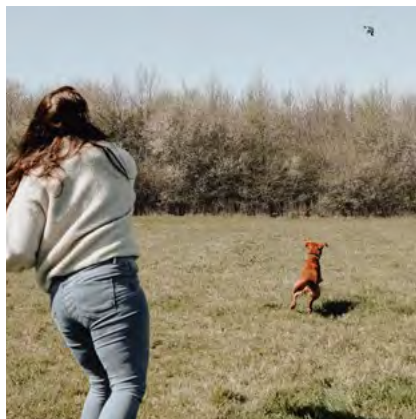
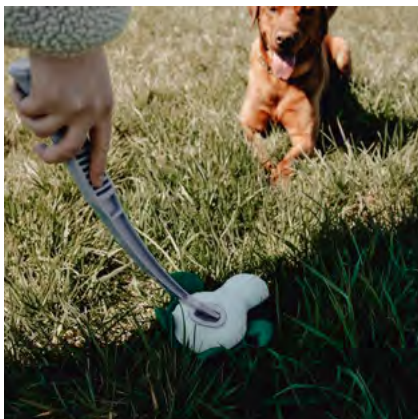





KONG®

KONG® – das ist das bewährte und allseits beliebte Hundespielzeug aus robustem Naturkautschuk. Ob mit Wurftau, für Welpen oder ältere Hunde, ob schwimmfähig oder in der klassischen Version – die KONG®s bieten für jeden Hund den geeigneten Spielspaß. Viele KONG®-Artikel können auch mit Snacks befüllt werden und sorgen für abwechslungsreiche Beschäftigung für jeden Hund.

KONG® – that is the well-proven and popular toy made from natural rubber. Whether with rope for throwing, for puppies or for seniors, whether floating or in the classical version – the KONG®s offer the right toy for every dog. Many KONG® articles can also be filled with snacks and provide varied occupation for every dog.



KONG® Classic

-  Hunde mit durchschnittlichem Kauvermögen
Average Chewers
-  Konzipiert für die meisten ausgewachsenen Hunde
Designed for most adult dogs
-  Robuster Naturkautschuk
Durable Rubber
-  Rot
red



⇒	■	
XS	5,5 cm	4 Stck. pcs.
S	7,0 cm	4 Stck. pcs.
M	8,5 cm	4 Stck. pcs.
L	10 cm	3 Stck. pcs.
XL	13 cm	2 Stck. pcs.
XXL	15 cm	2 Stck. pcs.

Hundenspielzeug KONG® CLASSIC

Dog toy | Jouet pour chiens | Juguete para perros | Giocattolo per cani | Hundelegetøj

Naturkautschuk, befüllbar mit Snacks | *Natural rubber, can be filled with snacks* | Caoutchouc naturel, à remplir de friandises | *Caucho natural, se puede rellenar con comida* | Caucciù naturale, si può riempire con snack | *Naturkautsjuk, kan fyldes med godbidder*

rot | red | rouge | rojo | rosso | rød

XS	68846		S	41889	
M	41937		L	41938	
XL	41939		XXL	68847	



Passend für KONGs Gr. S – XXL
Suitable for KONGs size S - XXL



Reinigungsbürste KONG® BRUSH

Cleaning brush | Brosse de nettoyage | Cepillo de limpieza | Spazzola di pulizia | Rengøringsbørste

PP/Silikon, geeignet zum Reinigen des KONG® Classic S-XXL, antimikrobiell, schimmelbeständig, BPA-frei | *PP/silicone, suitable for cleaning the KONG® Classic S-XXL, antimicrobial, mould-resistant, BPA-free* | PP/silicone, convient pour nettoyer le KONG® Classic S-XXL, antimicrobien, résistant aux moisissures, sans BPA | *PP/silicona, adecuado para limpiar el KONG® Classic S-XXL, antimicrobiano, resistente al moho, sin BPA* | PP/silicone, adatto per la pulizia del KONG® Classic S-XXL, antimicrobico, resistente alle muffe, senza BPA | *PP/silikone, egnet til rengøring af KONG® Classic S-XXL, antimikrobiel, skimmelresistent, BPA-fri*

18 cm 69537



Nicht zur Anwendung an Tieren!
Not for use on pets!



Reinige Deinen KONG®
Clean your KONG®

|||
4 Stck. | pcs.



60 cm / 63 cm
Gesamtlänge
total length



⇒	■	
M	8,5 cm	4 Stck. pcs.
L	10 cm	3 Stck. pcs.



60 cm / 63 cm
Gesamtlänge
total length



⇒	■	
M	8,5 cm	4 Stck. pcs.
L	10 cm	3 Stck. pcs.



|||
3 Stck. | pcs.

Hundespielzeug KONG® CLASSIC WITH ROPE

Dog toy | Jouet pour chiens | Juguete para perros | Giocattolo per cani | Hundelegetoj

Naturkautschuk, mit Tau | *Natural rubber, with rope* | Caoutchouc naturel, avec corde | *Caucho natural, con cuerda* | Caucciù naturale, con corda | *Naturkautsjuk, med tov*

rot | red | rouge | rojo | rosso | rød

M 66420 L 66419

Hundespielzeug KONG® AQUA

Dog toy | Jouet pour chiens | Juguete para perros | Giocattolo per cani | Hundelegetoj

Naturkautschuk, mit Tau, schwimmfähig | *Natural rubber, with rope, floating* | Caoutchouc naturel, avec corde, nageant | *Caucho natural, con cuerda, flotante* | Caucciù naturale, con corda, galleggiante | *Naturkautsjuk, med tov, svømmende*

orange | orange | orange | naranja | arancione | orange

M 41946 L 41947

Hundespielzeug KONG® RING

Dog toy | Jouet pour chiens | Juguete para perros | Giocattolo per cani | Hundelegetoj

Naturkautschuk | *Natural rubber* | Caoutchouc naturel | *Caucho natural* | Caucciù naturale | *Naturkautsjuk*

rot | red | rouge | rojo | rosso | rød

8 cm 66431 11 cm 66430

13 cm 67380



IIII
2 Stck. | pcs.

Hundespielzeug KONG® BOUNZER™

Dog toy | Jouet pour chiens | Juguete para perros | Giocattolo per cani | Hundelegetøj

SBS, überdimensioniert, leicht, springt immer wieder in die normale, typische KONG-Form zurück sobald der Hund loslässt, lässt sich leicht werfen dank praktischem Griff an der Oberseite | *SBS, oversized, lightweight, re-inflates back to normal, typical KONG shape as soon as the dog lets go, easy to throw thanks to practical handle on top* | SBS, surdimensionné, léger, reprend toujours sa forme normale typique de KONG dès que le chien le lâche, se lance facilement grâce à la poignée pratique sur le dessus | *SBS, sobredimensionado, ligero, siempre vuelve a la forma normal y típica de KONG en cuanto el perro lo suelta, fácil de lanzar gracias a la práctica asa de la parte superior* | SBS, sovradimensionato, leggero, torna sempre alla forma normale, tipica di KONG, non appena il cane lo lascia andare, facile da lanciare grazie alla pratica maniglia in alto | *SBS, overdimensioneret, let, springer altid tilbage til den normale, typiske KONG-form, så snart hunden giver slip, let at kaste takket være det praktiske håndtag på oversiden*

20 cm 61581

Kern aus Sand für
»Stehaufmännchen«
Funktion

*Core of sand for
»tumbler« function*



Hundespielzeug KONG® WOBBLER™

Dog toy | Jouet pour chiens | Juguete para perros | Giocattolo per cani | Hundelegetøj

PP/Sand, Intelligenzspielzeug für Hunde, befüllbar mit Snacks, das Tier kann sich selbst für das Lösen der Aufgabe belohnen, spülmaschinengeeignet | *PP/Sand, Interactive toy for dogs, can be filled with snacks, which the animal can earn by completing a task, dishwasher-safe* | PP/Sable, Jouet éducatif pour chiens, à remplir de friandises, le animal se récompense lui-même après avoir résolu l'exercice, lavable au lave-vaisselle | *PP/Arena, Juguete de inteligencia para perros, se puede rellenar con comida, el animal recibe por sí mismo la recompensa cuando resuelve la tarea, seguro para el lavavajillas* | PP/Sabbia, Giocattolo d'intelligenza per cani, si può riempire con snack, il animale può ricompensarsi da solo per la risoluzione dell'esercizio, lavabile in lavastoviglie | *PP/Sand, Intelligenslegetøj til hunde, kan fyldes med godbidder, dyret kan selv belønne sig efter at have løst opgaven, tåler opvaskemaskine*

rot | red | rouge | rojo | rosso | rød

15 cm 47749 19 cm 47522



IIII
4 Stck. | pcs.

Hundespielzeug KONG® FLYER

Dog toy | Jouet pour chiens | Juguete para perros | Giocattolo per cani | Hundelegetøj

Naturkautschuk, flexibel, besonders weich, hervorragendes Flugverhalten | *Natural rubber, flexible, soft formula, accurate flight* | Caoutchouc naturel, flexible, particulièrement doux, vol précis | *Caucho natural, flexible, especialmente blando, vuelo preciso* | Caucciù naturale, flessibile, particolarmente morbido, lancio preciso | *Naturkautsjuk, fleksibelt, superblødt, akkurat flyvebane*

rot | red | rouge | rojo | rosso | rød

18 cm 62017 23 cm 42551



■ 33 x 11 cm IIII 4 Stck. | pcs.

Hundespielzeug KONG® Tug Toy

Dog toy | Jouet pour chiens | Juguete para perros | Giocattolo per cani | Hundelegetøj

Naturkautschuk, bestens geeignet für Zerrspiele, sowie zum Werfen und Apportieren | *Natural rubber, really good for playing tug of war, as well as for throwing and carrying* | Caoutchouc naturel, convient parfaitement aux jeux au cours desquels le chien tire sur le jouet, que le jouet est lancé et rapporté | *Caucho natural, especialmente indicado para juegos de arrastre, así como tirar y portar* | Caucciù naturale, ideale da tirare, lanciare e per il riporto | *Naturkautsjuk, meget velegnet til ruskelege samt til kast og apport*

rot | red | rouge | rojo | rosso | rød

46593 



⇒ Ø IIII
S 6,0 cm 3 Stck. | pcs.
L 7,5 cm 2 Stck. | pcs.

Hundespielzeug KONG® BALL

Dog toy | Jouet pour chiens | Juguete para perros | Giocattolo per cani | Hundelegetøj

Naturkautschuk, befüllbar mit Snacks | *Natural rubber, can be filled with snacks* | Caoutchouc naturel, à remplir de friandises | *Caucho natural, se puede rellenar con comida* | Caucciù naturale, si può riempire con snack | *Naturkautsjuk, kan fylles med godbidder*

rot | red | rouge | rojo | rosso | rød

S 65015  L 65018 



⇌ ■ IIII
S 13,0 cm 4 Stck. | pcs.
M 18,0 cm 3 Stck. | pcs.

Hundespielzeug KONG® GOODIE BONE™

Dog toy | Jouet pour chiens | Juguete para perros | Giocattolo per cani | Hundelegetøj

Naturkautschuk, befüllbar mit Snacks | *Natural rubber, can be filled with snacks* | Caoutchouc naturel, à remplir de friandises | *Caucho natural, se puede rellenar con comida* | Caucciù naturale, si può riempire con snack | *Naturkautsjuk, kan fylles med godbidder*

rot | red | rouge | rojo | rosso | rød

S 65023  M 65022 



Hundespielzeug KONG® BISCUIT BALL™

Dog toy | Jouet pour chiens | Juguete para perros | Giocattolo per cani | Hundelegetøj

Naturkautschuk, befüllbar mit Snacks | *Natural rubber, can be filled with snacks* | Caoutchouc naturel, à remplir de friandises | *Caucho natural, se puede rellenar con comida* | Caucciù naturale, si può riempire con snack | *Naturkautsjuk, kan fyldes med godbidder*

rot | red | rouge | rojo | rosso | rød

7 cm 42533 



III
4 Stck. | pcs.



Hundespielzeug KONG® DENTAL STICK™

Dog toy | Jouet pour chiens | Juguete para perros | Giocattolo per cani | Hundelegetøj

Naturkautschuk, Denta-Ridges können mit Paste gefüllt werden, kann bei der Zahnreinigung unterstützen | *Natural rubber, Denta-Ridges can be filled with paste, can help to clean teeth* | Caoutchouc naturel, les Denta-Ridges peuvent être remplis de pâte, peut aider à nettoyer les dents | *Caucho natural, Denta-Ridges puede ser llenado con pasta, complementa la limpieza dental* | Caucciù naturale, Denta-Ridges può essere riempito con pasta, può aiutare nella pulizia bucale | *Naturkautsjuk, Denta-kamme kan fyldes med pasta, kan understøtte tandrensning*

rot | red | rouge | rojo | rosso | rød

M 41987  L 41988 



⇒  III
M 9 cm 4 Stck. | pcs.
L 12 cm 3 Stck. | pcs.



Hundespielzeug KONG® DENTAL WITH ROPE

Dog toy | Jouet pour chiens | Juguete para perros | Giocattolo per cani | Hundelegetøj

Naturkautschuk, mit Tau, Denta-Ridges können mit Paste gefüllt werden, kann bei der Zahnreinigung unterstützen | *Natural rubber, with rope, Denta-Ridges can be filled with paste, can help to clean teeth* | Caoutchouc naturel, avec corde, les Denta-Ridges peuvent être remplis de pâte, peut aider à nettoyer les dents | *Caucho natural, con cuerda, Denta-Ridges puede ser llenado con pasta, complementa la limpieza dental* | Caucciù naturale, con corda, Denta-Ridges può essere riempito con pasta, può aiutare nella pulizia bucale | *Naturkautsjuk, med tov, Denta-kamme kan fyldes med pasta, kan understøtte tandrensning*

rot | red | rouge | rojo | rosso | rød

8 cm 42542  12 cm 42543 



III
4 Stck. | pcs.



⇒	■i	
S	7,0 cm	4 Stck. pcs.
M	8,5 cm	4 Stck. pcs.
L	10 cm	3 Stck. pcs.
XL	13 cm	2 Stck. pcs.
XXL	15 cm	2 Stck. pcs.

Hundespielzeug KONG® EXTREME

Dog toy | Jouet pour chiens | Juguete para perros | Giocattolo per cani | Hundelegetoj

Naturkautschuk, befüllbar mit Snacks, für stark kauende Hunde | *Natural rubber, can be filled with snacks, for extreme chewing dogs* | Caoutchouc naturel, à remplir de friandises, pour mâcher fortement des chiens | *Caucho natural, se puede rellenar con comida, para fuertemente masticar perros* | Caucciù naturale, si può riempire con snack, per cani con forte istinto a mordere | *Naturkautsjuk, kan fylles med godbidder, til stærkt tyggende hunde*

schwarz | black | noir | negro | nero | sort

S	62012		M	62013	
L	41940		XL	41941	
XXL	41942				



||||
3 Stck. | pcs.

Hundespielzeug KONG® EXTREME GOODIE RIBBON™

Dog toy | Jouet pour chiens | Juguete para perros | Giocattolo per cani | Hundelegetoj

Naturkautschuk, befüllbar mit Snacks, besonders robust | *Natural rubber, can be filled with snacks, extremely robust* | Caoutchouc naturel, à remplir de friandises, particulièrement robuste | *Caucho natural, se puede rellenar con comida, especialmente resistente* | Caucciù, si può riempire con snack, particolarmente robusto | *Naturkautsjuk, kan fylles med godbidder, særlig robust*

schwarz | black | noir | negro | nero | sort

18 cm	68837		22 cm	68842	
-------	-------	--	-------	-------	--



||||
3 Stck. | pcs.

Hundespielzeug KONG® EXTREME GOODIE BONE™

Dog toy | Jouet pour chiens | Juguete para perros | Giocattolo per cani | Hundelegetoj

Naturkautschuk, befüllbar mit Snacks, besonders robust | *Natural rubber, can be filled with snacks, extremely robust* | Caoutchouc naturel, à remplir de friandises, particulièrement robuste | *Caucho natural, se puede rellenar con comida, especialmente resistente* | Caucciù naturale, si può riempire con snack, particolarmente robusto | *Naturkautsjuk, kan fylles med godbidder, særlig robust*

schwarz | black | noir | negro | nero | sort

18 cm	66406		21,5 cm	66407	
-------	-------	--	---------	-------	--



⇒	∅	
S	6 cm	3 Stck. pcs.
M/L	8 cm	2 Stck. pcs.

Hundespielzeug KONG® EXTREME BALL

Dog toy | Jouet pour chiens | Juguete para perros | Giocattolo per cani | Hundelegetøj

Naturkautschuk, befüllbar mit Snacks, besonders robust | *Natural rubber, can be filled with snacks, extremely robust* | Caoutchouc naturel, à remplir de friandises, particulièrement robuste | *Caucho natural, se puede rellenar con comida, especialmente resistente* | Caucciù naturale, si può riempire con snack, particolarmente robusto | *Naturkautsjuk, kan fylles med godbidder, særlig robust*

schwarz | black | noir | negro | nero | sort

S 62014 M/L 62015



3 Stck. pcs.

Hundespielzeug KONG® EXTREME RING

Dog toy | Jouet pour chiens | Juguete para perros | Giocattolo per cani | Hundelegetøj

Naturkautschuk, besonders robust | *Natural rubber, dental care, extremely robust* | Caoutchouc naturel, prend soin de dents, particulièrement robuste | *Caucho natural, cuida los dientes, especialmente resistente* | Caucciù, cura dentale, particolarmente robusto | *Naturkautsjuk, tandplejende, særlig robust*

schwarz | black | noir | negro | nero | sort

13 cm 68841



KONG®
EXTREME

- Hunde mit großem Kauvermögen
Power Chewers
- Konzipiert für extreme Kauer
Designed for extreme chewers
- Robustester Naturkautschuk
Most Durable Rubber
- Schwarz
Black





Hundespielzeug KONG® EXTREME DENTAL

Dog toy | Jouet pour chiens | Juguete para perros | Giocattolo per cani | Hundelegetoj

Naturkautschuk, befüllbar mit Snacks, kann bei der Zahnreinigung unterstützen, besonders robust | *Natural rubber, can be filled with snacks, can help to clean teeth, extremely robust* | Caoutchouc naturel, à remplir de friandises, peut aider à nettoyer les dents, particulièrement robuste | *Caucho natural, se puede rellenar con comida, complementa la limpieza dental, especialmente resistente* | Caucciù naturale, si può riempire con snack, può aiutare nella pulizia bucale, particolarmente robusto | *Naturkautsjuk, kan fylles med godbidder, kan understøtte tandrensning, særlig robust*

13 cm 68840 

IIII
2 Stck. | pcs.



Hundespielzeug KONG® EXTREME DENTAL WITH ROPE

Dog toy | Jouet pour chiens | Juguete para perros | Giocattolo per cani | Hundelegetoj

Naturkautschuk/Baumwolle, mit Tau, Denta-Ridges können mit Paste gefüllt werden, kann bei der Zahnreinigung unterstützen, besonders robust | *Natural rubber/Cotton, with rope, Denta-Ridges can be filled with paste, can help to clean teeth, extremely robust* | Caoutchouc naturel/Coton, avec corde, les Denta-Ridges peuvent être remplis de pâte, peut aider à nettoyer les dents, particulièrement robuste | *Caucho natural/Algodón, con cuerda, Denta-Ridges puede ser llenado con pasta, complementa la limpieza dental, especialmente resistente* | Caucciù/Cotone, con corda, Denta-Ridges può essere riempito con pasta, può aiutare nella pulizia bucale, particolarmente robusto | *Naturkautsjuk/Bomuld, med tov, Denta-kamme kan fylles med pasta, kan understøtte tandrensning, særlig robust*

12 cm 68838 

IIII
3 Stck. | pcs.



35 cm



Hundespielzeug KONG® EXTREME BALL WITH ROPE

Dog toy | Jouet pour chiens | Juguete para perros | Giocattolo per cani | Hundelegetoj

Naturkautschuk/Baumwolle, kann bei der Zahnreinigung unterstützen, besonders robust | *Natural rubber/Cotton, can help to clean teeth, extremely robust* | Caoutchouc naturel/Coton, peut aider à nettoyer les dents, particulièrement robuste | *Caucho natural/Algodón, complementa la limpieza dental, especialmente resistente* | Caucciù/Cotone, può aiutare nella pulizia bucale, particolarmente robusto | *Naturkautsjuk/Bomuld, kan understøtte tandrensning, særlig robust*

8 cm 68839 

IIII
2 Stck. | pcs.



III
4 Stck. | pcs.

Hundenspielzeug KONG® EXTREME FLYER

Dog toy | Jouet pour chiens | Juguete para perros | Giocattolo per cani | Hundelegetøj

Naturkautschuk, besonders robust, flexibel, weich, hervorragendes Flugverhalten | *Natural rubber, extremely robust, flexible, soft, accurate flight* | Caoutchouc naturel, particulièrement robuste, flexible, doux à rattraper, vol précis | *Caucho natural, especialmente resistente, flexible, fácil de atrapar, vuelo preciso* | Caucciù naturale, particolarmente robusto, flessibile, morbido, lancio preciso | *Naturkautsjuk, særlig robust, fleksibelt, blødt, akkurat flyvebane*

schwarz | black | noir | negro | nero | sort

25 cm 47692 



III
3 Stck. | pcs.

Hundenspielzeug KONG® TYRES™

Dog toy | Jouet pour chiens | Juguete para perros | Giocattolo per cani | Hundelegetøj

Naturkautschuk, befüllbar mit Snacks, besonders robust | *Natural rubber, can be filled with snacks, extremely robust* | Caoutchouc naturel, à remplir de friandises, particulièrement robuste | *Caucho natural, se puede rellenar con comida, especialmente resistente* | Caucciù naturale, si può riempire con snack, particolarmente robusto | *Naturkautsjuk, kan fylles med godbidder, særlig robust*

schwarz | black | noir | negro | nero | sort

11 cm 65011 





assorted colours

4 Stck. | pcs.



assorted colours

4 Stck. | pcs.







assorted colours

2 Stck. | pcs.

Hundenspielzeug KONG® PUPPY

Dog toy | Jouet pour chiens | Juguete para perros | Giocattolo per cani | Hundelegetoj

Naturkautschuk, befüllbar mit Snacks, besonders weich, farblich sortiert | *Natural rubber, can be filled with snacks, soft formula, assorted colours* | Caoutchouc naturel, à remplir de friandises, particulièrement doux, couleurs assorties | *Caucho natural, se puede rellenar con comida, especialmente blando, colores surtidos* | Caucciù naturale, si può riempire con snack, particolarmente morbido, colori assortiti | *Naturkautsjuk, kan fyldes med godbidder, superblødt, farvemæssigt sorteret*

5,5 cm 201341  7 cm 41943 
8,5 cm 41944  10 cm 41945 

Hundenspielzeug KONG® PUPPY BINKIE™

Dog toy | Jouet pour chiens | Juguete para perros | Giocattolo per cani | Hundelegetoj

Naturkautschuk, befüllbar mit Snacks, besonders weich, farblich sortiert | *Natural rubber, can be filled with snacks, soft formula, assorted colours* | Caoutchouc naturel, à remplir de friandises, particulièrement doux, couleurs assorties | *Caucho natural, se puede rellenar con comida, especialmente blando, colores surtidos* | Caucciù naturale, si può riempire con snack, particolarmente morbido, colori assortiti | *Naturkautsjuk, kan fyldes med godbidder, superblødt, farvemæssigt sorteret*

12 cm 62597 





Hundenspielzeug KONG® PUPPY TIRES

Dog toy | Jouet pour chiens | Juguete para perros | Giocattolo per cani | Hundelegetoj

Naturkautschuk, befüllbar mit Snacks, besonders weich, farblich sortiert | *Natural rubber, can be filled with snacks, especially soft, assorted colours* | Caoutchouc naturel, peut être rempli de friandises, particulièrement doux, couleurs assorties | *Caucho natural, se puede rellenar con bocadillos, especialmente blandos, colores surtidos* | Gomma naturale, può essere riempita con snack, soprattutto se morbidi, colori assortiti | *Naturkautsjuk, kan fyldes med snacks, især bløde, farvemæssigt sorteret*

9 cm 201340 



-  **Hunde, die erstmals kauen, bzw. mit geringem Kauvermögen**
Beginning to Light Chewers
-  **Konzipiert für die Zähne und das Zahnfleisch von Welpen**
Designed for Puppy Teeth and gums
-  **Weichster Naturkautschuk**
Softest Rubber
-  **Blau und Rosa**
Blue & Pink

KONG®
Puppy



assorted colours

III
4 Stck. | pcs.

Hundespielzeug KONG® PUPPY GOODIE BONE™

Dog toy | Jouet pour chiens | Juguete para perros | Giocattolo per cani | Hundelegetøj

Naturkautschuk, befüllbar mit Snacks, farblich sortiert | *Natural rubber, can be filled with snacks, assorted colours* | Caoutchouc naturel, à remplir de friandises, couleurs assorties | *Caucho natural, se puede rellenar con comida, colores surtidos* | Cauciù naturale, si può riempire con snack, colori assortiti | *Naturkautsjuk, kan fyldes med godbidder, farvemæssigt sorteret*

13 cm 42539 



assorted colours

III
4 Stck. | pcs.

Hundespielzeug KONG® PUPPY GOODIE BONE™ WITH ROPE

Dog toy | Jouet pour chiens | Juguete para perros | Giocattolo per cani | Hundelegetøj

Naturkautschuk, mit Tau, farblich sortiert | *Natural rubber, with rope, assorted colours* | Caoutchouc naturel, avec corde, couleurs assorties | *Caucho natural, con cuerda, colores surtidos* | Cauciù naturale, con corda, colori assortiti | *Naturkautsjuk, med tov, farvemæssigt sorteret*

8 cm 65031 



assorted colours

III
4 Stck. | pcs.

Hundespielzeug KONG® PUPPY FLYER

Dog toy | Jouet pour chiens | Juguete para perros | Giocattolo per cani | Hundelegetøj

Naturkautschuk, besonders weich, flexibel, hervorragendes Flugverhalten, farblich sortiert | *Natural rubber, soft formula, flexible, accurate flight, assorted colours* | Caoutchouc naturel, particulièrement doux, flexible, vol précis, couleurs assorties | *Caucho natural, especialmente blando, flexible, vuelo preciso, colores surtidos* | Cauciù naturale, particolarmente morbido, flessibile, lancio preciso, colori assortiti | *Naturkautsjuk, superblødt, fleksibelt, akkurat flyvebane, farvemæssigt sorteret*

18 cm 62016 



III
3 Stck. | pcs.



assorted colours

Seitliche Griffe für einfaches
Aufgreifen und Schütteln
*handles for easy picking up
and shaking*



Hundespielzeug KONG® TWISTZ

Dog toy | Jouet pour chiens | Juguete para perros | Giocattolo per cani | Hundelegetøj

TPR, schwimmfähig | *TPR, floating* | TPR, nageant | *TPR, flotante* | TPR, galleggiante | *TPR, svømmende*

Ring | Ring | Anneau | Anilla | Anello | Ring

17 cm 68875 

Hundespielzeug KONG® JUMBLER™

Dog toy | Jouet pour chiens | Juguete para perros | Giocattolo per cani | Hundelegetøj

TPR/Gummi, 2-in-1 Ballspielzeug für doppelten interaktiven Spaß, mit Squeaker, Tennisball im Innern, farblich sortiert | *TPR/Rubber, 2-in-1 ball toy for twofold interactive fun and games, with squeaker, tennis ball inside, assorted colours* | TPR/Caoutchouc, Jeu de balle 2-en-1 pour un double plaisir interactif, avec couineur, balle de tennis à l'intérieur, couleurs assorties | *TPR/De goma, Pelota de juguete 2 en 1 para el doble de diversión interactiva, con sonido, pelota de tenis en el interior, colores surtidos* | TPR/Gomma piena, pallina giocattolo 2 in 1 per un divertimento due volte più interattivo, con squeaker, palla da tennis all'interno, colori assortiti | *TPR/Massiv gummi, 2-i-1 boldlegetøj for dobbelt interaktiv sjov, med squeaker, tennisbold i legetøjets indre, farvemæssigt sorteret*

Ball | Ball | Balle | Balón | Palla | Bold

14 cm 62656  18 cm 62655 

Hundespielzeug KONG® FLEXBALL

Dog toy | Jouet pour chiens | Juguete para perros | Giocattolo per cani | Hundelegetøj

TPR, besonders flexibel und formbeständig, für leises Spiel entwickelt | *TPR, particularly flexible and dimensionally stable, idesigned for quiet play* | TPR, particulièrement flexible et dimensionnellement stable, conçu pour le jeu silencieux | *TPR, particolarmente flessibile y dimensionalmente estable, diseñado para un juego tranquilo* | TPR, particolarmente flessibile e dimensionalmente stabile, progettato per un gioco silenzioso | *TPR, især fleksibel og dimensionelt stabil, udviklet til stille spil*

15 cm 68871 



Hundespielzeug KONG® SQUEEZZ® BALL

Dog toy | Jouet pour chiens | Juguete para perros | Giocattolo per cani | Hundelegetøj

TPR, mit Squeaker, farblich sortiert | *TPR, with squeaker, assorted colours* | TPR, avec squeaker, couleurs assorties | *TPR, con chirriador, colores surtidos* | TPR, con squeaker, colori assortiti | *TPR, med piver, farvemessigt sorteret*

7,5 cm 201374 

assorted colours

IIII
4 Stck. | pcs.



Hundespielzeug KONG® SQUEEZZ® ACTION

Dog toy | Jouet pour chiens | Juguete para perros | Giocattolo per cani | Hundelegetøj

TPR, mit Squeaker | *TPR, with squeaker* | TPR, avec couineur | *TPR, con sonido* | TPR, con squeaker | *TPR, med squeaker*

S 66429  M 66428 
L 66427 



⇒	■	IIII
S	5 cm	3 x 3 Stck. pcs.
M	6 cm	3 x 3 Stck. pcs.
L	8 cm	3 x 2 Stck. pcs.



Hundespielzeug KONG® SIGNATURE BALL

Dog toy | Jouet pour chiens | Juguete para perros | Giocattolo per cani | Hundelegetøj

TPR, mit Squeaker | *TPR, with squeaker* | TPR, avec couineur | *TPR, con sonido* | TPR, con squeaker | *TPR, med squeaker*

S 67388  M/VE3 67387 
M/VE12 67386  L 67385 

⇒	∅	IIII
S	5 cm	3 x 2 Stck.
M/VE3	6 cm	3 x 2 Stck.
M/VE12	6 cm	12 x 1 Stck.
L	8 cm	3 x 2 Stck.



Hundespielzeug KONG® SIGNATURE STICK

Dog toy | Jouet pour chiens | Juguete para perros | Giocattolo per cani | Hundelegetoj

Polyester/Baumwolle, mit Squeaker, mit Knistergeräuschen, mit Rasselgeräuschen | Polyester/cotton, with squeaker, with crackling sounds, with rattling sounds | Polyester/coton, avec squeaker, avec bruits de crépitement, avec bruits de hochet | Poliéster/algodón, con chirriador, con sonidos crepitantes, con sonidos de traqueteo | Poliester/cotone, con squeaker, con suoni scoppiettanti, con suoni sferraglianti | Polyester/bomuld, med piver, med knitrende lyde, med raslende lyde

45 cm 201370 

III
3 Stck. | pcs.



Hundespielzeug KONG® SIGNATURE STICK WITH ROPE

Dog toy | Jouet pour chiens | Juguete para perros | Giocattolo per cani | Hundelegetoj

Polyester/Baumwolle, mit Squeaker, mit Knistergeräuschen, mit Rasselgeräuschen, kann die Zahnreinigung unterstützen | Polyester/cotton, with squeaker, with crackling sounds, with rattling sounds, can support teeth cleaning | Polyester/coton, avec squeaker, avec bruits de crépitement, avec bruits de hochet, peut favoriser le nettoyage des dents | Poliéster/algodón, con chirriador, con sonidos crepitantes, con sonidos de traqueteo, puede ayudar a limpiar los dientes | Poliester/cotone, con squeaker, con suoni scoppiettanti, con suoni sferraglianti, può favorire la pulizia dei denti | Polyester/bomuld, med piver, med knitrende lyde, med raslende lyde, kan støtte tandrensning

30 cm 201344 

III
3 Stck. | pcs.



Hundespielzeug KONG® SIGNATURE CRUNCH ROPE SINGLE

Dog toy | Jouet pour chiens | Juguete para perros | Giocattolo per cani | Hundelegetoj

PVC/Polyester, mit Knackgeräuschen, dehnbares Strumpfmateriale | PVC/polyester, with pops, stretchy hosiery material | PVC/polyester, avec craquement, bas extensible | PVC/poliéster, con pops, material elástico de calcería | PVC/poliester, con pops, materiale di calzetteria elastic | PVC/polyester, med pops, strækbart strømpemateriale

50 cm 201372 

III
3 Stck. | pcs.



III
2 Stck. | pcs.



XXL



III
4 Stck. | pcs.

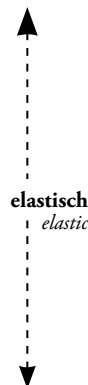
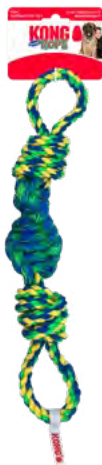

assorted colours

III
4 Stck. | pcs.

Hundenspielzeug KONG® SIGNATURE ROPE DOUBLE RING TUG

Dog toy | Jouet pour chiens | Juguete para perros | Giocattolo per cani | Hundelegetøj

Polyester/Baumwolle, besonders robust, geflochtenes Seil aus Baumwolle und Fleece, kann die Zahnreinigung unterstützen | Polyester/cotton, particularly robust, braided rope made of cotton and fleece, can support tooth cleaning | Polyester/coton, particulièrement résistant, corde tressée en coton et polaire, peut favoriser le nettoyage des dents | Cuerda trenzada de poliéster/algodón, especialmente robusta, de algodón y vellón, puede soportar la limpieza dental | Poliestere/cotone, particolarmente robusto, corda intrecciata in cotone e pile, può supportare la pulizia dei denti | Polyester/bomuld, særligt robust, flettet reb lavet af bomuld og fleece, kan støtte tandrensning

23 cm 201343

Hundenspielzeug KONG® SIGNATURE ROPE DUAL KNOT

Dog toy | Jouet pour chiens | Juguete para perros | Giocattolo per cani | Hundelegetøj

Polyester/Baumwolle, besonders robust, geflochtenes Seil aus Baumwolle und Fleece, kann die Zahnreinigung unterstützen | Polyester/cotton, particularly robust, braided rope made of cotton and fleece, can support tooth cleaning | Polyester/coton, particulièrement résistant, corde tressée en coton et polaire, peut favoriser le nettoyage des dents | Cuerda trenzada de poliéster/algodón, especialmente robusta, de algodón y vellón, puede soportar la limpieza dental | Poliestere/cotone, particolarmente robusto, corda intrecciata in cotone e pile, può supportare la pulizia dei denti | Polyester/bomuld, særligt robust, flettet reb lavet af bomuld og fleece, kan støtte tandrensning

57 cm 201373

Hundenspielzeug KONG® ROPE BUNJI

Dog toy | Jouet pour chiens | Juguete para perros | Giocattolo per cani | Hundelegetøj

Polyester/Baumwolle/Gummi, interaktives Zerrspielzeug mit Baumwollkordeln, elastisches Gummiseil im Inneren dämpft Ruckbewegungen, kann die Zahnreinigung unterstützen, farblich sortiert | Polyester/cotton/rubber, interactive tug toy with cotton cords, elastic rubber cord inside dampens jerking movements, can help clean teeth, assorted colours | Polyester/coton/caoutchouc, jouet à tirer interactif avec cordons en coton, corde élastique en caoutchouc à l'intérieur amortit les secousses, peut aider au nettoyage des dents, couleurs assorties | Poliéster/algodón/caucho, juguete interactivo con cordones de algodón, cordón elástico de caucho en el interior que amortigua los movimientos bruscos, puede ayudar a limpiar los dientes, colores surtidos | Poliestere/cotone/gomma, giocattolo interattivo con cordicelle di cotone, cordicella elastica in gomma all'interno che smorza i movimenti a scatti, può aiutare a pulire i denti, colori assortiti | Polyester/bomuld/gummi, interaktivt træklegetøj med bomuldssnore, elastisk gummisnor indeni demper rykkende bevægelser, kan hjælpe med at rense tænder, farvemæssigt sorteret

39 cm 201378 53 cm 201348



assorted colours

||||

3 Stck. | pcs.

Hundespielzeug KONG® ROPE BALL PUPPY

Dog toy | Jouet pour chiens | Juguete para perros | Giocattolo per cani | Hundelegetoj

Polyester, geflochtenes Tau, kann bei der Zahnreinigung unterstützen, farblich sortiert | Polyester, braided rope, can assist with tooth cleaning, assorted colours | Polyester, corde tressée, peut aider au nettoyage des dents, couleurs assorties | Cuerda trenzada de poliéster, puede ayudar a limpiar los dientes, colores surtidos | Poliestere, corda intrecciata, può aiutare nella pulizia dei denti, colori assortiti | Polyester, flettet reb, kan hjelpe med tandrensning, farvemessigt sorteret

7,5 cm 201371 



assorted colours

||||

3 Stck. | pcs.

Hundespielzeug KONG® ROPE TUG PUPPY

Dog toy | Jouet pour chiens | Juguete para perros | Giocattolo per cani | Hundelegetoj

Polyester, geflochtenes Tau, kann bei der Zahnreinigung unterstützen, farblich sortiert | Polyester, braided rope, can assist with tooth cleaning, assorted colours | Polyester, corde tressée, peut aider au nettoyage des dents, couleurs assorties | Cuerda trenzada de poliéster, puede ayudar a limpiar los dientes, colores surtidos | Poliestere, corda intrecciata, può aiutare nella pulizia dei denti, colori assortiti | Polyester, flettet reb, kan hjelpe med tandrensning, farvemessigt sorteret

30 cm 201347 



III
3 Stck. | pcs.

Hundenspielzeug KONG® MAXX

Dog toy | Jouet pour chiens | Juguete para perros | Giocattolo per cani | Hundelegetøj

PE/Polyester, besonders robust, mit Squeaker | *PE/polyester, particularly robust, with squeaker* | PE/polyester, particulièrement robuste, avec squeaker | *PE/poliéster, particularmente robusto, con chirriador* | PE/poliestere, particolarmente robusto, con squeaker | *PE/polyester, særligt robust, med pivtøj*

1: Knochen | Bone | Os | Hueso | Osso | Knogle

23,5 cm 201338

2: Stick

41 cm 69539

3: Stern | Star | Étoile | Estrella | Stella | Stjerne

20 cm 201362



III
4 Stck. | pcs.



III
3 Stck. | pcs.





III
4 Stck. | pcs.

Hundenspielzeug KONG® CORESTRENGTH™ BALL

Dog toy | Jouet pour chiens | Juguete para perros | Giocattolo per cani | Hundelegetøj

SBS/PP, kann bei der Zahnreinigung unterstützen, besonders robust, verstärkte Schicht im Kern | *SBS/PP, can help to clean teeth, extremely robust, reinforced layer in the core* | SBS/PP, peut aider à nettoyer les dents, particulièrement robuste, couche renforcée dans le noyau | *SBS/PP, complementa la limpieza dental, especialmente resistente, capa reforzada en el centro* | SBS/PP, può aiutare nella pulizia bucale, particolarmente robusto, strato rinforzato nel cuore | *SBS/PP, kann understøtte tandrensning, særlig robust, forstærket lag i kernen*

6,5 cm 69300  7,5 cm 201377 

Hundenspielzeug KONG® SQUEEZZ® GOOMZ

Dog toy | Jouet pour chiens | Juguete para perros | Giocattolo per cani | Hundelegetøj

TPE, mit Squeaker, mit erhöhten Noppen, kann bei der Zahnreinigung unterstützen, besonders robust | *TPE, with squeaker, with raised nubs, can help to clean teeth, extremely robust* | TPE, avec couineur, avec des picots en relief, peut aider à nettoyer les dents, particulièrement robuste | *TPE, con sonajero, con pomos elevados, complementa la limpieza dental, especialmente resistente* | TPE, con manopole sollevate, con squeaker, può aiutare nella pulizia bucale, particolarmente robusto | *TPE, med squeaker, med løftede knopper, kann understøtte tandrensning, særlig robust*

6,5 cm 69302  9 cm 69303 

Hundenspielzeug KONG® DURAMAX™ BALL

Dog toy | Jouet pour chiens | Juguete para perros | Giocattolo per cani | Hundelegetøj

TPE, mit Squeaker, kann bei der Zahnreinigung unterstützen, besonders robust, für Hunde, die vom Kauen nicht genug bekommen können | *TPE, with squeaker, can help to clean teeth, extremely robust, dogs that can't spend enough time chewing* | TPE, avec couineur, peut aider à nettoyer les dents, particulièrement robuste, pour les chiens qui n'en ont jamais assez de mâcher | *TPE, con sonajero, complementa la limpieza dental, especialmente resistente, para perros que no se cansan de masticar* | TPE, con squeaker, può aiutare nella pulizia bucale, particolarmente robusto, per i cani che non ne hanno mai abbastanza di masticare | *TPE, med squeaker, kann understøtte tandrensning, særlig robust, til hunde, der ikke kan få nok af at tygge*

6,5 cm 69301 



33 cm
Gesamtlänge
total length



assorted colours

III
4 Stck. | pcs.



assorted colours

III
3 Stck. | pcs.



assorted colours

III
4 Stck. | pcs.

Hundenspielzeug KONG® JAXX BRIGHTS BALL

Dog toy | Jouet pour chiens | Juguete para perros | Giocattolo per cani | Hundelegetøj

TPR/Polyester, mit Tau, besonders robust, kann bei der Zahnreinigung unterstützen, farblich sortiert | *TPR/Polyester, with rope, especially robust, can help to clean teeth, assorted colours* | TPR/Polyester, avec corde, particulièrement robuste, peut aider à nettoyer les dents, couleurs assorties | *TPR/Poliéster, con cuerda, especialmente robusto, complementa la limpieza dental, colores surtidos, colores surtidos* | TPR/Poliestere, con corda, particolarmente robusto, può aiutare nella pulizia bucale, colori assortiti | *TPR/Polyester, med reb, særlig robust, kan understøtte tandrensning, farvemæssigt sorteret*

Ball | Ball | Balle | Balón | Palla | Bold

8 cm 69719

Hundenspielzeug KONG® FLYANGLE™

Dog toy | Jouet pour chiens | Juguete para perros | Giocattolo per cani | Hundelegetøj

TPR, schwimmfähig, besonders robust, durch die besondere Form gut für Zerspiele geeignet, farblich sortiert | *TPR, floatable, particularly robust, due to the special shape especially suitable for tugging games, assorted colours* | TPR, flottant, particulièrement robuste, convient particulièrement aux jeux de trituration grâce à sa forme particulière, couleurs assorties | *TPR, flotante, particularmente robusto, gracias a su forma especial, especialmente adecuado para juegos de tirones, colores surtidos* | TPR, galleggiate, particolarmente robusto, grazie alla forma speciale è particolarmente adatto per i giochi di trazione, colori assortiti | *TPR, flydende, særligt robust, på grund af den særlige form særligt velegnet til trækkelege, farvemæssigt sorteret*

27 cm 201352

Hundenspielzeug KONG® OGEE™ STICK

Dog toy | Jouet pour chiens | Juguete para perros | Giocattolo per cani | Hundelegetøj

TPR, flexibel und biegsam, schwimmfähig, beugt Verletzungen beim Spielen vor, für Wurf- und Zerspiele bestens geeignet, farblich sortiert | *TPR, flexible and bendable, buoyant, prevents injuries during play, ideally suited for throwing and tugging games, assorted colours* | TPR, flexible et souple, flottant, prévient les blessures pendant le jeu, convient parfaitement aux jeux de lancer et de déchirer, couleurs assorties | *TPR, flexible y flexible, flotante, evita lesiones durante el juego, ideal para juegos de lanzar y tirar, colores surtidos* | TPR, flessibile e pieghevole, galleggiate, previene le lesioni durante il gioco, ideale per i giochi di lancio e stratonamento, colori assortiti | *TPR, fleksibel og bøjelig, flyder, forebygger skader under leg, ideel til kaste- og trækkelege, farvemæssigt sorteret*

30 cm 201349

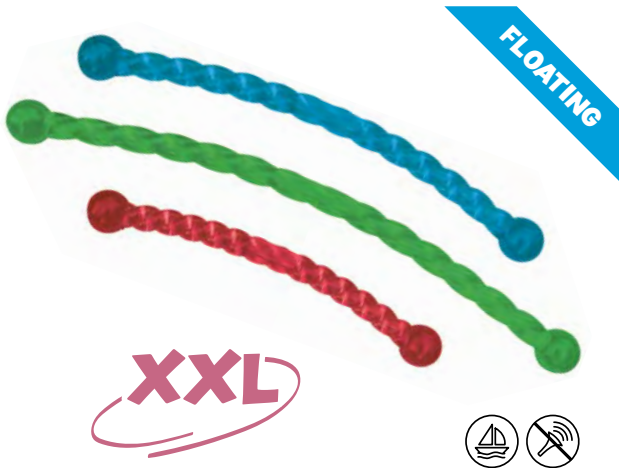

Hundenspielzeug KONG® SAFESTIX

Dog toy | Jouet pour chiens | Juguete para perros | Giocattolo per cani | Hundelegetøj

TPR, flexibel und biegsam, schwimmfähig, beugt Verletzungen beim Spielen vor, für Wurf- und Zerrspiele bestens geeignet, farblich sortiert | *TPR, flexible and bendy, floating, prevents injury during play, ideally suited for throwing and tugging games, assorted colours* | TPR, flexible et élastique, nageant, évite les blessures lors du jeu, parfaitement adapté aux jeux de lancer et de traction, couleurs assorties | *TPR, flexible y plegable, flotante, evita lesiones durante el juego, ideal para juegos de lanzamiento y tirones, colores surtidos* | TPR, flessibile e pieghevole, galleggiante, evita lesioni durante il gioco, adatto per lanciare e come tira-molla, colori assortiti | *TPR, fleksibel og bøjelig, svømmende, forebygger mod skader ved leg, allebedst egnet til kaste- og ruskelege, farvemæssigt sorteret*

assorted colours

III

3 Stck. | pcs.

30 cm 61101  50 cm 61102 

70 cm 61103 



Hundenspielzeug KONG® TRAINING DUMMY

Dog toy | Jouet pour chiens | Juguete para perros | Giocattolo per cani | Hundelegetøj

EVA/Polyester, mit Tau, schwimmfähig | *EVA/Polyester, with rope, floating* | EVA/Polyester, avec corde, nageant | *EVA/Poliéster, con cuerda, flotante* | EVA/Poliestere, con corda, galleggiante | *EVA/Polyester, med tov, svømmende*

27 cm 62659 

III

3 Stck. | pcs.



Hundenspielzeug KONG® SQUEEZZ® CRACKLE

Dog toy | Jouet pour chiens | Juguete para perros | Giocattolo per cani | Hundelegetøj

TPR, mit Knistergeräuschen, farblich sortiert | *TPR, with crackling sounds, assorted colours* | TPR, avec bruits de crépitement, couleurs assorties | *TPR, con sonidos crepitantes, colores surtidos* | TPR, con suoni scoppiettanti, colori assortiti | *TPR, med knitrende lyde, farvemæssigt sorteret*

1: Knochen | Bone | Os | Hueso | Osso | Knogle

15 cm 201375 

2: Stick

30 cm 201376 

assorted colours

III

4 Stck. | pcs.



assorted colours

III
4 Stck. | pcs.

Hundespielzeug KONG® SQUEEZZ® STICK

Dog toy | Jouet pour chiens | Juguete para perros | Giocattolo per cani | Hundelegetøj

TPR, mit Squeaker, farblich sortiert | *TPR, with squeaker, assorted colours* | TPR, avec squeaker, couleurs assorties | *TPR, con chirriador, colores surtidos* | TPR, con squeaker, colori assortiti | *TPR, med piver, farvemæssigt sorteret*

18 cm 201379 



DENTAL

III
3 Stck. | pcs.

Hundespielzeug KONG® SQUEEZZ® DENTAL STICK

Dog toy | Jouet pour chiens | Juguete para perros | Giocattolo per cani | Hundelegetøj

TPR, befüllbar mit Snacks, kann die Zahnreinigung unterstützen | *TPR, fillable with snacks, can help clean teeth* | TPR, peut être rempli de friandises, peut aider au nettoyage des dents | *TPR, rellenable con snacks, puede ayudar a limpiar los dientes* | TPR, riempibile con snack, può aiutare a pulire i denti | *TPR, der kan fyldes med snacks, kan hjælpe med at rense tænderne*

20 cm 201366 



assorted colours

III
3 Stck. | pcs.

Hundespielzeug KONG® TREAT SPIRAL STICK

Dog toy | Jouet pour chiens | Juguete para perros | Giocattolo per cani | Hundelegetøj

TPR, befüllbar mit Snacks, besonders robust, farblich sortiert | *TPR, can be filled with snacks, especially robust, assorted colours* | TPR, peut être rempli de snacks, particulièrement résistant, couleurs assorties | *TPR, se puede rellenar con aperitivos, especialmente resistente, colores surtidos* | TPR, riempibile con snack, particolarmente robusto, colori assortiti | *TPR, kan fyldes med snacks, særligt robust, farvemæssigt sorteret*

23,5 cm 201367 



III
3 Stck. | pcs.

Hundespielzeug KONG® CORESTRENGTH™ BAMBOO BONE

Dog toy | Jouet pour chiens | Juguete para perros | Giocattolo per cani | Hundelegetøj

TPR/Bambus, kann bei der Zahnreinigung unterstützen, besonders robust, verstärkte Schicht im Kern | *TPR/Bamboo, can help clean teeth, especially robust, reinforced layer in the core* | TPR/bambou, peut aider au nettoyage des dents, particulièrement robuste, couche renforcée dans le noyau | *TPR/Bambú, puede ayudar a limpiar los dientes, especialmente robusto, capa reforzada en el núcleo* | TPR/Bamboo, può aiutare a pulire i denti, particolarmente robusto, strato rinforzato nel nucleo centrale | *TPR/Bambus, kan hjælpe med at rense tænderne, særligt robust, forsterket lag i kernen*

16 cm 201345



III
3 Stck. | pcs.

Hundespielzeug KONG® DOTZ™ CIRCLE

Dog toy | Jouet pour chiens | Juguete para perros | Giocattolo per cani | Hundelegetøj

TPR/TPE, mit Squeaker, besonders robust, kann bei der Zahnreinigung unterstützen | *TPR/TPE, with squeaker, particularly robust, can help clean teeth* | TPR/TPE, avec squeaker, particulièrement robuste, peut aider au nettoyage des dents | *TPR/TPE, con chirriador, especialmente robusto, puede ayudar a limpiar los dientes* | TPR/TPE, con squeaker, particolarmente robusto, può aiutare a pulire i denti | *TPR/TPE, med squeaker, særligt robust, kan hjælpe med at rense tænderne*

14,5 cm 201368



assorted colours
III
4 Stck. | pcs.

Hundespielzeug KONG® QUEST STAR PODS

Dog toy | Jouet pour chiens | Juguete para perros | Giocattolo per cani | Hundelegetøj

TPR, befüllbar mit Snacks, farblich sortiert | *TPR, can be filled with snacks, assorted colours* | TPR, à remplir de friandises, couleurs assorties | *TPR, se puede rellenar con comida, colores surtidos* | TPR, si può riempire con snack, colori assortiti | *TPR, kan fyldes med godbidder, farvemæssigt sorteret*

11 cm 65012



Hundenspielzeug KONG® GYRO

Dog toy | Jouet pour chiens | Juguete para perros | Giocattolo per cani | Hundelegetøj

TPR/Kunststoff, befüllbar mit Snacks, verteilt Futter und Snacks durch Roll- und Kippbewegung | TPR/Plastic, can be filled with snacks, rolling and tipping motions dispense food and treats | TPR/Plastique, à remplir de friandises, distribue de la nourriture et des friandises en roulant et en se retournant | TPR/Plástico, se puede rellenar con comida, reparte pienso y snacks al moverlo y hacerlo rodar | TPR/Plástico, si può riempire con snack, distribuisce cibo e snack attraverso un movimento rotatorio e oscillatorio | TPR/Kunststof, kan fyldes med godbidder, fordele foder og snacks med rulle-og vippe-bevegelser

13 cm 66421  17 cm 66422 

III
2 Stck. | pcs.



Hundenspielzeug KONG® REWARDS

Dog toy | Jouet pour chiens | Juguete para perros | Giocattolo per cani | Hundelegetøj

TPR, befüllbar mit Snacks, für leises Spiel entwickelt, besonders robust | TPR, can be filled with snacks, specially designed for quiet play, particularly robust | TPR, à remplir de friandises, conçu pour un jeu silencieux, particulièrement robuste | TPR, se puede rellenar con comida, diseñado especialmente para juegos poco ruidosos, muy resistente | TPR, si può riempire con snack, creato per il gioco tranquillo, particolarmente robusto | TPR, kan fyldes med godbidder, designet til stille spil, især robust

1: Muschel | Shell | Coquillage | Concha | Conchiglia | Shell

10 cm 67378 

2: Ball | Ball | Balle | Balón | Palla | Bold

13 cm 67379 

III
4 Stck. | pcs.



IIII
2 Stck. | pcs.

Hundespielzeug KONG® REWARDS TENNIS

Dog toy | Jouet pour chiens | Juguete para perros | Giocattolo per cani | Hundelegetøj

TPR, befüllbar mit Snacks, kann das Herunterschlingen von Futter verhindern, besonders robust | *TPR, can be filled with snacks, can prevent the lining from snarling down, extremely robust* | TPR, à remplir de friandises, peut empêcher la consommation d'aliments, particulièrement robuste | *TPR, se puede rellenar con comida, puede evitar que se coman los alimentos, especialmente resistente* | TPR, si può riempire con snack, può impedire che il cibo venga mangiato, particolarmente robusto | *TPR, kan fyldes med godbidder, kan forhindre mad i at blive slugt, særlig robust*

8 cm 68848 14 cm 68849

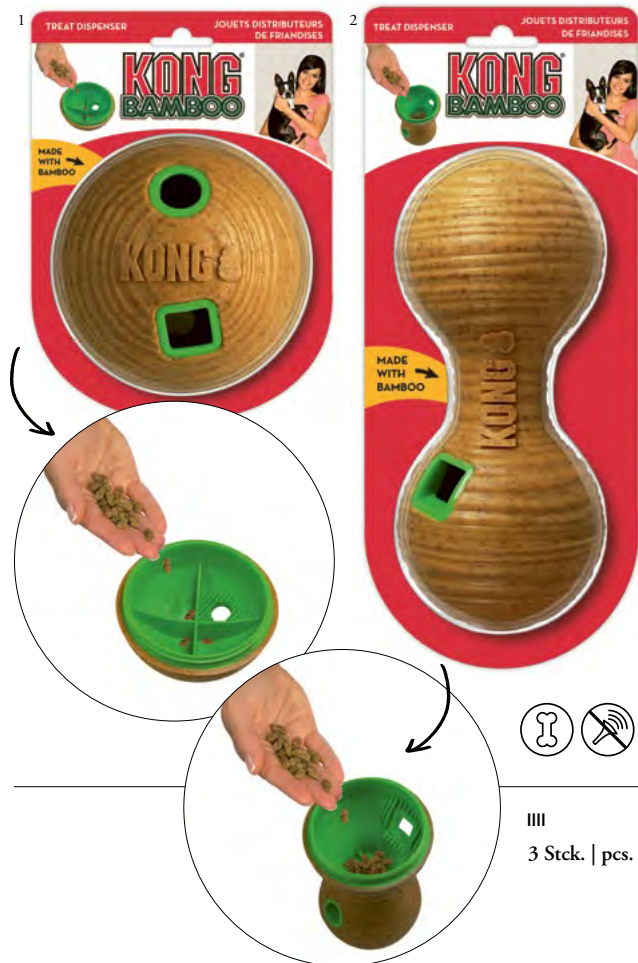

IIII
3 Stck. | pcs.

Hundespielzeug KONG® BAMBOO FEEDER

Dog toy | Jouet pour chiens | Juguete para perros | Giocattolo per cani | Hundelegetøj

PP/TPR/Bambus, befüllbar mit Snacks, für leises Spiel entwickelt, besonders robust | *PP/TPR/Bamboo, can be filled with snacks, specially designed for quiet play, particularly robust* | PP/TPR/Bambou, à remplir de friandises, conçu pour un jeu silencieux, particulièrement robuste | *PP/TPR/Bambú, se puede rellenar con comida, diseñado especialmente para juegos poco ruidosos, muy resistente* | PP/TPR/Bambù, si può riempire con snack, creato per il gioco tranquillo, particolarmente robusto | *PP/TPR/Bambus, kan fyldes med godbidder, designet til stille spil, især robust*

1: Ball | Ball | Balle | Balón | Palla | Bold

12 cm 68850

2: Hantel | Dumbbell | Haltère | Mancuerna | Manubrio | Håndvægt

20 cm 68851



Hundenspielzeug KONG® REWARDS WALLY®

Dog toy | Jouet pour chiens | Juguete para perros | Giocattolo per cani | Hundelegetøj

PP, befüllbar mit Futter und Snacks, unterstützt eine langsame Nahrungsaufnahme, für leises Spiel entwickelt | PP, can be filled with food and snacks, supports slow food intake, designed for quiet play | PP, peut être rempli de nourriture et de collations, favorise une alimentation lente, conçu pour un jeu tranquille | PP, puede ser llenado con comida y bocadillos, apoya la ingesta lenta de alimentos, diseñado para el juego tranquilo | PP, può essere riempito con cibo e snack, supporta l'assunzione di cibo lento, progettato per un gioco tranquillo | PP, kan fyldes med mad og snacks, understøtter langsom madindtagelse, udviklet til stille spil

13 cm 69655 

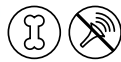

KONG® Tikr

Der KONG® Tikr funktioniert wie ein Kurzzeitwecker – einfach, zuverlässig und ganz ohne Batterien. Das innovative Snackspielzeug von KONG® kann über eine Dauer von bis zu 45 Minuten Snacks oder Trockenfutter abgeben. Keine Batterien notwendig.

The KONG® Tikr works like a short-time alarm clock - simple, reliable and completely without batteries. The innovative snack toy from KONG® can deliver snacks or dry food for up to 45 minutes. No batteries needed.



Hundenspielzeug KONG® TIKR

Dog toy | Jouet pour chiens | Juguete para perros | Giocattolo per cani | Hundelegetøj

PP/TPR, befüllbar mit Futter und Snacks (auch unterschiedlicher Größen), mit Timer (bis 45 Minuten einstellbar) für zeitgesteuerte Leckerchenabgabe, keine Batterien erforderlich | PP/TPR, can be filled with food and snacks (also of different sizes), with timer (adjustable up to 45 minutes) for timed treat release, no batteries needed | PP/TPR, peut être rempli d'aliments et de friandises (également de tailles différentes), avec minuterie (réglable jusqu'à 45 minutes) pour une distribution programmée de friandises, pas de piles nécessaires | PP/TPR, se puede rellenar con comida y snacks (también de diferentes tamaños), con temporizador (ajustable hasta 45 minutos) para la liberación de golosinas temporizada, no necesita pilas | PP/TPR, può essere riempito con cibo e snack (anche di diverse dimensioni), con timer (regolabile fino a 45 minuti) per il rilascio temporizzato del bocconcino, senza bisogno di batterie | PP/TPR, kan fyldes med mad og snacks (også i forskellige størrelser), med timer (justerbar op til 45 minutter) til tidsbestemt frigivelse af godbidder, ingen batterier nødvendige

S 69657  L 69658 

↗	■	
S	10 x 12 cm	2 Stck. pcs.
L	12 x 17 cm	2 Stck. pcs.



15 cm
15 cm auch für Katzen geeignet
 15 cm also suitable for cats



20 cm



III
 3 Stck. | pcs.

Leckerchen-Spender KONG® LICKS SPINZ

Treat dispenser | Distributeur de friandises | Dispensador de golosinas | Dispenser di trattamenti | Dispenser til godbidder

Polypropylen, befüllbar mit Snacks, doppelseitige Leckmatte mit verschiedenen Strukturen für mehr Abwechslung, Drehscheibe fördert Interaktion, abnehmbare Scheibe für einfache Reinigung, rutschfeste Basis für mehr Stabilität, kann Zahngesundheit und frischen Atem fördern | *Polypropylene, can be filled with snacks, double-sided lick mat with different structures for more variety, rotating disc promotes interaction, removable disc for easy cleaning, non-slip base for more stability, can promote dental health and fresh breath* | *Polypropylène, peut être rempli de friandises, tapis à lécher double face avec différentes structures pour plus de variété, le disque rotatif favorise l'interaction, disque amovible pour un nettoyage facile, base antidérapante pour plus de stabilité, peut favoriser la santé dentaire et une haleine fraîche* | *Polipropileno, puede rellenarse con snacks, alfombrilla para lamer de doble cara con diferentes estructuras para mayor variedad, el disco giratorio fomenta la interacción, disco extraíble para facilitar la limpieza, base antideslizante para mayor estabilidad, puede fomentar la salud dental y un aliento fresco* | *Polipropilene, può essere riempito di snack, tappetino da leccarsi su due lati con strutture diverse per una maggiore varietà, il disco rotante favorisce l'interazione, il disco è rimovibile per una facile pulizia, la base antiscivolo garantisce una maggiore stabilità, può favorire la salute dei denti e l'alito fresco* | *Polypropylen, kan fylles med snacks, dobbeltsidet slikkematte med forskellige strukturer for mere variation, roterende skive fremmer interaktion, aftagelig skive for nem rengøring, skridsikker base for mere stabilitet, kan fremme tandsundhed og frisk ånde*

15 cm 207580  20 cm 207574 

Double-Sided
 Spinning Disc
 Disque rotatif
 à double face
 Doppelseitige
 Drehscheibe
 Disco rotante
 su due lati

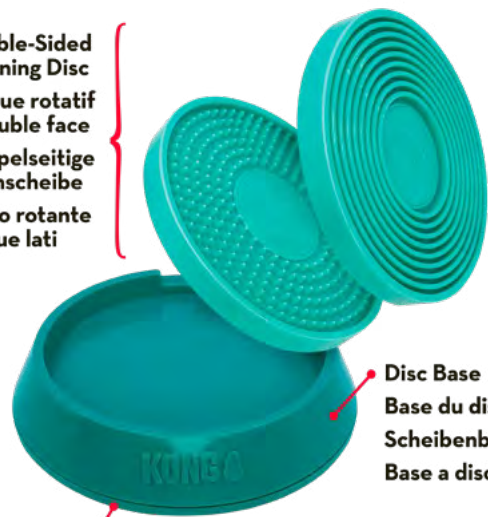

Non-skid Base • Base antidérapante
 Rutschfeste Basis • Base antiscivolo



DENTAL

Leckerchen-Spender KONG® LICKS REWARDS

Treat dispenser | Distributeur de friandises | Dispensador de golosinas | Dispenser di trattamenti | Dispenser til godbidder

TPR, befüllbar mit Snacks, durch die beschwerte Basis richtet sich das Spielzeug immer wieder auf, animiert zum Lecken, einfach von Hand zu reinigen, kann Zahngesundheit und frischen Atem fördern | *TPR, can be filled with snacks, the weighted base keeps the toy upright, encourages licking, easy to clean by hand, can promote dental health and fresh breath* | TPR, peut être rempli de friandises, grâce à la base lestée, le jouet se redresse toujours, incite à lécher, facile à nettoyer à la main, peut favoriser la santé dentaire et une haleine fraîche | *TPR, se puede rellenar con snacks, la base con peso mantiene el juguete en posición vertical, anima a lamer, fácil de limpiar a mano, puede promover la salud dental y un aliento fresco* | TPR, può essere riempito di snack, la base appesantita mantiene il giocattolo in posizione verticale, incoraggia il leccamento, facile da pulire a mano, può promuovere la salute dei denti e l'alito fresco | *TPR, kan fyldes med snacks, den vægtede base holder legetøjet oprejst, opfordrer til at slikke, let at rengøre i hånden, kan fremme tandsundhed og frisk ånde*



15 cm 207577 

Durch die beschwerte Basis richtet sich das Spielzeug immer wieder auf
the weighted base keeps the toy upright



III
3 Stck. | pcs.



Mit 6 Öffnungen für Snacks
6 treat openings



IIII
2 Stck. | pcs.

Hundenspielzeug KONG® REWARDS TINKER

Dog toy | Jouet pour chiens | Juguete para perros | Giocattolo per cani | Hundelegetøj

PP/TPR, befüllbar mit Snacks, verteilt Futter und Snacks durch Roll- und Kippbewegung, Trichter ermöglicht einfaches Befüllen | PP/TPR, can be filled with snacks, distributes food and snacks by rolling and tilting movement, funnel allows easy filling | PP/TPR, peut être rempli de snacks, distribue la nourriture et les snacks par un mouvement de roulement et de basculement, l'entonnoir permet un remplissage facile | PP/TPR, puede rellenarse con aperitivos, distribuye los alimentos y aperitivos mediante movimiento de balanceo e inclinación, el embudo permite un fácil llenado | PP/TPR, può essere riempito di snack, distribuisce cibo e snack con movimenti di rotazione e inclinazione, l'imbuto permette un facile riempimento | PP/TPR, kan fylles med snacks, fordele mad og snacks ved at rulle og vippe, tragt gør påfyldning nem

14,5 cm 201351 



Frei bewegliches Gewinde im Inneren sorgt für langsame Abgabe des Futters
Internal spinner slows kibble flow



Hundenspielzeug KONG® TREAT SPINNER

Dog toy | Jouet pour chiens | Juguete para perros | Giocattolo per cani | Hundelegetøj

PP/TPR, befüllbar mit Futter und Snacks, unterstützt eine langsame Nahrungsaufnahme, für leises Spiel entwickelt | PP/TPR, can be filled with food and snacks, supports slow food intake, designed for quiet play | PP/TPR, peut être rempli de nourriture et de collations, favorise une alimentation lente, conçu pour un jeu tranquille | PP/TPR, puede ser llenado con comida y bocadillos, apoya la ingesta lenta de alimentos, diseñado para el juego tranquilo | PP/TPR, può essere riempito con cibo e snack, supporta l'assunzione di cibo lento, progettato per un gioco tranquillo | PP/TPR, kan fylles med mad og snacks, understøtter langsom madindtagelse, udviklet til stille spil

17 cm 68854 





Welpenrezeptur
Puppy recipe

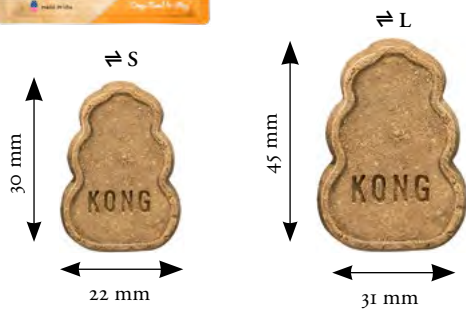

↗	📦
S	198 g
L	312 g

Hundesnack KONG® SNACKS™

Reward | Récompense | Recompensa | Snack per cani | Hundesnack

Diese schmackhaften Leckerbissen passen durch ihre spezielle Form und Größe perfekt in das KONG®-Hundespielzeug, hergestellt aus hochwertigen und natürlich guten Zutaten | *These tantalizing treats are specially shaped and sized to fit the dog's KONG® toy, made from high-quality and naturally good ingredients* | Ces friandises appétissantes peuvent être dimensionnées spécialement pour entrer dans le jouet KONG® du chien, fabriqués à partir d'ingrédients de haute qualité et naturellement bons | *Este manjar tiene la forma y el tamaño adecuados para el juguete KONG® para perros, hecho de ingredientes de alta calidad y naturalmente buenos* | Gustosissimo snack, la loro forma particolare ne fa il ripieno ideale per il giocattolo KONG®, fatto con ingredienti di alta qualità e naturalmente buoni | *Spændende guf, er dog formet således, at det i størrelsen passer nøjagtigt til KONG®-legetøj, lavet af høj kvalitet og naturligt gode ingredienser*

mit echter Hühnerleber und Heidelbeeren | with real chicken liver and blueberries | avec du vrai foie de poulet et des myrtilles | con auténtico hígado de pollo y arándanos | con vero fegato di pollo e mirtilli | med ægte kyllingelever og blåbær

S 47755 L 47756

mit echtem Lachs und Heidelbeeren | with real salmon and blueberries | avec du vrai saumon et des myrtilles | con salmón real y arándanos | con vero salmone e mirtilli | med ægte laks og blåbær

S 47757 L 47758

mit echtem Speckgeschmack | with real bacon flavour | avec un vrai goût de bacon | con auténtico sabor a bacon | con vero sapore di pancetta | med smag af ægte bacon

S 68844



Paste KONG® STUFF'N™ PEANUT BUTTER

Paste | Pâtée | Pastas | Pasta | Paste

Zutaten: Erdnüsse/Palmöl/Leinsamen, praktischer Beutel und saubere Düse für einfaches Befüllen | *Ingredients: Peanuts/palm oil/flaxseed, practical bag and clean nozzle for easy filling* | Ingrédients : cacahuètes/huile de palme/graines de lin, sachet pratique et buse propre pour un remplissage facile | *Ingredientes: Cacahuètes/aceite de palma/linaza, práctica bolsa y boquilla limpia para facilitar el llenado* | Ingredienti: Semi di arachidi/olio di palma/semi di lino, pratico sacchetto e beccuccio pulito per un facile riempimento | *Ingredienser: Jordnødder/palmolie/linsefrø, praktisk pose og ren dyse til nem påfyldning*

170 g 201342 



Welpenrezeptur
Puppy recipe



Paste KONG® EASY TREAT™

Paste | Pâtée | Pastas | Pasta | Paste

praktische Sprühdose | *practical spray can* | aérosol pratique | *práctico dosificador* | pratica lattina spray | *praktisk spraydåse*

für Welpen | for puppies | pour les chiots | para los cachorros | per i cuccioli | til hvalpe

226 g 42502 

mit Leber | with liver | avec le foie | con el hígado | con il fegato | med lever

226g 42503 

mit Käse

226g 68843 



⇒	∅	III
XS	4,5 cm	3 x 3 Stck. pcs.
S	5,0 cm	3 x 3 Stck. pcs.
M/1x	6,0 cm	24 x 1 Stck. pcs.
M/3x	6,0 cm	3 x 3 Stck. pcs.
M/6x	6,0 cm	2 x 6 Stck. pcs.
L/VE3	8,0 cm	3 x 2 Stck. pcs.
L/VE24	8,0 cm	24 x 2 Stck. pcs.
XL	10,0 cm	3 x 1 Stck. pcs.

Hundenspielzeug KONG® SQUEAKAIR® BALLS

Dog toy | Jouet pour chiens | Juguete para perros | Giocattolo per cani | Hundelegetoj

Gummi/Polyester, zahnfreundlich, mit Squeaker | Rubber/Polyester, gentle on teeth, with squeaker | Caoutchouc/Polyester, n'abime pas les dents, avec couineur | De goma/Poliéster, respetuoso con los dientes, con sonido | Gomma piena/Poliestere, preserva i denti, con squeaker | Massivt gummi/Polyester, tandvenlig, med squeaker

gelb | yellow | jaune | amarillo | giallo | gul

XS	47696	S	62000
M/1x	68869	M/3x	42505
M/6x	67384	L/VE3	62018
L/VE24	201380	XL	68870



51 cm
Gesamtlänge
total length

III
3 Stck. | pcs.

Hundenspielzeug KONG® SQUEAKAIR® BALL WITH ROPE

Dog toy | Jouet pour chiens | Juguete para perros | Giocattolo per cani | Hundelegetoj

Gummi/Polyester, zahnfreundlich, mit Tau, mit Squeaker | Rubber/Polyester, gentle on teeth, with rope, with squeaker | Caoutchouc/Polyester, n'abime pas les dents, avec corde, avec couineur | De goma/Poliéster, respetuoso con los dientes, con cuerda, con sonido | Gomma piena/Poliestere, preserva i denti, con corda, con squeaker | Massivt gummi/Polyester, tandvenlig, med tov, med squeaker

gelb | yellow | jaune | amarillo | giallo | gul

6 cm 66417



III
3 Stck. | pcs.

Hundenspielzeug KONG® AIRDOG® SQUEAKER FOOTBALL

Dog toy | Jouet pour chiens | Juguete para perros | Giocattolo per cani | Hundelegetoj

Gummi/Polyester, zahnfreundlich, mit Squeaker | Rubber/Polyester, gentle on teeth, with squeaker | Caoutchouc/Polyester, n'abime pas les dents, avec couineur | De goma/Poliéster, respetuoso con los dientes, con sonido | Gomma piena/Poliestere, preserva i denti, con squeaker | Massivt gummi/Polyester, tandvenlig, med squeaker

gelb | yellow | jaune | amarillo | giallo | gul

8 cm 65033 13 cm 65008
16,5 cm 65006



III
3 Stck. | pcs.

Hundespielzeug KONG® AIRDOG® SQUEAKER BONE

Dog toy | Jouet pour chiens | Juguete para perros | Giocattolo per cani | Hundelegetøj

Gummi/Polyester, zahnfreundlich, mit Squeaker | *Rubber/Polyester, easy on the teeth, with squeaker* | Caoutchouc/Polyester, n'abime pas les dents, avec couineur | *De goma/Poliéster, respetuoso con los dientes, con sonido* | Gomma piena/Poliestere, preserva i denti, con squeaker | *Massivt gummi/Polyester, tandvenlig, med squeaker*

gelb | yellow | jaune | amarillo | giallo | gul

11 cm 65019  16 cm 65024 

23,5 cm 65013 

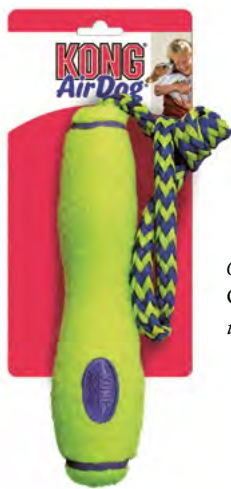

FLOATING

66 cm / 81 cm
Gesamtlänge
total length





III
3 Stck. | pcs.

Hundespielzeug KONG® AIRDOG® SQUEAKER FETCH STICK WITH ROPE

Dog toy | Jouet pour chiens | Juguete para perros | Giocattolo per cani | Hundelegetøj

Gummi/Polyester, zahnfreundlich, mit Tau, schwimmfähig | *Rubber/Polyester, gentle on teeth, with rope, floating* | Caoutchouc/Polyester, n'abime pas les dents, avec corde, nageant | *De goma/Poliéster, respetuoso con los dientes, con cuerda, flotante* | Gomma piena/Poliestere, preserva i denti, con corda, con galleggiante | *Massivt gummi/Polyester, tandvenlig, med tov, svømmende*

gelb | yellow | jaune | amarillo | giallo | gul

13 cm 42507  28 cm 42508 



III
3 Stck. | pcs.

Hundespielzeug KONG® AIRDOG® SQUEAKER DUMBBELL

Dog toy | Jouet pour chiens | Juguete para perros | Giocattolo per cani | Hundelegetøj

Gummi/Polyester, zahnfreundlich, mit Squeaker | *Rubber/Polyester, gentle on teeth, with squeaker* | Caoutchouc/Polyester, n'abime pas les dents, avec couineur | *De goma/Poliéster, respetuoso con los dientes, con sonido* | Gomma piena/Poliestere, preserva i denti, con squeaker | *Massivt gummi/Polyester, tandvenlig, med squeaker*

gelb | yellow | jaune | amarillo | giallo | gul

14 cm 65034  18 cm 62648 



III
3 Stck. | pcs.

Hundespielzeug KONG® AIRDOG® SQUEAKER KNOBBY BALL

Dog toy | Jouet pour chiens | Juguete para perros | Giocattolo per cani | Hundelegetoj

Gummi/Polyester, zahnfreundlich, mit Squeaker | *Rubber/Polyester, gentle on teeth, with squeaker* | Caoutchouc/Polyester, n'abîme pas les dents, avec couineur | *De goma/Poliéster, respetuoso con los dientes, con sonido* | Gomma piena/Poliestere, preserva i denti, con squeaker | *Massiivt gummi/Polyester, tandvenlig, med squeaker*

5 cm 201346  9,5 cm 69536 



III
3 Stck. | pcs.

Hundespielzeug KONG® AIRDOG® SQUEAKER PAW

Dog toy | Jouet pour chiens | Juguete para perros | Giocattolo per cani | Hundelegetoj

Gummi/Polyester, zahnfreundlich, mit Squeaker | *Rubber/Polyester, easy on the teeth, with squeaker* | Caoutchouc/Polyester, n'abîme pas les dents avec couineur | *De goma/Poliéster, respetuoso con los dientes, con sonido* | Gomma piena/Poliestere, preserva I denti, con squeaker | *Massiivt gummi/Polyester, tandvenlig, med squeaker*

10,5 cm 201369 



III
3 x 3 Stck. | pcs.



↗	∅	III
XS	4,5 cm	3 x 3 Stck. pcs.
S	5,0 cm	3 x 3 Stck. pcs.
M	6,5 cm	3 x 3 Stck. pcs.
L	8,0 cm	3 x 2 Stck. pcs.

Hundespielzeug KONG® SQUEAKAIR® BIRTHDAY BALLS

Dog toy | Jouet pour chiens | Juguete para perros | Giocattolo per cani | Hundelegetøj

Gummi/Polyester, besonders robust, zahnfreundlich, mit Squeaker | Rubber/Polyester, extremely robust, gentle on teeth, with squeaker | Caoutchouc/Polyester, particulièrement robuste, n'abîme pas les dents, avec couineur | De goma/Poliéster, especialmente resistente, respetuoso con los dientes, con sonido | Gomma piena/Poliestere, particolarmente robusto, preserva i denti, con squeaker | Massivt gummi/Polyester, særlig robust, tandvenlig, med squeaker

6,5 cm 69294 

Hundespielzeug KONG® SIGNATURE SPORT BALLS

Dog toy | Jouet pour chiens | Juguete para perros | Giocattolo per cani | Hundelegetøj

Gummi/Polyester, besonders robust, zahnfreundlich | Rubber/Polyester, particularly robust, tooth-friendly | Caoutchouc/Polyester, particulièrement robuste, ne fait pas mal aux dents | De goma/Poliéster, especialmente resistente, respetuoso con los dientes | Gomma piena/Poliestere, particolarmente robusto, rispettoso dei denti | Massivt gummi/Polyester, særlig robust, tandvenlig

XS 69705  S 69706 
M 69707  L 69708 





Hundespielzeug KONG® SQUEAKAIR® ULTRA BALLS

Dog toy | Jouet pour chiens | Juguete para perros | Giocattolo per cani | Hundelegetøj

Gummi/Polyester, besonders robust, mit Squeaker, zahnfreundlich | Rubber/Polyester, extremely robust, with squeaker, gentle on teeth | Caoutchouc/Polyester, particulièrement robuste, avec couineur, n'abîme pas les dents | De goma/Poliéster, especialmente resistente, con sonido, respetuoso con los dientes | Gomma piena/Poliestere, particolarmente robusto, con squeaker, preserva i denti | Massivt gummi/Polyester, særlig robust, med squeaker, tandvenlig

7 cm 66418 

III
3 x 3 Stck. | pcs.



Hundespielzeug KONG® SPORT BALLS

Dog toy | Jouet pour chiens | Juguete para perros | Giocattolo per cani | Hundelegetøj

Gummi/Polyester, besonders robust | Rubber/Polyester, extremely robust | Caoutchouc/Polyester, particulièrement robuste | De goma/Poliéster, especialmente resistente | Gomma piena/Poliestere, particolarmente robusto | Massivt gummi/Polyester, særlig robust

XS 65383  S 65382 
M 65381  L 65380 

⇒	Ø	III
XS	4 cm	3 x 3 Stck. pcs.
S	5 cm	3 x 3 Stck. pcs.
M	6 cm	3 x 3 Stck. pcs.
L	8 cm	3 x 2 Stck. pcs.



Hundespielzeug KONG® CRUNCHAIR™ BALLS

Dog toy | Jouet pour chiens | Juguete para perros | Giocattolo per cani | Hundelegetøj

Gummi/Polyester, zahnfreundlich, mit Squeaker, mit Knackgeräuschen | Rubber/Polyester, gentle on teeth, with squeaker, with crackling noises | Caoutchouc/Polyester, n'abîme pas les dents, avec couineur, avec pops | De goma/Poliéster, respetuoso con los dientes, con sonido, con los papás | Gomma piena/Poliestere, preserva i denti, con squeaker, con i pops | Massivt gummi/Polyester, tandvenlig, med squeaker, med knakkende lyde

6 cm 68877 

III
3 x 3 Stck. | pcs.



assorted colours

III

3 Stck. | pcs.

Hundespielzeug KONG® WUBBA™ CLASSIC

Dog toy | Jouet pour chiens | Juguete para perros | Giocattolo per cani | Hundelegetøj

Nylon, mit Squeaker, farblich sortiert | Nylon, with squeaker, assorted colours | Nylon, avec couineur, couleurs assorties | Nylon, con sonido, colores surtidos | Nylon, con squeaker, colori assortiti | Nylon, med squeaker, farvemæssigt sorteret

23 cm 43830  33 cm 43831 
43 cm 43856 



assorted colours

III

4 Stck. | pcs.

Hundespielzeug KONG® WUBBA™ PUPPY

Dog toy | Jouet pour chiens | Juguete para perros | Giocattolo per cani | Hundelegetøj

Nylon, mit Squeaker, farblich sortiert | Nylon, with squeaker, assorted colours | Nylon, avec couineur, couleurs assorties | Nylon, con sonido, colores surtidos | Nylon, con squeaker, colori assortiti | Nylon, med squeaker, farvemæssigt sorteret

22 cm 43832 



assorted colours

III

3 Stck. | pcs.

Hundespielzeug KONG® WUBBA™ WET

Dog toy | Jouet pour chiens | Juguete para perros | Giocattolo per cani | Hundelegetøj

Neopren, schwimmfähig, Set farblich sortiert: gelb, grün, orange | Neoprene, floating, packaging unit: yellow, green, orange | Neoprène, nageant, unité d'emballage: jaune, vert, orange | Neopreno, flotante, unidad de embalaje: amarillo, verde, naranja | Neoprene, galleggiante, unità di vendita: giallo, verde, arancione | Neopren, svømmende, emballeringsenhed: gul, grøn, orange

35,5 cm 44436 



assorted colours

||||
4 Stck. | pcs.

Hundespielzeug KONG® WUBBA™ FLOPPY EARS

Dog toy | Jouet pour chiens | Juguete para perros | Giocattolo per cani | Hundelegetøj

Gummi/Polyester; strapazierfähiges, verstärktes Nylonmaterial, zwei Bälle im Inneren: ein Tennisball im Oberteil und ein Squeaker im Unterteil, farblich sortiert | *Rubber/Polyester, durable, reinforced nylon material, two balls on the inside: a tennis ball in the upper part and a squeaker in the lower part, assorted colours* | Caoutchouc/Polyester, matériau nylon résistant et renforcé, deux balles à l'intérieur: une balle de tennis sur le dessus et un squeaker dans la partie inférieure, couleurs assorties | *De goma/Poliéster, material de nylon resistente y reforzado, dos bolas en el interior: una pelota de tenis en la parte superior y un pito en la parte inferior, colores surtidos* | Gomma piena/Poliestere, materiale in Nylon rafforzato, resistente, con all'interno due palline: una pallina da tennis nella parte superiore e una con squeak in quella inferiore, colori assortiti | *Massivt gummi/Polyester, slidsterket, forstærket nylonmateriale, to bolde i det indre: en tennisbold i overdelen og en squeaker i underdelen, farvemæssigt sorteret*

24 cm 62002 33 cm 62003



assorted colours

||||
3 Stck. | pcs.

Hundespielzeug KONG® SNUGGA WUBBA™

Dog toy | Jouet pour chiens | Juguete para perros | Giocattolo per cani | Hundelegetøj

Polyester/Nylon/Vinyl, farblich sortiert | *Polyester/Nylon/Vinyl, assorted colours* | Polyester/Nylon/Vinyl, couleurs assorties | *Poliéster/Nylon/Vinilo, colores surtidos* | Poliestere/Nylon/Vinile, colori assortiti | *Polyester/Nylon/Vinyl, farvemæssigt sorteret*

35,5 cm 44433



assorted colours

||||
3 Stck. | pcs.

Hundespielzeug KONG® WUBBA™ FRIENDS

Dog toy | Jouet pour chiens | Juguete para perros | Giocattolo per cani | Hundelegetøj

Plüsch, mit Squeaker, farblich sortiert | *Plush, with squeaker, assorted colours* | Peluche, avec couineur, couleurs assorties | *Felpa, con sonido, colores surtidos* | Peluche, con squeaker, colori assortiti | *Phys, med squeaker, farvemæssigt sorteret*

27 cm 46594 41 cm 46595

51 cm 46596



assorted colours

III
3 Stck. | pcs.

Hundespielzeug KONG® WUBBA™ WEAVES

Dog toy | Jouet pour chiens | Juguete para perros | Giocattolo per cani | Hundelegetøj

Polyester/Baumwolle, mit Squeaker, kann bei der Zahnreinigung unterstützen, farblich sortiert | *Polyester/Cotton, with squeaker, can help to clean teeth, assorted colours* | Polyester/Coton, avec couineur, peut aider à nettoyer les dents, couleurs assorties | *Poliéster/Algodón, con sonido, complementa la limpieza dental, colores surtidos* | Poliestere/Cotone, con squeaker, può aiutare nella pulizia bucale, colori assortiti | *Polyester/Bomuld, med squeaker, kan understøtte tandrensning, farvemæssigt sorteret*

21 cm 65410 33 cm 65409



assorted colours

III
4 Stck. | pcs.

Hundespielzeug KONG® WUBBA™ BALLISTIC FRIENDS

Dog toy | Jouet pour chiens | Juguete para perros | Giocattolo per cani | Hundelegetøj

Nylon, mit Squeaker, farblich sortiert | *Nylon, with squeaker, assorted colours* | Nylon, avec couineur, couleurs assorties | *Nylon, con sonido, colores surtidos* | Nylon, con squeaker, colori assortiti | *Nylon, med squeaker, farvemæssigt sorteret*

24 cm 47689 36 cm 47690
43 cm 47691



III
3 Stck. | pcs.

Hundespielzeug KONG® WUBBA™ FINZ

Dog toy | Jouet pour chiens | Juguete para perros | Giocattolo per cani | Hundelegetøj

Polyester, zwei innenliegende Bälle, mit Squeaker | *Polyester, two interior balls, with squeaker* | Polyester, avec deux balles à l'intérieur, avec couineur | *Poliéster, con dos pelotas interiores, con sonido* | Poliestere, due sfere interne, con squeaker | *Polyester, to bolde indeni, med squeaker*
rosa | light pink | rose clair | rosa pálido | rosa |

27 cm 68467

blau | blue | bleu | azul | blu | blå

37 cm 68465



assorted colours

III
3 Stck. | pcs.

Hundespielzeug KONG® WUBBA™ OCTOPUS

Dog toy | Jouet pour chiens | Juguete para perros | Giocattolo per cani | Hundelegetøj

Polyester, mit Squeaker, minimale Füllung, farblich sortiert | Polyester, with squeaker, minimal filling, assorted colours | Polyester, avec squeaker, remplissage minimal, couleurs assorties | Poliéster, con chirriador, relleno mínimo, colores surtidos | Poliester, con squeaker, imbottitura minima, colori assortiti | Polyester, med squeaker, minimalt fild, assorterede farver

22 cm 207613 32 cm 207610



assorted colours

III
3 Stck. | pcs.

Hundespielzeug KONG® BALLISTIC® VIBEZ BIRDS

Dog toy | Jouet pour chiens | Juguete para perros | Giocattolo per cani | Hundelegetøj

Polyester, besonders robust, mit Squeaker, farblich sortiert | Polyester, particularly robust, with squeaker, assorted colours | Polyester, particulièrement robuste, avec squeaker, couleurs assorties | Poliéster, especialmente robusto, con chirriador, colores surtidos | Poliester, particolarmente robusto, con squeaker, colori assortiti | Polyester, særligt robust, med pivtøj, farvemæssigt sorteret

32 cm 201339



III
3 Stck. | pcs.

Hundespielzeug KONG® PHATZ™ PIG

Dog toy | Jouet pour chiens | Juguete para perros | Giocattolo per cani | Hundelegetøj

Polyester, besonders robust, mit Squeaker | Polyester, extremely robust, with squeaker | Polyester, particulièrement robuste, avec couineur | Poliéster, especialmente resistente, con sonido | Poliester, particolarmente robusto, con squeaker | Polyester, særlig robust, med squeaker

8 cm 201356 13 cm 66413



III
3 Stck. | pcs.

Hundespielzeug KONG® TENNISHOES

Dog toy | Jouet pour chiens | Juguete para perros | Giocattolo per cani | Hundelegetøj

Polyester/Gummi, mit Squeaker, mit vier Tennisball-Beinen | *Polyester/Rubber, with squeaker, with four tennis ball legs* | Polyester/Caoutchouc, avec couineur, avec quatre jambes de balles de tennis | *Poliéster/De goma, con sonajero, con cuatro patas de pelota de tenis* | Poliestere/Gomma piena, con squeaker, con quattro gambe da tennis | *Polyester/Massivt gummi, med squeaker, med fire tennisboldben*

Giraffe | Giraffe | Girafe | Jirafa | Giraffa | Giraffe

25 cm 68857 



III
3 Stck. | pcs.

Hundespielzeug KONG® CUTESEAS™ OCTOPUS

Dog toy | Jouet pour chiens | Juguete para perros | Giocattolo per cani | Hundelegetøj

Kord, mit Squeaker, mit Knistergeräuschen | *Cord, with squeaker, with crackling noises* | Velours côtelé, avec couineur, avec des bruits de craquements | *Velluto a coste, con sonido, con sonido crujientes* | Pana, con squeaker, con rumori scoppiettanti | *Flojl, med squeaker, med knitrende lyde*

17 cm 66409  32 cm 66408 



III
3 Stck. | pcs.

Hundespielzeug KONG® CUTESEAS™ RUFFLEZ

Dog toy | Jouet pour chiens | Juguete para perros | Giocattolo per cani | Hundelegetøj | Hondenspeeltje KONG® Cuteseas Rufflez

Polyester, mit Squeaker | *Polyester, with squeaker* | Polyester, avec squeaker | *Poliéster, con chirriador* | Poliestere, con squeaker | *Polyester, med knirkende lyd*

1: Hai | Shark | Requin | Tiburón | Squalo | Haj

32 cm 207619 

2: Krabbe | Crab | Crabe | Cangrejo | Granchio | Krabbe

26 cm 207622 



III
3 Stck. | pcs.



III
3 Stck. | pcs.

Hundenspielzeug KONG® SHERPS™ FLOOFS

Dog toy | Jouet pour chiens | Juguete para perros | Giocattolo per cani | Hundelegetoj

Polyester/Kunststoff, mit Squeaker, mit Knistergeräuschen, besonders weich, doppellagig | *Polyester/Plastic, with squeaker, with crackling sounds, especially soft, double-layered* | Polyester/Plastique, avec couineur, avec bruits de crépitement, particulièrement doux, double couche | *Poliéster/Plástico, con sonido, con sonidos crepitantes, especialmente suave, de doble capa* | Poliestere/Plastica, con squeaker, con suoni scoppiettanti, particolarmente morbido, doppio strato | *Polyester/Plast, med squeaker, med knitrende lyde, særlig blød, dobbelt lag*

1: Schaf | Sheep | Mouton | Oveja | Pecora | Får

22 cm 69710

2: Elch | Moose | Élan | Alce | Alce | Elg

27 cm 69711

3: Big Horn

22 cm 69709

Hundenspielzeug KONG® SHERPS™

Dog toy | Jouet pour chiens | Juguete para perros | Giocattolo per cani | Hundelegetoj

Polyester, mit Squeaker, mit Knistergeräuschen, doppellagig | *Polyester, with squeaker, with crackling sounds, double-layered* | Polyester, avec squeaker, avec bruits de crépitement, double couche | *Poliéster, con chirriador, con sonidos crepitantes, de doble capa* | Poliestere, con squeaker, con suoni scoppiettanti, a doppio strato | *Polyester, med piver, med knitrende lyde, dobbeltlag*

1:Llama

21 cm 201359

2:Esel | Donkey | Âne | Burro | Asino | Æsel

20 cm 69296



III
3 Stck. | pcs.



assorted colours
III
4 Stck. | pcs.

Ein Spielzeug – zwei Gesichter
One toy - two characters

Hundenspielzeug KONG® SNUZZLES KIDDOS

Dog toy | Jouet pour chiens | Juguete para perros | Giocattolo per cani | Hundelegetøj

Polyester/Latex, prallgefüllter Körper, mit Squeaker, mit Knistergeräuschen | Polyester/Latex, plump shape, with squeaker, emits crackling noises | Polyester/Latex, corps bien rempli, avec couineur, avec bruits de craquement | Poliéster/Látex, cuerpo abultado, con sonajero, con jonido crujientes | Poliestere/Lattice, corpo rigonfio, con squeaker, con rumori scoppiettanti | Polyester/Latex, udbulet krop, med squeaker, med knitrende lyde

1: Bär | Bear | Ours | Oso | Orso | Bjørn

22 cm 69298

2: Hase | Rabbit | Lièvre | Liebre | Lepre | Hare

24 cm 69299

3: Koala

22 cm 69297

4: Elefant | Elephant | Éléphant | Elefante | Elefante | Elefant

20 cm 201336

Hundenspielzeug KONG® SWITCHEROOS

Dog toy | Jouet pour chiens | Juguete para perros | Giocattolo per cani | Hundelegetøj

Polyester, mit Squeakern in verschiedenen Tonlagen, zwei Designs in einem Spielzeug, farblich sortiert | Polyester, with squeakers in different pitches, two designs in one toy, assorted colours | Polyester, avec des squeakers de différentes tonalités, deux designs dans un seul jouet, couleurs assorties | De poliéster, con chirridos de diferentes tonos, dos diseños en un solo juguete, colores surtidos | Poliestere, con squittii di diverse tonalità, due design in un unico giocattolo, colori assortiti | Polyester, med pibere i forskellige tonehøjder, to designs i ét legetøj, farvemæssigt sorteret

31 cm 201354





III
2 Stck. | pcs.

Hundespielzeug KONG® SHAKERS™ CRUMPLES

Dog toy | Jouet pour chiens | Juguete para perros | Giocattolo per cani | Hundelegetoj

Polyester, mit Squeaker, mit Knistergeräuschen | *Polyester, with squeaker, with crackling sound* | Polyester, avec squeaker, avec bruits de crépitement | *Poliéster, con chirriador, con sonido crepitante* | Poliestere, con squeaker, con suono scoppiettante | *Polyester, med squeaker, med knitrende lyd*

1: Elefant | Elephant | Éléphant | Elefante | Elefante | Elefant

53 cm 207583 

2: Hase | Bunny | Lièvre | Liebre | Lepre | Hare

50 cm 207589 

3: Faultier | Sloth | Sloth | Pereza | Bradipo | Dovendyr

51 cm 207586 



III
3 Stck. | pcs.

Hundespielzeug KONG® SHAKERS™ SHIMMY

Dog toy | Jouet pour chiens | Juguete para perros | Giocattolo per cani | Hundelegetoj

Polyester/Kunstleder, mit Squeaker, mit Knistergeräuschen | *Polyester/Artificial Leather, with squeaker, with crackling sounds* | Polyester/Similicuir, avec squeaker, avec bruits de crépitement | *Poliéster/Cuero artificial, con chirriador, con sonido crepitante* | Poliestere/Similpelle, con squeaker, con suoni scoppiettanti | *Polyester/Kunstleder, med piver, med knitrende lyd*

1: Möwe | Seagull | Mouette | Gaviota | Gabbiano | Måge

28 cm 201364 

2: Krabbe | Crab | Crabe | Cangrejo | Granchio | Krabbe

43 cm 201337 



XXL



III
3 Stck. | pcs.

Hundespielzeug KONG® SHAKERS™ HONKERS

Dog toy | Jouet pour chiens | Juguete para perros | Giocattolo per cani | Hundelegetøj

Polyester, mit Squeaker | *Polyester, with squeaker* | Polyester, avec couineur | *Poliéster, con sonido* | Poliestere, con squeaker | *Polyester, med squeaker*

Ente | Duck | Canard | Pato | Anatra | And

27 cm 68470 45 cm 68471



assorted colours
III
3 Stck. | pcs.

Hundespielzeug KONG® SHAKERS™ CUCKOOS

Dog toy | Jouet pour chiens | Juguete para perros | Giocattolo per cani | Hundelegetøj

Polyester, mit Squeaker, mit Knistergeräuschen, verstärktes Futter, farblich sortiert | *Polyester, with squeaker, with crackling sounds, reinforced lining, assorted colours* | Polyester, avec squeaker, avec bruits de crépitement, doublure renforcée, couleurs assorties | *Poliéster, con chirriador, con sonidos crepitantes, forro reforzado, colores surtidos, colores surtidos* | Poliestere, con squeaker, con suoni scoppiettanti, fodera rinforzata, colori assortiti | *Polyester, med pivtøj, med knitrende lyde, forstærket foring, farvemæssigt sorteret*

32 cm 69720



XXL



III
3 Stck. | pcs.

Hundespielzeug KONG® SHAKERS™ LUVS

Dog toy | Jouet pour chiens | Juguete para perros | Giocattolo per cani | Hundelegetøj

Polyester, mit Squeaker, besonders langer Körper | *Polyester, with squeaker, extra long body* | Polyester, avec squeaker, corps particulièrement long | *Poliéster, con chirriador, cuerpo extra largo* | Poliestere, con squeaker, corpo extra lungo | *Polyester, med piver, ekstra lang krop*

Giraffe | Giraffe | Girafe | Jirafa | Giraffa | Giraffe

45 cm 69295



3 Stck. | pcs.

Hundenspielzeug KONG® SHIELDZ TROPICS

Dog toy | Jouet pour chiens | Juguete para perros | Giocattolo per cani | Hundelegetoj

Polyester/TPR, mit Squeaker, mit besonders haltbarer Beschichtung, leicht abwischbar, schwimmfähig | Polyester/TPR, with squeaker, with particularly durable coating, easy to wipe clean, floatable | Polyester/TPR, avec squeaker, avec un revêtement particulièrement durable, facile à essuyer, flottant | Poliéster/TPR, con chirriador, con revestimiento especialmente duradero, fácil de limpiar, flotante | Poliestere/TPR, con squeaker, con rivestimento particolarmente resistente, facile da pulire, galleggiante | Polyester/TPR, med knirk, med særligt holdbar belægning, let at tørre af, flyder

1: Tintenfisch | Octopus | Octopus | Pulpo | Polipo | Blæksprutte

16 cm 201361

2: Frosch | Frog | Grenouille | Rana | Rana | Frø

19 cm 201332



3 Stck. | pcs.

Hundenspielzeug KONG® WILD SHIELDZ

Dog toy | Jouet pour chiens | Juguete para perros | Giocattolo per cani | Hundelegetoj

Polyester, besonders robust durch dreifache Versiegelung, schwimmfähig | Polyester, particularly robust thanks to triple sealing, floatable | Polyester, particulièrement robuste grâce à un triple scellage, flottant | Poliéster, especialmente resistente gracias al triple sellado, flotante | Poliestere, particolarmente robusto grazie alla tripla sigillatura, galleggiabile | Polyester, særligt robust takket vare tredobbelt forsegling, flydende

1: Forelle | Trout | Truite | Trucha | Trota | Ørred

28 cm 207541

2: Barsch | Perch | Perche | Perca | Persico | Aborre

28 cm 207544



Besonders robust
Especially durable





III
3 Stck. | pcs.

Hundespielzeug KONG® WOZZLES

Dog toy | Jouet pour chiens | Juguete para perros | Giocattolo per cani | Hundelegetøj

Polyester, mit Squeaker, verstärktes Material | *Polyester, with squeaker, reinforced material* | Polyester, avec couineur, matière fortifiée | *Poliéster, con sonajero, material fortificado* | Poliestere, con squeaker, materiale fortificato | *Polyester, med squeaker, forstærket materiale*

blau | blue | bleu | azul | blu | blå

28 cm 68860 



III
2 Stck. | pcs.

Hundespielzeug KONG® TUGGZ™

Dog toy | Jouet pour chiens | Juguete para perros | Giocattolo per cani | Hundelegetøj

Polyester/Baumwolle, mit Squeaker, mit Knistergeräuschen | *Polyester/Cotton, with squeaker, emits crackling noises* | Polyester/Coton, avec couineur et bruits de craquement | *Poliéster/Algodón, con sonajero, sonido crujiente* | Poliestere/Cotone, con squeaker e rumori scoppiettanti | *Polyester/Bomuld, med squeaker, med knitrende lyd*

1: Faultier | Sloth | Sloth | Pereza | Bradipo | Dovendyr

42 cm 68861 

2: Affe | Monkey | Singe | Mono | Scimmia | Abe

42 cm 68862 



assorted colours

||||

3 Stck. | pcs.

Hundenspielzeug KONG® COZIE™

Dog toy | Jouet pour chiens | Juguete para perros | Giocattolo per cani | Humdelegetoj

Polyester, mit Squeaker, farblich sortiert | Polyester, with squeaker, assorted colours | Polyester, avec couineur, couleurs assorties | Poliéster, con sonido, colores surtidos | Poliestere, con squeaker, colori assortiti | Polyester, med squeaker, färvemässigt sorteret

23 cm 65036 



assorted colours

||||

3 Stck. | pcs.

Hundenspielzeug KONG® COZIE™ NATURALS

Dog toy | Jouet pour chiens | Juguete para perros | Giocattolo per cani | Humdelegetoj

Polyester, besonders robust, mit Squeaker, farblich sortiert | Polyester, particularly robust, with squeaker, assorted colours | Polyester, particulièrement robuste, avec squeaker, couleurs assorties | Poliéster, especialmente robusto, con chirriador, colores surtidos | Poliestere, particolarmente robusto, con squeaker, colori assortiti | Polyester, særligt robust, med pivtøj, färvemässigt sorteret

23 cm 201335 



||||

3 Stck. | pcs.

Hundenspielzeug KONG® COZIE™ TUGGZ CHEETAH

Dog toy | Jouet pour chiens | Juguete para perros | Giocattolo per cani | Humdelegetoj

Polyester/PVC/EVA, mit Squeaker, mit Knistergeräuschen, mit Knotenseil, kann bei der Zahnreinigung unterstützen | Polyester/PVC/EVA, with squeaker, with crackling sounds, with knotted rope, can help clean teeth | Polyester/PVC/EVA, avec squeaker, avec bruits de crépitement, avec corde à nœuds, peut aider au nettoyage des dents | Poliéster/PVC/EVA, con chirriador, con sonidos crepitantes, con cuerda anudada, puede ayudar a limpiar los dientes | Poliestere/PVC/EVA, con squeaker, con suoni scoppiettanti, con corda annodata, può aiutare a pulire i denti | Polyester/PVC/EVA, med pivter, med knitrende lyde, med knudret reb, kan hjælpe med at rense tænder

26 cm 201334 



XXL



IIII
2 Stck. | pcs.

Hundespielzeug KONG® JUMBO STRETCHZZ™

Dog toy | Jouet pour chiens | Juguete para perros | Giocattolo per cani | Hundelegetøj

Polyester, mit Knistergeräuschen, mit Squeaker | Polyester, with crackling noises, with squeaker | Polyester, avec des bruits de craquements, avec couineur | Poliéster, con sonido crujientes, con sonido | Poliestere, con rumori scoppiettanti, con squeaker | Polyester, med knitrende lyde, med squeaker

Leopard | Leopard | Léopard | Leopardo | Leopard | Leopard

60 cm 68475 



IIII
3 Stck. | pcs.

Hundespielzeug KONG® CARNIVAL KNOTS

Dog toy | Jouet pour chiens | Juguete para perros | Giocattolo per cani | Hundelegetøj

Polyester/Baumwolle, innenliegendes Knotenseil, minimale Füllung, mit Squeaker | Polyester/Cotton, knotted rope inside, minimal filling, with squeaker | Polyester/Coton, corde à nœuds à l'intérieur, rembourrage minimal, avec couineur | Poliéster/algodón, cuerda interior con nudos, relleno mínimo, con sonido | Poliestere/Cotone, corda con nodo interno, imbottitura minima, con squeaker | Polyester/Bomuld, Knudetov indeni, minimalt fyld, med squeaker

Elefant | Elephant | Éléphant | Elefante | Elefante | Elefant

18 cm 68481 



Verpackung ist ein separates Spielzeug
Packaging is a separate toy

III
3 Stck. | pcs.



III
3 Stck. | pcs.

2-in-1 Hundespielzeug KONG® COMFORT™ PUPS

Dog toy | Jouet pour chiens | Juguete para perros | Giocattolo per cani | Hundelegetøj

Polyester, minimale Füllung, mit Squeaker, 2 Spielzeuge in 1, Verpackung ist ein separates Spielzeug | *Polyester, minimal filling, with squeaker, 2 toys in 1, packaging is a separate toy* | Polyester, remplissage minimal, avec squeaker, 2 jouets en 1, l'emballage est un jouet séparé | *Poliéster, relleno mínimo, con chirriador, 2 juguetes en 1, el embalaje es un juguete aparte* | Poliestere, riempimento minimo, con squeaker, 2 giocattoli in 1, la confezione è un giocattolo separato | *Polyester, minimal fyldning, med squeaker, 2 stykker legetøj i 1, emballagen er et separat stykke legetøj*

1: Boss

22 cm 207532

2: Spot

33 cm 207529

3: Goldie

33 cm 207526

Hundespielzeug KONG® COMFORT™ KIDDOS

Dog toy | Jouet pour chiens | Juguete para perros | Giocattolo per cani | Hundelegetøj

Polyester, mit Squeaker | *Polyester, with squeaker* | Polyester, avec couineur | *Poliéster, con sonido* | Poliestere, con squeaker | *Polyester, med squeaker*

Bär | Bear | Ours | Oso | Orso | Bjørn

22 cm 67383



Hundespielzeug KONG® COMFORT JUMBO™ BIRDS

Dog toy | Jouet pour chiens | Juguete para perros | Giocattolo per cani | Hundelegetøj

Polyester, mit zwei Squeakern, extra langer Plüsch, farblich sortiert | Polyester, with two squeakers, extra long plush, assorted colours | Polyester, avec deux squeakers, peluche extra longue, couleurs assorties | Poliéster, con dos sonidos, felpa extralarga, colores surtidos | Poliester, con due suoni, peluche extra lungo, colori assortiti | Polyester, med to lyde, ekstra lang plys, färvemässigt sorteret

50 cm 201350 

XXL

assorted colours

III
3 Stck. | pcs.



Hundespielzeug KONG® COMFORT HEDGEHUG™ PUPPY

Dog toy | Jouet pour chiens | Juguete para perros | Giocattolo per cani | Hundelegetøj

Polyester, mit Squeaker, mit Knistergeräuschen, farblich sortiert | Polyester, with squeaker, with crackling noises, assorted colours | Polyester, avec couineur, avec des bruits de craquements, couleurs assorties | Poliéster, con sonido, con sonido crujientes, colores surtidos | Poliester, con squeaker, con rumori scoppiettanti, colori assortiti | Polyester, med squeaker, med knitrende lyde, färvemässigt sorteret

9,5 cm 201355 

assorted colours

III
4 Stck. | pcs.



3 Stck. | pcs.

Hundenspielzeug KONG® WILD KNOTS

Dog toy | Jouet pour chiens | Juguete para perros | Giocattolo per cani | Hundelegetoj

PE/Polyester, mit Squeaker, mit Knistergeräuschen, Skelett aus Knotenseil, weich und stabil | *PE/polyester, with squeaker, with crackling sounds, skeleton made of knotted rope, soft and stable* | PE/polyester, avec squeaker, avec bruits de crépitement, squelette en corde à nœuds, souple et stable | *PE/poliéster, con chirriador, con sonidos crepitantes, esqueleto de cuerda anudada, blando y estable* | PE/poliestere, con squeaker, con suoni scoppiettanti, scheletro in corda annodata, morbido e stabile | *PE/polyester, med piver, med knitrende lyde, skelet af knyttet reb, blødt og stabilt*

1: Giraffe | Giraffe | Girafe | Jirafa | Giraffa | Giraffe

24 cm 201333

2: Tiger | Tiger | Tigre | Tigre | Tigre | Tiger

27 cm 201358



3 Stck. | pcs.

Hundenspielzeug KONG® FLOPPY KNOTS

Dog toy | Jouet pour chiens | Juguete para perros | Giocattolo per cani | Hundelegetoj

Polyester/Baumwolle, Skelett aus Knotenseil, mit Squeaker, wenig Füllung, weich und stabil | *Polyester/Cotton, knotted rope skeleton, with squeaker, minimal filling, soft and tough* | Polyester/Coton, squelette en corde à nœuds, avec couineur, peu de garnissage, doux et résistant | *Poliéster/Algodón, esqueleto de nodo, con sonido, poco relleno, suave y estable* | Poliestere/Cotone, struttura in corda con nodi, con squeaker, piccola imbottitura, morbido e stabile | *Polyester/Bomuld, skelet af knyttet reb, med squeaker, lidt fyld, blødt og stabilt*

1: Elefant | Elephant | Éléphant | Elefante | Elefante | Elefant

36 cm 67381

2: Fuchs | Fox | Renard | Zorro | Volpe | Fox

23,5 cm 201357



assorted colours

3 Stck. | pcs.

Hundenspielzeug KONG® DRAGON KNOTS

Dog toy | Jouet pour chiens | Juguete para perros | Giocattolo per cani | Hundelegetoj

Polyester/Baumwolle, besonders robust, mit Squeaker, mit Knistergeräuschen, farblich sortiert | *Polyester/Cotton, extremely robust, with squeaker, with crackling noises, assorted colours* | Polyester/Coton, particulièrement robuste, avec couineur, avec des bruits de craquements, couleurs assorties | *Poliéster/Algodón, especialmente resistente, con sonido, con sonido crujientes, colores surtidos* | Poliestere/Cotone, particolarmente robusto, con squeaker, con rumori scoppiettanti, colori assortiti | *Polyester/Bomuld, særlig robust, med squeaker, med knitrende lyde, farvemæssigt sorteret*

24 cm 66412



Minimale Füllung & Skelett aus Knotenseil
Minimal filling & knotted rope



assorted colours

	⇒	■i	
XS	10 cm	4 Stck.	pcs.
S/M	18 cm	3 Stck.	pcs.
M/L	28 cm	3 Stck.	pcs.
XL	30 cm	2 Stck.	pcs.



assorted colours

3 Stck. pcs.

Hundenspielzeug KONG® WILD KNOTS BEARS

Dog toy | Jouet pour chiens | Juguete para perros | Giocattolo per cani | Hundelegetøj

Polyester/Baumwolle, mit Squeaker, Skelett aus Knotenseil, weich und stabil, farblich sortiert | Polyester/Cotton, with squeaker, knotted rope skeleton, soft and sturdy, assorted colours | Polyester/Coton, avec couineur, squelette en corde à nœuds, doux et résistant, couleurs assorties | Poliéster/Algodón, con sonido, esqueleto de cuerda anudada, suave y resistente, colores surtidos | Poliestere/Cotone, con squeaker, scheletro con corda di ossa, morbido e stabile, colori assortiti | Polyester/Bomuld, med squeaker, skelett i sejlto, blød og stabil, farvemæssigt sorteret

XS	65393		S/M	65020	
M/L	65025		XL	65394	



Hundenspielzeug KONG® KNOTS TWISTS

Dog toy | Jouet pour chiens | Juguete para perros | Giocattolo per cani | Hundelegetøj

Polyester, mit Squeaker, mit Knotenseil, kann bei der Zahnreinigung unterstützen, farblich sortiert | Polyester, with squeaker, with knotted rope, can help to clean teeth, assorted colours | Polyester, avec squeaker, avec corde à noeuds, peut aider à nettoyer les dents, couleurs assorties | Poliéster, con chirriador, con cuerda anudada, complementa la limpieza dental, colores surtidos, colores surtidos | Poliestere, con squeaker, con corda annodata, può aiutare nella pulizia bucale, colori assortiti | Polyester, med pivtøj, med knudret reb, kan understøtte tandrensning, farvemæssigt sorteret

28 cm	69722		32 cm	69723	
-------	-------	--	-------	-------	--





Hundenspielzeug KONG® SCRUNCH KNOTS FOX

Dog toy | Jouet pour chiens | Juguete para perros | Giocattolo per cani | Hundelegetøj

Polyester/Baumwolle, mit Squeaker, innenliegendes Knotenseil, dehnbare Seiten, weicher Plüsch | Polyester/cotton, with squeaker, internal knotted rope, stretchy sides, soft plush | Polyester/coton, avec squeaker, corde à nœuds à l'intérieur, côtés extensibles, peluche douce | Poliéster/algodón, con chirriador, cuerda interna anudada, laterales elásticos, felpa suave | Poliestere/cotone, con squeaker, corda interna annodata, lati elastici, morbido peluche | Polyester/bomuld, med piver, indvendigt knudret reb, strækbare sider, blødt plys

40 cm 201360 

III
3 Stck. | pcs.



Hundenspielzeug KONG® TUGGER KNOTS®

Dog toy | Jouet pour chiens | Juguete para perros | Giocattolo per cani | Hundelegetøj

Polyester, mit Squeaker, robust, interaktives Zerrspielzeug mit Baumwollkordeln | Polyester, with squeaker, robust, interactive tugging toy with cotton ropes | Polyester, avec couineur, jouet à tirer interactif et robuste avec cordons en coton | Poliéster, con sonido, juguete resistente e interactivo con cordones de algodón | Poliestere, con squeaker, gioco da mordicchiare resistente e interattivo fatto di cordoncini in cotone | Polyester, med squeaker, robust, interaktivt ruskelegetøj med bomuldsnøre

1: Affe | Monkey | Singe | Mono | Scimmia | Abe

36 cm 62595 

2: Frosch | Frog | Grenouille | Rana | Rana | Frø

38 cm 68855 

3: Elch | Moose | Élan | Alce | Alce | Elg

50 cm 68856 

III
3 Stck. | pcs.



Hundenspielzeug KONG® SNEAKERZ KNOTS

Dog toy | Jouet pour chiens | Juguete para perros | Giocattolo per cani | Hundelegetøj

Polyester/Baumwolle, mit Squeaker, mit Knistergeräuschen, innenliegendes Knotenseil, farblich sortiert | Polyester/Cotton, with squeaker, with crackling sounds, knotted rope inside, assorted colours | Polyester/Coton, avec squeaker, avec bruits de crépitements, corde à nœuds à l'intérieur, couleurs assorties | Poliéster/Algodón, con chirriador, con sonidos crepitantes, cuerda anudada en el interior, colores surtidos, colores surtidos | Poliestere/Cotone, con squeaker, con suoni scoppiettanti, corda annodata all'interno, colori assortiti | Polyester/Bomuld, med piver, med knitrende lyde, med knudret reb indeni, farvemæssigt sorteret

41 cm 69721 

assorted colours III
4 Stck. | pcs.



Näpfe

— *Bowls* —

Aus Näpfen unterschiedlichster Materialien und Formen darf geschlemmt werden. Ob Edelstahl, Melamin, Kunststoff oder auch Keramik – für die individuellen Vorlieben Ihres Hundes bieten wir eine riesige Auswahl.

Your dog can feast from bowls of different materials and shapes. Made from stainless steel, melamine, plastic or ceramic - we offer a huge selection to suit the individual preferences of your furry friend.



KERAMIK
Ceramic

Keramik-Napf LUND

Ceramic bowl | Bol en céramique | Plato de cerámica | Ciotola in ceramica | Keramik drikkekop

Keramik, Silikonrand am Boden ist rutschhemmend und beugt Kratzern auf dem Untergrund vor, spülmaschinengeeignet, mit HUNTER-Prägung | *Ceramic, silicon edge stops the bowl from slipping and prevents your floor from being scratched, dishwasher-safe, with HUNTER logo* | *Céramique, le bord en silicone sur la partie inférieure est antidérapant et permet d'éviter les rayures sur le sol, lavable au lave-vaisselle, avec logo HUNTER en relief* | *Cerámica, con borde de silicona en la base para evitar que se deslice y que se raye la superficie inferior, seguro para el lavavajillas, con estampado de HUNTER* | *Ceramica, il bordo in silicone sul pavimento offre resistenza allo scivolamento e previene i graffi sulla superficie, lavabile in lavastoviglie, con goffratura HUNTER* | *Keramik, silikone kant på gulvet sikrer skridsikkerhed og forhindrer ridser på jorden, tåler opvaskemaskine, med HUNTER prægning*

weiß | white | blanc | blanco | bianco | hvid

310 ml 67433  550 ml 67434 

900 ml 67435  1500 ml 67436 

grau | grey | gris | gris | grigio | grå

310 ml 67429  550 ml 67430 

900 ml 67431  1500 ml 67432 

schwarz | black | noir | negro | nero | sort

310 ml 68412  550 ml 68413 

900 ml 68414  1500 ml 68415 

☰	Ø	
310 ml	11 cm	2 Stck. pcs.
550 ml	13 cm	2 Stck. pcs.
900 ml	16 cm	2 Stck. pcs.
1500 ml	20 cm	2 Stck. pcs.

Lässig und modern integriert sich der Keramiknapf LUND vom ersten Moment an in Ihr Zuhause. Die angenehm natürlichen Farben und die klassische Form mit edel geprägter Hunde-Silhouette stehen für Ursprünglichkeit und Beständigkeit. Dank umlaufendem Silikonrand am Boden und dem verhältnismäßig hohen Eigengewicht steht der Napf besonders sicher und wird auch von sensiblen Hunden gern angenommen. Wer auf der Suche nach einem langlebigen, stabilen und pflegeleichten Napf ist, in dem Futter und Wasser tagtäglich besonders stilvoll serviert werden können, sollte bei LUND hellhörig werden.

The LUND ceramic feeding bowl is a casual and modern addition to any home. The pleasant natural colours and classic bowl form with the elegant dog silhouette imprint make your pet feel right at home. Thanks to the silicon edge around the bottom of the bowl and its relatively weighty design, the bowl doesn't move around on the floor and is also suitable for particularly sensitive dogs. If you're on the lookout for a long-lasting, robust and easy-care bowl that can be used to serve food and water every day with style, then LUND is the right bowl for you.

Silikonrand am Boden sorgt für Rutschfestigkeit und beugt Kratzern auf dem Untergrund vor

Silicon edge stops the bowl from slipping and prevents your floor from being scratched





▣	Ø	
350 ml	11 cm	2 Stck. pcs.
550 ml	13 cm	2 Stck. pcs.
1100 ml	16 cm	2 Stck. pcs.
1900 ml	20 cm	2 Stck. pcs.
2500 ml	22 cm	2 Stck. pcs.

Silikonrand am Boden sorgt für Rutschfestigkeit und beugt Kratzern auf dem Untergrund vor
Silicon edge stops the bowl from slipping and prevents the floor from being scratched

Keramik-Napf Osby

Ceramic bowl | Bol en céramique | Plato de cerámica | Ciotola in ceramica | Keramik drikkekop

Keramik, Silikonrand am Boden ist rutschhemmend und beugt Kratzern auf dem Untergrund vor, spülmaschineneignet, mit HUNTER-Prägung | *Ceramic, silicon edge stops the bowl from slipping and prevents your floor from being scratched, dishwasher-safe, with HUNTER logo* | Céramique, le bord en silicone sur la partie inférieure est antidérapant et permet d'éviter les rayures sur le sol, lavable au lave-vaisselle, avec logo HUNTER en relief | *Cerámica, con borde de silicona en la base para evitar que se deslice y que se raye la superficie inferior, seguro para el lavavajillas, con estampado de HUNTER* | *Ceramica, il bordo in silicone sul pavimento offre resistenza allo scivolamento e previene i graffi sulla superficie, lavabile in lavastoviglie, con goffratura HUNTER* | *Keramik, silikone kant på gulvet sikrer skridsikkerhed og forhindrer ridser på jorden, tåler opvaskemaskine, med HUNTER prægning*

weiß | white | blanc | blanco | bianco | hvid

350 ml 69700 550 ml 69701

1100 ml 69702 1900 ml 69703

khaki | kaki | kaki | caqui | cachi | kaki

350 ml 68987 550 ml 68988

1100 ml 68989 1900 ml 68990

taupe

350 ml 68983 550 ml 68984

1100 ml 68985 1900 ml 68986

anthrazit | anthracite | anthracite | anthracita | anthracite | antracit

350 ml 68978 550 ml 68979

1100 ml 68980 1900 ml 68981

2500 ml 68982





KERAMIK
Ceramic



XXL
2500 ml

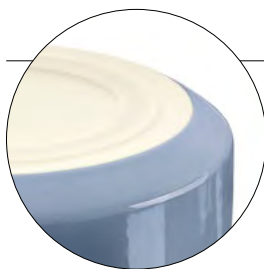

Capacity	Ø	Quantity
350 ml	11 cm	2 Stck. pcs.
550 ml	13 cm	2 Stck. pcs.
1100 ml	16 cm	2 Stck. pcs.
1900 ml	20 cm	2 Stck. pcs.
2500 ml	22 cm	2 Stck. pcs.

Silikonrand am Boden sorgt für Rutschfestigkeit und beugt Kratzern auf dem Untergrund vor

Silicon edge stops the bowl from slipping and prevents the floor from being scratched

Wir haben OSBY auf hochglanz gebracht!
We have given OSBY a high gloss finish!

Keramik-Napf OSBY GLAZED

Ceramic bowl | Bol en céramique | Plato de cerámica | Ciotola in ceramica | Keramik drikkekop

Keramik, Silikonrand am Boden ist rutschhemmend und beugt Kratzern auf dem Untergrund vor, spülmaschineneeignet, mit HUNTER-Prägung | Ceramic, silicon edge stops the bowl from slipping and prevents your floor from being scratched, dishwasher-safe, with HUNTER logo | Céramique, le bord en silicone sur la partie inférieure est antidérapant et permet d'éviter les rayures sur le sol, lavable au lave-vaisselle, avec logo HUNTER en relief | Cerámica, con borde de silicona en la base para evitar que se deslice y que se raye la superficie inferior, seguro para el lavavajillas, con estampado de HUNTER | Ceramica, il bordo in silicone sul pavimento offre resistenza allo scivolamento e previene i graffi sulla superficie, lavabile in lavastoviglie, con goffratura HUNTER | Keramik, silikone kant på gulvet sikrer skridsikkerhed og forhindrer ridser på jorden, tåler opvaskemaskine, med HUNTER prægning

beige | tan | beige | beige | beige | beige

350 ml 204952  550 ml 204955 

1100 ml 204958  1900 ml 204961 

2500 ml 204964 

orange | orange | orange | naranja | arancione | orange

350 ml 204982  550 ml 204985 

1100 ml 204988  1900 ml 204991 

2500 ml 204994 

taubenblau | dove blue | bleu pigeon | azul paloma | blu colomba | dueblå

350 ml 204967  550 ml 204970 

1100 ml 204973  1900 ml 204976 

2500 ml 204979 







KERAMIK
Ceramic



h	Ø	III
350 ml	11 cm	2 Stck. pcs.
550 ml	13 cm	2 Stck. pcs.
1100 ml	16 cm	2 Stck. pcs.
1900 ml	20 cm	2 Stck. pcs.

Silikonrand am Boden sorgt für Rutschfestigkeit und beugt Kratzern auf dem Untergrund vor
Silicon edge stops the bowl from slipping and prevents your floor from being scratched

Keramik-Napf EIBY

Ceramic bowl | Bol en céramique | Plato de cerámica | Ciotola in ceramica | Keramik drikkekop

Keramik, Silikonrand am Boden ist rutschhemmend und beugt Kratzern auf dem Untergrund vor, spülmaschinengeeignet, mit HUNTER-Prägung | *Ceramic, silicon edge stops the bowl from slipping and prevents your floor from being scratched, dishwasher-safe, with HUNTER logo* | *Céramique, le bord en silicone sur la partie inférieure est antidérapant et permet d'éviter les rayures sur le sol, lavable au lave-vaisselle, avec logo HUNTER en relief* | *Cerámica, con borde de silicona en la base para evitar que se deslice y que se raye la superficie inferior, seguro para el lavavajillas, con estampado de HUNTER* | *Ceramica, il bordo in silicone sul pavimento offre resistenza allo scivolamento e previene i graffi sulla superficie, lavabile in lavastoviglie, con goffratura HUNTER* | *Keramik, silikone kant på gulvet sikrer skridsikkerhed og forhindrer ridser på jorden, tåler opvaskemaskine, med HUNTER prægning*

gelb | yellow | jaune | amarillo | giallo | gul

350 ml 68652  550 ml 68653 

1100 ml 68654  1900 ml 68655 

blau | blue | bleu | azul | blu | blå

350 ml 68648  550 ml 68649 

1100 ml 68650  1900 ml 68651 

grau | grey | gris | gris | grigio | grå

350 ml 68656  550 ml 68657 

1100 ml 68658  1900 ml 68659 





Jeder Napf ein Unikat *Every bowl is unique*

Die hochwertigen Keramiknäpfe mit ihrer aufwändigen Glasur verzaubern durch ihr changierendes Farbspiel in dezenten Tönen. Jedes Stück ist ein wunderschönes Unikat, das jeden Wohnraum aufwertet und auf perfekt unperfekte Weise mit den gewollten Farbabweichungen und Spreckeln den Essplatz für den Vierbeiner zu etwas ganz Besonderem macht.

The high-quality ceramic bowls with their intricate glaze enchant with their iridescent play of colours in subtle tones. Each piece is a beautiful unique specimen that enhances every living space and makes the dining area for your four-legged friend something very special in a perfectly imperfect way with the deliberate colour deviations and speckles.



Reaktive Lasur

So individuell und liebenswert jeder einzelne Hund ist, so unterschiedlich ist auch jeder Napf aus der Serien LISBOA & BRAGA.

Reactive glaze

As individual and lovable as every single dog is, so different is every bowl from the LISBOA & BRAGA series.





Silikonrand am Boden sorgt für Rutschfestigkeit und beugt Kratzern auf dem Untergrund vor

Silicon edge stops the bowl from slipping and prevents your floor from being scratched

▨	Ø	
310 ml	11,5 cm	2 Stck. pcs.
550 ml	13,5 cm	2 Stck. pcs.
900 ml	17,0 cm	2 Stck. pcs.
1500 ml	20,5 cm	2 Stck. pcs.

Keramik-Napf LISBOA

Ceramic bowl | Bol en céramique | Plato de cerámica | Ciotola in ceramica | Keramik drikkekop

Keramik, Silikonrand am Boden ist rutschhemmend und beugt Kratzern auf dem Untergrund vor, spülmaschinengeeignet | *Ceramic, silicon edge stops the bowl from slipping and prevents your floor from being scratched, dishwasher-safe* | Céramique, le bord en silicone sur la partie inférieure est antidérapant et permet d'éviter les rayures sur le sol, lavable au lave-vaisselle | *Cerámica, con borde de silicona en la base para evitar que se deslice y que se raye la superficie inferior, seguro para el lavavajillas* | Ceramica, il bordo in silicone sul pavimento offre resistenza allo scivolamento e previene i graffi sulla superficie, lavabile in lavastoviglie | *Keramik, silikone kant på gulvet sikrer skridsikkerhed og forhindrer ridser på jorden, tåler opvaskemaskine*

creme | cream | crème | crema | crema | creme

310 ml 69987  550 ml 69988 

900 ml 69989  1500 ml 69990 

KERAMIK

Ceramic



Silikonrand am Boden sorgt für Rutschfestigkeit und beugt Kratzern auf dem Untergrund vor

Silicon edge stops the bowl from slipping and prevents your floor from being scratched

▨	Ø	
310 ml	11,5 cm	2 Stck. pcs.
550 ml	13,5 cm	2 Stck. pcs.
900 ml	17,0 cm	2 Stck. pcs.
1500 ml	20,5 cm	2 Stck. pcs.

Keramik-Napf BRAGA

Ceramic bowl | Bol en céramique | Plato de cerámica | Ciotola in ceramica | Keramik drikkekop

Keramik, Silikonrand am Boden ist rutschhemmend und beugt Kratzern auf dem Untergrund vor, spülmaschinengeeignet | *Ceramic, silicon edge stops the bowl from slipping and prevents your floor from being scratched, dishwasher-safe* | Céramique, le bord en silicone sur la partie inférieure est antidérapant et permet d'éviter les rayures sur le sol, lavable au lave-vaisselle | *Cerámica, con borde de silicona en la base para evitar que se deslice y que se raye la superficie inferior, seguro para el lavavajillas* | Ceramica, il bordo in silicone sul pavimento offre resistenza allo scivolamento e previene i graffi sulla superficie, lavabile in lavastoviglie | *Keramik, silikone kant på gulvet sikrer skridsikkerhed og forhindrer ridser på jorden, tåler opvaskemaskine*

blau | blue | bleu | azul | blu | blå

310 ml 69983  550 ml 69984 

900 ml 69985  1500 ml 69986 

KERAMIK

Ceramic



rutschhemmende Unterseite
non-slip bottom



Melamin-Napf

Melamine feeding bowl | Mélamine écuelle | Melamina comedero | Ciotola in melamina | Melamin-foderskål

Melamin-Gehäuse, Edelstahlnapf herausnehmbar, rutschhemmende Unterseite, spülmaschinengeeignet | Melamine case, stainless steel dish removable, non-slip bottom, dishwasher-safe | Boîtier en mélamine, écuelle en acier inoxydable, partie inférieure antidérapante, lavable au lave-vaisselle | Carcasa de melamina, comedero de acero inoxidable extraíble, seguro para el lavavajillas | Alloggiamento in melamina, ciotola estraibile in acciaio inox, fondo antiscivolo, lavabile in lavastoviglie | Melaminhus, udtagelig foderskål i rustfrit stål, skridsikker bund, tåler opvaskemaskine

🍽	∅	
160 ml	14 cm	2 Stck. pcs.
350 ml	18 cm	2 Stck. pcs.
700 ml	22 cm	2 Stck. pcs.

1: Mayfair

160 ml 204859 350 ml 204862

700 ml 204865

2: Chester

160 ml 204871 350 ml 204874

700 ml 204877

3: Kington

160 ml 204883 350 ml 204886

700 ml 204889

4: Luton

160 ml 204895 350 ml 204898

700 ml 204901



5: Mogami

160 ml 65140 350 ml 65141

700 ml 65142

6: Aarhus

160 ml 64467 350 ml 64468

700 ml 64469

7: Valencia

160 ml 67659 350 ml 67660

700 ml 67661

8: Burgos

160 ml 67663 350 ml 67664

700 ml 67665

9: Silda weiß/grau | white/grey | blanc/gris | blanco/gris | bianco/grigio | hvid/grå

160 ml 68664 700 ml 68666

10: Silda anthrazit/weiß | anthracite/white | anthracite/blanc | antracita/blanco |
antracite/bianco | anthrazit/hvid

160 ml 68668 350 ml 68669

700 ml 68670

11: Biri

160 ml 68660 350 ml 68661

700 ml 68662

12: FC Bayern München

160 ml 69237 350 ml 69238

700 ml 69239

13: BVB

160 ml 68573 700 ml 68575



▣	∅	
160 ml	14 cm	2 Stck. pcs.
350 ml	18 cm	2 Stck. pcs.
700 ml	22 cm	2 Stck. pcs.
1400 ml	27 cm	2 Stck. pcs.

Melamin-Napf

Melamine feeding bowl | Mélamine écuelle | Melamina comederu | Ciotola in melamina | Melamin-foderskål

Melamin-Gehäuse, Edelstahlnapf herausnehmbar, rutschhemmende Unterseite, spülmaschinengeeignet | Melamine case, stainless steel dish removable, non-slip bottom, dishwasher-safe | Boîtier en mélamine, écuelle en acier inoxydable, partie inférieure antidérapante, lavable au lave-vaisselle | Carcasa de melamina, comederu de acero inoxidable extraíble, seguro para el lavavajillas | Alloggiamento in melamina, ciotola estraibile in acciaio inox, fondo antiscivolo, lavabile in lavastoviglie | Melaminhus, udtagelig foderskål i rustfrit stål, skridsikker bund, tåler opvaskemaskine

weiß | white | blanc | blanco | bianco | hvid

160 ml 91362 350 ml 91363

700 ml 91364 1400 ml 92091

orange | orange | orange | naranja | arancione | orange

160 ml 91365

rot | red | rouge | rojo | rosso | rød

160 ml 92084

petrol | teal | pétrole | petróleo | petrolio | petrol

160 ml 92023 700 ml 92025

hellgrün | light green | vert clair | verde claro | verde chiaro | lysegrøn

350 ml 91858 700 ml 91859

khaki | kaki | kaki | caqui | cachi | kaki

160 ml 204907 350 ml 204910

700 ml 204913

grau | grey | gris | gris | grigio | grå

160 ml 92087 350 ml 92088

700 ml 92089

schwarz | black | noir | negro | nero | sort

160 ml 91368 350 ml 91369

700 ml 91370 1400 ml 92090





Anti-Schlingnapf ATLANTA

Slow feeding bowl | Gamelle anti-glouton | Comedero anti voracidad | Ciotola anti ingozzamento | Anti-slugeskål

Melamin, verhindert ein Herunterschlingen des Futters, rutschhemmende Unterseite, spülmaschinengeeignet | *Melamine, stops food being wolfed down, non-slip bottom, dishwasher-safe* | *Mélamine, empêche que la nourriture ne soit avalée trop vite, partie inférieure antidérapante, lavable au lave-vaisselle* | *Melamina, evitar ingerir el pienso con voracidad, base antideslizante, seguro para el lavavajillas* | *Melamina, impedisce lo scivolamento del cibo, fondo antiscivolo, lavabile in lavastoviglie* | *Melamin, forhindrer at maden sluges, skridsikker bund, tåler opvaskemaskine*

grau | grey | gris | gris | grigio | grå

550 ml 66580  900 ml 66581 

▣	∅	▣▣▣
550 ml	21 cm	2 Stck. pcs.
900 ml	25 cm	2 Stck. pcs.



Ersatznapf für Melamin-Näpfe

Spare bowl for melamine bowls | Gamelle de remplacement pour des gamelles en mélamine | Bebedero de repuesto para bebederos de melamina | Ciotola di ricambio per ciotole in melamina | Ekstra melamin-skål

Edelstahl, passt für alle HUNTER Melamin-Näpfe, spülmaschinengeeignet | *Stainless steel, fits all HUNTER melamine bowls, dishwasher-safe* | *Acier inoxydable, appropriée pour toutes les écuelles à alimentation en mélamine, lavable au lave-vaisselle* | *Acero inoxidable, adecuado para toda las clases de comederos de melamina, seguro para el lavavajillas* | *Acciaio inossidabile, adatta a tutte portaciotole in melamina, lavabile in lavastoviglie* | *Rustfrit stål, passer til alle melaminskåle, tåler opvaskemaskine*

▣▣▣
2 Stck. | pcs.

160 ml 91949  350 ml 91950 

700 ml 91951  1400 ml 92211 





🍽	⇒	Ø	
190 ml	XS	12 cm	2 Stck. pcs.
350 ml	S	12 cm	2 Stck. pcs.
550 ml	M	14 cm	2 Stck. pcs.
1100 ml	L	17 cm	2 Stck. pcs.
1900 ml	XL	21 cm	2 Stck. pcs.
2700 ml	XXL	24 cm	2 Stck. pcs.



🍽	⇒	Ø	
350 ml	S	11 cm	2 Stck. pcs.
550 ml	M	14 cm	2 Stck. pcs.
1050 ml	L	17 cm	2 Stck. pcs.
1750 ml	XL	20 cm	2 Stck. pcs.
2600 ml	XXL	24 cm	2 Stck. pcs.
4100 ml	XXXL	28 cm	2 Stck. pcs.

Futternapf EDELSTAHL

Feeding bowl | Écuellen | Comedero | Ciotola per il cibo | Foderskål

Edelstahl, Silikonrand am Boden ist rutschhemmend und beugt Kratzern auf dem Untergrund vor, spülmaschinengeeignet | *Stainless steel, silicon coating on the base makes it sturdy and prevents scratching on the surface below, dishwasher-safe* | Acier inoxydable, le revêtement en silicone à sa base empêche les glissements et prévient les rayures sur le support, lavable au lave-vaisselle | *Acero inoxidable, el revestimiento de silicona en la base proporciona resistencia antideslizante y evita arañazos en la base, seguro para el lavavajillas* | Acciaio inossidabile, il rivestimento in silicone della base fornisce resistenza allo scivolamento e previene i graffi sul fondo, lavabile in lavastoviglie | *Rustfrit stål, silikonebund sørger for skridsikkerhed og forhindrer ridser i gulvet, tåler opvaskemaskine*

Edelstahl | Stainless steel | Acier inoxydable | Acero inoxidable | Acciaio inossidabile | Rustfrit stål

190 ml	46589		350 ml	41711	
550 ml	41712		1100 ml	41713	
1900 ml	41714		2700 ml	41715	

Edelstahnapf NAMV

Stainless steel bowl | Gamelle en inox | Cuenco de acero inoxidable | Ciotola in acciaio inox | Madskål af rustfrit stål

Edelstahl, verspiegelte Innenfläche, Silikonummantelung am Boden ist rutschhemmend und beugt Kratzern auf dem Untergrund vor, spülmaschinengeeignet | *Stainless steel, mirrored inner surface, silicon coating on the base makes it sturdy and prevents scratching on the surface below, dishwasher-safe* | Acier inoxydable, surface intérieure réfléchissante, le revêtement en silicone à sa base empêche les glissements et prévient les rayures sur le support, lavable au lave-vaisselle | *Acero inoxidable, superficie interior reflejante, el revestimiento de silicona en la base proporciona resistencia antideslizante y evita arañazos en la base, seguro para el lavavajillas* | Acciaio inossidabile, superficie interna a specchio, in acciaio inox, il rivestimento in silicone della base fornisce resistenza allo scivolamento e previene i graffi sul fondo, lavabile in lavastoviglie | *Rustfrit stål, spejlbelagt inderside, silikonebund sørger for skridsikkerhed og forhindrer ridser i gulvet, tåler opvaskemaskine*

Edelstahl | Stainless steel | Acier inoxydable | Acero inoxidable | Acciaio inossidabile | Rustfrit stål



350 ml	69530		550 ml	69531	
1050 ml	69532		1750 ml	69533	
2600 ml	69534		4100 ml	69535	



Hundebar BASIC

Dog bar | Bar pour chiens | Soporte con comederos para perros | Portaciotole | Hundebar

Edelstahlnäpfe herausnehmbar, spülmaschinengeeignet, stufenlos höhenverstellbar | *Stainless steel bowls removable, dishwasher-safe, individually adjustable height* | Écuelles en acier inoxydable amovibles, lavable au lave-vaisselle, réglable en hauteur en continu | *Comederos de acero inoxidable extraíbles, seguro para el lavavajillas, altura regulable sin escalonamiento* | Ciotole estraibile in acciaio inox, lavabile in lavastoviglie, regolabile in altezza in continuo | *Udtagelig foderskåle i rustfrit stål, tåler opvaskemaskine, trinløs højdejusterbar*

2 x 1,8 l 91344  2 x 2,7 l 91345 

☞	☛
2 x 1,8 l	12 – 40 cm
2 x 2,7 l	12 – 50 cm





IIII
2 Stck. | pcs.

Napfunterlage SELECTION ROUND

Food bowl base | Set de table pour accueillir une gamelle | Bandeja para platos de mascotas | Sottociotole | Skålunderlag

Silikon, spülmaschinengeeignet, mit extra hohem Rand um Flüssigkeiten aufzuhalten | *Silicone, dishwasher-safe, with extra high rim to keep fluids from spilling* | Silicone, lavable au lave-vaisselle, avec rebord particulièrement haut pour retenir les liquides | *Silicona, seguro para el lavavajillas, con bordes más altos para mantener los líquidos* | Silicone, lavabile in lavastoviglie, con bordo extra alto per non far traboccare i liquidi | *Silikone, tåler opvaskemaskine, med ekstra høj kant for at beskytte mod væsker*

transparent | transparent | transparent | transparente | trasparente | transparent

38 cm 69004

anthrazit | anthracite | anthracite | anthracita | anthracite | antracit

38 cm 69005

Napfunterlage SELECTION FOLDABLE

Food bowl base | Set de table pour accueillir une gamelle | Bandeja para platos de mascotas | Sottociotole | Skålunderlag

Silikon, spülmaschinenfest, platzsparend faltbar, mit extra hohem Rand um Flüssigkeiten aufzuhalten | *Silicone, dishwasher-safe, folds up to save space, with extra high rim to keep fluids from spilling* | Silicone, peut être placé dans le lave-vaisselle, pliante pour réduire l'encombrement, avec rebord particulièrement haut pour retenir les liquides | *Silicona, resistente al lavavajillas, plegable para ahorrar espacio, con bordes más altos para mantener los líquidos* | Silicone, lavabile in lavastoviglie, struttura pieghevole salvaspazio, con bordo extra alto per non far traboccare i liquidi | *Silikone, tåler opvaskemaskine, pladsbesparende, kan klappes sammen, med ekstra høj kant for at beskytte mod væsker*

transparent | transparent | transparent | transparente | trasparente | transparent

69006

anthrazit | anthracite | anthracite | anthracita | anthracite | antracit

69007





faltbar
foldable

I
50 x 30 cm

IIII
2 Stck. | pcs.



 48 x 30 cm
  2 Stck. | pcs.

Napfunterlagen

*Food bowl bases | Set de table pour accueillir une gamelle |
 Bandeja para platos de mascotas | Sottociotole | Skålunderlag*

Silikon, spülmaschinengeeignet, mit extra hohem Rand um Flüssigkeiten aufzuhalten | *Silicone, dishwasher-safe, with extra high rim to keep fluids from spilling* | Silicone, lavable au lave-vaisselle, avec rebord particulièrement haut pour retenir les liquides | *Silicona, seguro para el lavavajillas, con bordes más altos para mantener los líquidos* | Silicone, lavabile in lavastoviglie, con bordo extra alto per non far traboccare i liquidi | *Silikone, tåler opvaskemaskine, med ekstra høj kant for at beskytte mod væsker*

1: Mayfair

204868 

2: Chester

204880 

3: Kington

204892 

4: Luton

204904 

5: Aarhus

64470 

6: Biri

68663 





Napfunterlage SELECTION

Food bowl base | Set de table pour accueillir une gamelle | Bandeja para platos de mascotas | Sottociotole | Skålunderlag

Silikon, spülmaschinengeeignet, mit extra hohem Rand um Flüssigkeiten aufzuhalten | *Silicone, dishwasher-safe, with extra high rim to keep fluids from spilling* | Silicone, lavable au lave-vaisselle, avec rebord particulièrement haut pour retenir les liquides | *Silicona, seguro para el lavavajillas, con bordes más altos para mantener los líquidos* | Silicone, lavabile in lavastoviglie, con bordo extra alto per non far traboccare i liquidi | *Silikone, tåler opvaskemaskine, med ekstra høj kant for at beskytte mod væsker*

transparent | transparent | transparent | transparente | trasparente | transparent

S 61410  M 62390 

creme | cream | crème | crema | crema | creme

S 69567 

khaki | kaki | kaki | caqui | cachi | kaki



S 69568 

taupe

S 69566 

schwarz | black | noir | negro | nero | sort

S 64503  M 64504 

		
S	48 x 30 cm	2 Stck. pcs.
M	60 x 40 cm	2 Stck. pcs.





■ i ||||
48 x 30 cm 2 Stck. | pcs.



■ i
48 x 30 cm

Napfunterlage EIBY

Food bowl base | Set de table pour accueillir une gamelle | Bandeja para platos de mascotas | Sottociotole | Skålunderlag

Silikon, spülmaschinengeeignet, mit extra hohem Rand um Flüssigkeiten aufzuhalten | *Silicone, dishwasher-safe, with extra high rim to keep fluids from spilling* | Silicone, lavable au lave-vaisselle, avec rebord particulièrement haut pour retenir les liquides | *Silicona, seguro para el lavavajillas, con bordes más altos para mantener los líquidos* | Silicone, lavabile in lavastoviglie, con bordo extra alto per non far traboccare i liquidi | *Silikone, tåler opvaskemaskine, med ekstra høj kant for at beskytte mod væsker*

gelb | yellow | jaune | amarillo | giallo | gul

68646 

blau | blue | bleu | azul | blu | blå

68645 

grau | grey | gris | gris | grigio | grå

68647 

Napfunterlage FC BAYERN MÜNCHEN

Food bowl base | Set de table pour accueillir une gamelle | Bandeja para platos de mascotas | Sottociotole | Skålunderlag

Silikon, spülmaschinengeeignet, mit extra hohem Rand um Flüssigkeiten aufzuhalten | *Silicone, dishwasher-safe, with extra high rim to keep fluids from spilling* | Silicone, lavable au lave-vaisselle, avec rebord particulièrement haut pour retenir les liquides | *Silicona, seguro para el lavavajillas, con bordes más altos para mantener los líquidos* | Silicone, lavabile in lavastoviglie, con bordo extra alto per non far traboccare i liquidi | *Silikone, tåler opvaskemaskine, med ekstra høj kant for at beskytte mod væsker*

FC Bayern München

69240 

BVB

68576 



■ 25 x 10 cm IIII 2 Stck. | pcs.

Reisenapf ROAD REFRESHER™

Travel bowl | Écuelle de voyage | Comedero de viaje | Ciotola da viaggio | Rejsefoderskål

Kunststoff, für Zuhause und unterwegs, dank integrierter Einlage auch während der Autofahrt kein Verschütten des Wassers | *Plastic, can be used at home and outdoor, no water spillage, even during a car journey, thanks to the integrated insert* | Plastique, à la maison et en déplacement, un élément incorporé permet de ne pas renverser d'eau en cours de trajet | *Plástico, tanto para la casa como para la calle, gracias al depósito integrado, no se derramará ni una gota de agua ni siquiera cuando el vehículo esté en movimiento* | Plastica, per l'utilizzo sia in casa che fuori casa, grazie al supporto integrato è possibile evitare la fuoriuscita dell'acqua durante il viaggio in macchina | *Kunststof, til derhjemme og undervejs, takket vare integreret indlæg, så forekommer der heller ikke under bilkørslen vandspild*

1,4 l 44442 

➔ **für unterwegs mit Anti-Schwapp-Funktion**
for travelling with anti-sloshing function

➔ **während der Fahrt nutzbar**
useable during the journey

➔ **Klettvorrichtung am Napfboden**
Velcro at the bottom of the bowl

➔ **einfach auseinander- und zusammensteckbar**
easy to take apart and put together

Der Reisenapf ROAD REFRESHER™ ermöglicht die optimale Versorgung des Hundes mit Wasser unterwegs und auf Reisen – auch während der Fahrt. Durch die ideale Form und die besondere Konstruktion des Napfes kann dieser mit Wasser gefüllt und im Fahrzeug ohne Risiko hingestellt werden, sodass das Tier jederzeit trinken kann. Eine integrierte Platte im Napf sorgt dafür, dass das Wasser auch bei Bewegung des Napfes nicht verschüttet wird. Zudem sorgen Klettverschlüsse an der Unterseite für einen stabilen Halt des Napfes. Der Reisenapf ROAD REFRESHER™ kann einfach auseinander- und wieder zusammengesteckt werden, sodass einer gründlichen Reinigung nichts im Wege steht. **Tipp: Der Reisenapf ist auch ideal für Zuhause geeignet, um unnötige Wasserpfützen um den Trinknapf herum zu vermeiden.**

The Hunter travel bowl ROAD REFRESHER™ enables you to keep your pet ideally supplied with water when you are on the move – even during travelling. Due to its ideal shape and the special construction, the bowl can be filled with water and then safely placed within the vehicle so your pet can drink whenever it wants. An integrated layer ensures that no water is spilled even when the bowl moves. In addition, the velcro on the underside provides a stable stop for the bowl on carpet or in the boot. The travel bowl ROAD REFRESHER™ unit comes apart easily and quickly clicks back together, so that it is simple to clean it. Tip: The Travel Bowl is also ideally suited for use at home in order to avoid water being spilled around the bowl.







Yummy ...

Unser Snacksortiment wurde in Deutschland entwickelt und produziert für Feinschmecker und für die, die auf gesunde Ernährung achten. Getreidefrei und ohne Zuckerzusatz, mit einer einzelnen Proteinquelle und sooo lecker! Egal ob aus purem Fleisch, mit leckeren Zutaten wie Karotten, Beeren oder Kartoffeln oder auch für den sensiblen Magen – hier ist für jeden Geschmack etwas dabei.

Our snack range was developed and produced in Germany for food lovers who want to pay attention to healthy nutrition. Cereal and no added sugar, with an individual source of protein and sooo yummy! Whether its pure meat with tasty additions like carrots, berries or potatoes, or even for the sensitive stomach – this range has something for every taste.



75 g 12/Tray

Hundesnack REAL

Reward | Récompense | Recompensa | Snack per cani | Hundesnack

aus frischem Fleisch, eine tierische Proteinquelle, getreidefrei, ohne Zuckerzusatz, gesunder Snack zwischen den Mahlzeiten, Made in Germany | *made using fresh meat, one source of animal protein, grain-free, no added sugar, healthy snack between meals, Made in Germany* | à base de viande fraîche et d'une source de protéines animales, ne contient ni céréale, sans sucre ajouté, friandise saine entre les repas, Made in Germany | *a partir de carne fresca, una fuente de proteína animal, sin cereales, sin azúcar añadida, snack saludable para comer entre horas, Made in Germany* | in carne fresca, una fonte di proteine animali, senza cereali, senza zuccheri aggiunti, sano snack tra un pasto e l'altro, Made in Germany | *af fersk kød, en animalsk proteinkilde, kornfrit, ikke tilsat sukker, sund snack mellem måltiderne, Made in Germany*

1: Huhn | Chicken | Poulet | Pollo | Pollo | Kylling

65780

2: Rind | Beef | Bœuf | Vacuno | Bovino | Okse

65783



80 g 12/Tray

Hundesnack REAL STICKS

Reward | Récompense | Recompensa | Snack per cani | Hundesnack

aus frischem Fleisch, eine tierische Proteinquelle, getreidefrei, ohne Zuckerzusatz, gesunder Snack zwischen den Mahlzeiten, Made in Germany | *made using fresh meat, one source of animal protein, grain-free, no added sugar, healthy snack between meals, Made in Germany* | à base de viande fraîche, à base de protéines animales, ne contient ni céréale, sans sucre ajouté, friandise saine entre les repas, Made in Germany | *a partir de carne fresca, una fuente de proteína animal, sin cereales, sin azúcar añadida, snack saludable para comer entre horas, Made in Germany* | in carne fresca, una fonte di proteine animali, senza cereali, senza zuccheri aggiunti, sano snack tra un pasto e l'altro, Made in Germany | *af fersk kød, en animalsk proteinkilde, kornfrit, ikke tilsat sukker, sund snack mellem måltiderne, Made in Germany*

1: Huhn | Chicken | Poulet | Pollo | Pollo | Kylling

65786

2: Rind | Beef | Bœuf | Vacuno | Bovino | Okse

65787



✓ getreidefrei *grainfree*
 ✓ ohne Zuckerzusatz
 ✓ eine tierische Proteinquelle
single animal protein





75 g 12/Tray

Hundesnack MAXIS

Reward | Récompense | Recompensa | Snack per cani | Hundesnack | Maxis hondensnack

aus frischem Fleisch, extra groß, eine tierische Proteinquelle, getreidefrei, ohne Zuckerzusatz, gesunder Snack zwischen den Mahlzeiten, Made in Germany | *made using fresh meat, extra large, one source of animal protein, grain-free, no added sugar, healthy snack between meals, Made in Germany* | à base de viande fraîche, très grande, à base de protéines animales, ne contient ni céréale, sans sucre ajouté, friandise saine entre les repas, Made in Germany | *a partir de carne fresca, extra-grande, una fuente de proteína animal, sin cereales, sin azúcar añadida, snack saludable para comer entre horas, Made in Germany* | in carne fresca, extra grande, una fonte di proteine animali, senza cereali, senza zuccheri aggiunti, sano snack tra un pasto e l'altro, Made in Germany | *af fersk kød, ekstra stort, en animalsk proteinkilde, kornfrit, ikke tilsat sukker, sund snack mellem måltiderne, Made in Germany* | De NATURE REAL-hondensnack is de ideale beloning voor tussen de maaltijden door. De grote kauwstrips smaken niet alleen heerlijk, maar zijn ook graanvrij, hebben geen toegevoegde suikers en bevatten slechts één dierlijke eiwitbron. Het onafhankelijke testportaal futtertester.de gaf de NATURE REAL het testresultaat "Zeer goed" met 9,6 van 10 sterren. Let op: Als tussendoortje naast de dagelijkse maaltijden. Er moet altijd een bakje vers water klaar staan. Laat uw huisdier nooit zonder toezicht achter met een kauwproduct.

1: Huhn | Chicken | Poulet | Pollo | Pollo | Kylling

65784

2: Rind | Beef | Bœuf | Vacuno | Bovino | Okse

65785





#	📦	🏠	
65792	70 g	Rind mit Rote Beete <i>Beef with beetroot</i>	12/Tray
65793	70 g	Huhn mit Blaubeere & Preiselbeere <i>Chicken with blueberry & cranberry</i>	12/Tray
65795	70 g	100 % Huhn <i>100 % Chicken</i>	12/Tray
65794	70 g	Kartoffeln mit Petersilie & Leinsamen <i>Potato with parsley & linseed</i>	12/Tray

Hundesnack LIFESTYLE

Reward | Récompense | Recompensa | Snack per cani | Hundesnack

mit leckeren Zutaten, ansprechende Herzform, eine tierische Proteinquelle, getreidefrei, ohne Zuckerzusatz, gesunder Snack zwischen den Mahlzeiten, Made in Germany | *with delicious ingredients, appealing heart shape, one source of animal protein, grain-free, no added sugar, healthy snack between meals, Made in Germany* | avec de délicieux ingrédients, en forme de coeur attrayante, à base de protéines animales, ne contient ni céréale, sans sucre ajouté, friandise saine entre les repas, Made in Germany | *con deliciosos ingredientes, original forma de corazón, una fuente de proteína animal, sin cereales, sin azúcar añadida, snack saludable para comer entre horas, Made in Germany* | con deliziosi ingredienti, accattivante forma a cuore, una fonte di proteine animali, senza cereali, senza zuccheri aggiunti, sano snack tra un pasto e l'altro, made in Germany | *med lækre ingredienser, sød hjerteform, en animalsk proteinkilde, kornfrit, ikke tilsat sukker, sund snack mellem måltiderne, Made in Germany*

1: Omas Küche | Grandma's kitchen | La cuisine de grand-mère | La cocina de la abuela | La cucina della nonna | Bedstemors køkken

65792

2: Mit Liebe gemacht | Made with love | Préparé avec amour | Hecho con cariño | Fatto con amore | Lavet med kærlighed

65793

3: Auf dem Bauernhof | Down on the farm | À la ferme | En la granja | In fattoria | På bondegården

65795

4: Veggie Bites

65794





#	📦	🐕	
65788	70 g	Huhn mit Quinoa <i>Chicken with quinoa</i>	12/Tray
65790	70 g	Rind mit Karotten und Kräutern <i>Beef with carrots and herbs</i>	12/Tray
65791	70 g	Huhn und Zucchini <i>Chicken with Courgette</i>	12/Tray

Hundesnack TRAINING

Reward | Récompense | Recompensa | Snack per cani | Hundesnack

mit leckeren Zutaten, ideal für Training & Ausbildung, eine tierische Proteinquelle, getreidefrei, ohne Zuckerzusatz, gesunder Snack zwischen den Mahlzeiten, Made in Germany | *with delicious ingredients, ideal for training, one source of animal protein, grain-free, no added sugar, healthy snack between meals, Made in Germany* | avec de délicieux ingrédients, idéal pour l'entraînement et le dressage à base de protéines animales, ne contient ni céréale, sans sucre ajouté, friandise saine entre les repas, Made in Germany | *con deliciosos ingredientes, ideal para entrenamientos y formación, una fuente de proteína animal, sin cereales, sin azúcar añadida, snack saludable para comer entre horas, Made in Germany* | con deliziosi ingredienti, ideali per l'addestramento e formazione, una fonte di proteine animali, senza cereali, senza zuccheri aggiunti, sano snack tra un pasto e l'altro, Made in Germany | *med lekre ingredienser, ideelt til træning & uddannelse, en animalsk proteinkilde, kornfrit, ikke tilsat sukker, sund snack mellem måltiderne, Made in Germany*

1: Supersportler | Super athlete | Super sportif | Moto deportiva | Super atleta | Superatlet

65788

2: Sensitiv | Sensitive | Sensitif | Sensible | Delicato | Følsom

65790

3: Low Fat

65791



EXTRA
KLEINE SNACKS
especially small snacks

Ideal für Training & Ausbildung
ideal for training





III	II	I	IIII
Toffee	200 g	mit Geflügel with poultry	14/Tray
Duo Bones	200 g	mit Reis with rice	14/Tray
Rollo	200 g	mit Wild with venison	14/Tray
Multi Bone	200 g	mit Lachs with salmon	14/Tray
Konfekt	200 g	mit Geflügel with poultry	14/Tray
Roma	200 g	mit Truthahn with turkey	14/Tray

EXTRA
KLEINE SNACKS
especially small snacks

Ideal für Training & Ausbildung
ideal for training

Hundesnack TRAINING

Reward | Récompense | Ricompensa | Snack per cani | Hundesnack

Getreide/pflanzliche Nebenerzeugnisse/Fleisch/tierische Neben-
erzeugnisse, ohne Salz- und Zuckerzusatz, kleine Happen – ideal für
Hundetraining und -ausbildung | *cereals, vegetable by-products, meat
and animal by-products, no added salt or sugar, small bites - ideal for
dog training and education* | Céréales/sous-produits végétaux/viande/
sous-produits animaux, sans sel ni sucre ajouté, petites bouchées - idéal
pour le dressage et l'éducation des chiens | *Cereales/subproductos de
plantas/carne/subproductos animales, sin sal o azúcar añadidos, mordiscos
pequeños - ideal para el entrenamiento y la educación del perro* | Cereali/
sottoprodotti vegetali/carne/sottoprodotti animali, senza aggiunta di
sale o zucchero, piccoli morsi - ideale per l'addestramento e l'educa-
zione dei cani | *Korn/vegetabiliske biprodukter/kød/animalske biprodukter
uden tilsat salt eller sukker, små bid - ideel til hundetræning og uddannelse*

1: Toffee

45400

2: Duo Bones

45403

3: Rollo

45404

4: Multi Bone

45402

5: Konfekt

45401

6: Roma

45405





Hundesnack TASTY TOOTH BONE

Reward | Récompense | Recompensa | Snack per cani | Hundesnack

ideal als Kau-Snack, kann bei der Zahnreinigung unterstützen, kann den Atem erfrischen | *ideal as a chewing snack, can help to clean teeth, can freshen breath* | idéal comme en-cas à mâcher, peut aider à nettoyer les dents, peut rafraîchir l'haleine | *ideal como aperitivo para masticar, complementa la limpieza dental, puede refrescar el aliento* | ideale come spuntino da masticare, può aiutare nella pulizia dei denti, può rinfrescare l'aito | *ideel som tygge snack, kan understøtte tandrensning, kan give friskere ånde*

44401 

35 g 24/Tray



Hundesnack SPIKE BONE

Reward | Récompense | Recompensa | Snack per cani | Hundesnack

ohne künstliche Geschmacks- oder Farbstoffe, mit Minze, kann bei der Zahnreinigung unterstützen, kann den Atem erfrischen | *no artificial colours or flavours, with mint, can help to clean teeth, can freshen breath* | sans colorantes ou de goûts artificiels, avec menthe, peut aider à nettoyer les dents, peut rafraîchir l'haleine | *sin colorantes o de gusto artificiales, con menta, complementa la limpieza dental, puede refrescar el aliento* | non contiene aromi e coloranti artificiali, con menta, può aiutare nella pulizia dei denti, può rinfrescare l'aito | *uden kunstige smags- og farvestoffer, med mynte, kan understøtte tandrensning, kan give friskere ånde*

44412 

68 g 12/Tray | 4/Beutel | bag



Hundesnack PEPPERMINT SNACK

Reward | Récompense | Recompensa | Snack per cani | Hundesnack

ohne künstliche Geschmacks- oder Farbstoffe, mit Minze, kann bei der Zahnreinigung unterstützen, kann den Atem erfrischen | *no artificial colours or flavours, with mint, can help to clean teeth, can freshen breath* | sans colorantes ou de goûts artificiels, avec menthe, peut aider à nettoyer les dents, peut rafraîchir l'haleine | *sin colorantes o de gusto artificiales, con menta, complementa la limpieza dental, puede refrescar el aliento* | non contiene aromi e coloranti artificiali, con menta, può aiutare nella pulizia dei denti, può rinfrescare l'aito | *uden kunstige smags- og farvestoffer, med mynte, kan understøtte tandrensning, kan give friskere ånde-*

43617 

90 g 12/Tray | 5/Beutel | bag



90 g 12/Tray | 10/Beutel | bag

Hundesnack MINI CALCIUM MILK BONE

Reward | Récompense | Recompensa | Snack per cani | Hundesnack

mit Calcium, Zell- und Yuccafasern, die das Verdauungssystem und die Zahngesundheit des Hundes unterstützen können, kann den Atem erfrischen, für Welpen und Kleinhunde geeignet | *with calcium, cell and yucca fibers, which help the digestive system and the oral health of dogs, can freshen breath, suitable for puppies and small dogs* | contient du calcium, des fibres cellulaires et de yucca qui participent à la protection du système digestif des chiens ainsi que de leurs dents, donne une haleine fraîche, convient aux chiots et aux petits chiens | *con calcio, fibras celulares y de yuca; ayuda a cuidar el sistema digestivo y la salud dental del perro; refresca el aliento; adecuado para cachorros y razas pequeñas* | con calcio, fibre cellulari e yucca, che possono aiutare il sistema digestivo e la salute dentale del cane, rinfresca l'alito, adatto ai cuccioli e ai cani piccoli | *med calcium, celle- og yuccafibre, der understøtter hundens fordøjelsessystem og tandsundhed, giver friskere ånde, egnet til hvalpe og mindre hunde*

61037



S 23 g 36/Tray | 1/Beutel | bag
M 54 g 24/Tray | 1/Beutel | bag

Hundesnack CALCIUM MILK BONE

Reward | Récompense | Recompensa | Snack per cani | Hundesnack

mit Calcium, Zell- und Yuccafasern, die das Verdauungssystem und die Zahngesundheit des Hundes unterstützen können, kann den Atem erfrischen | *with calcium, cell and yucca fibers, which help the digestive system and the oral health of dogs, can freshen breath* | contient du calcium, des fibres cellulaires et de yucca qui participent à la protection du système digestif des chiens ainsi que de leurs dents, donne une haleine fraîche | *con calcio, fibras celulares y de yuca, ayuda a cuidar el sistema digestivo y la salud dental del perro, refresca el aliento* | con calcio, fibre cellulari e yucca, che possono aiutare il sistema digestivo e la salute dentale del cane, rinfresca l'alito | *med calcium, celle- og yuccafibre, der understøtter hundens fordøjelsessystem og tandsundhed, giver friskere ånde*

S 44397 M 44398





Hundesnack SEAWEED BONES

Reward | Récompense | Recompensa | Snack per cani | Hundesnack

Meeresalgen enthalten Zink, Vitamine und Chlorophyll, wodurch der Stoffwechsel angeregt werden kann, kann bei der Zahnreinigung unterstützen, kann den Atem erfrischen | *Seaweed contains zinc, vitamins and chlorophyll, which can stimulate metabolism, can help to clean teeth, can freshen breath* | les algues marines contiennent du zinc, des vitamines et de la chlorophylle, qui stimulent le métabolisme, peut aider à nettoyer les dents, peut rafraîchir l'haleine | *las algas marinas contienen zinc, vitaminas y clorofila que estimulan el metabolismo, complementa la limpieza dental, puede refrescar el aliento* | le alghe marine contengono zinco, vitamine e clorofilla, attraverso le quali può essere stimolato il metabolismo, può aiutare nella pulizia dei denti, può rinfrescare l'alito | *Havalger indeholder zink, vitaminer og klorofyl, der fremmer stoffskiftet, kan understøtte tandrensning, kan give friskere ånde*

44395 

 200 g  3 Stck. | pcs.





100%
natürlich
natural

III
6 Stck. | pcs.



Qualität aus NORWEGEN
Quality made in NORWAY

Lachs-Öl für Hunde

Salmon oil for dogs | Huile de saumon pour chiens | Aceite de salmón para perros | Olio di salmone per cani | Lakseolie til hunde

reines Lachsöl, reich an wertvollen Omega-3 Fettsäuren, Einzelfuttermittel - für den täglichen Gebrauch geeignet, einfach unter das Futter mischen | *pure salmon oil, with important Omega 3 fatty acids, single food - suitable for daily use, simply mix with food* | huile de saumon, avec acides gras Oméga 3 compléments alimentaires, alimentation unique - adaptée à un usage quotidien, mélanger avec les aliments | *aceite de salmón natural, con ácidos grasos Omega 3, alimento único - adecuado para el uso diario, como aliciente a las comidas diarias* | Olio di salmone puro, ricco di preziosi acidi grassi Omega 3, alimentazione singola - adatto per l'uso quotidiano, mescolare semplicemente al mangime | *ren lakseolie, stort indhold af værdifulde omega-3 fedtsyrer, enkeltfoder - velegnet til daglig brug, blandes i foderet*

for dogs

500 ml 44419

for cats

250 ml 44420

HUNTER Lachs-Öl wird hergestellt aus nachhaltig gezüchteten Lachsen, die in ursprünglichen norwegischen Fjord-Gewässern beheimatet sind. Durch die unmittelbar nach dem Fang stattfindende Öl-Extraktion handelt es sich um ein äußerst frisches Öl, welches sich durch eine ausgezeichnete und naturbelassene Qualität auszeichnet - ohne chemische Raffination und ohne synthetische Modifizierung. Aufgrund der schonenden Verarbeitung bietet HUNTER Lachs-Öl eine ganzheitliche Versorgung Ihres Tieres: alle essentiellen Omega-3 Fettsäuren sind enthalten und darüber hinaus Vitamin A und Vitamin D sowie das natürliche und hochwirksame Antioxidans Astaxanthin, welches für die typische ‚Lachsfarbe‘ des Öls verantwortlich ist. HUNTER Lachs-Öl enthält keinerlei Zusatzstoffe und wird zu 100% aus norwegischem Lachs hergestellt. Durch eine mit Stickstoff geschützte Abfüllung in hochwertige Metallflaschen ist HUNTER Lachs-Öl optimal vor der Entstehung schädlicher Oxidationsprodukte im Öl geschützt und bietet eine ausgezeichnete Haltbarkeit von 2 Jahren bei Raumtemperatur.

HUNTER salmon oil is derived from sustainably farmed salmon from their native habitat in the Norwegian fjords. Because it is extracted immediately after the salmon is caught, the oil is extremely fresh and characterized by an excellent, natural quality - no chemical refining or synthetic modification necessary. Due to the gentle processing, HUNTER salmon oil provides comprehensive nutrition for your pet: it contains all essential Omega-3 fatty acids, as well as Vitamin A and Vitamin D and the natural and highly effective antioxidant Astaxanthin, which provides the typical ‚salmon coloring‘ of the oil. HUNTER salmon oil does not contain any additives and is made from 100% Norwegian salmon. Thanks to the nitrogen-protected bottling process using high-quality metal bottles, HUNTER salmon oil is perfectly protected against harmful oxidation products and has an excellent shelf life of 2 years at room temperature.



<p>Ultra-frisches Lachsöl, unter einer Schutzgasatmosphäre abgefüllt → 2 Jahre Haltbarkeit bei Raumtemperatur <i>Ultra-fresh salmon oil, bottled in a protective atmosphere → Shelf life of 2 years at room temperature</i></p>	<p>✓</p>
<p>Alle relevanten Omega-3 Fettsäuren → kann positive Effekte auf das Herzkreislauf-System und das Fell haben <i>All important Omega-3 fatty acids → can have positive impact on cardiovascular system and coat</i></p>	<p>✓</p>
<p>Natürliches Antioxidans Astaxanthin + Vitamin A und D → Umfassende Nährstoffversorgung <i>Natural antioxidant Astaxanthin + Vitamin A and D → Comprehensive nutrient supply</i></p>	<p>✓</p>
<p>Schonende Extraktion bei niedriger Temperatur → Optimale Produktqualität <i>Gentle extraction at low temperatures → Optimum product quality</i></p>	<p>✓</p>
<p>Nachhaltige Zucht, vollständige Rückverfolgbarkeit → Erhöhte Produktsicherheit <i>Sustainable farming, full traceability → Enhanced product safety</i></p>	<p>✓</p>
<p>Niedrigste Oxidations- und Kontaminantenwerte → Kein schädlicher Fettverderb <i>Lowest oxidation and contaminant values → No harmful fat degradation</i></p>	<p>✓</p>
<p>Keine Raffination notwendig → Nährstoffe bleiben erhalten und werden nicht heraus gefiltert <i>No refining processes necessary → Nutrients remain intact and are not removed by filtering</i></p>	<p>✓</p>



Pflege & Hygiene

Care & Hygiene

Hunde bedürfen der regelmäßigen Pflege durch Ihre Besitzer und erfreuen sich dabei der liebevollen Zuwendung. Gleichsam wirkungsvolle und schonend-sanfte Produkte sorgen für glänzendes Fell, gesunde Haut und allgemeines Wohlbefinden.

Dogs need regular care from their owners and enjoy this physical affection. Our effective and gentle products ensure a shiny coat, healthy skin and overall well-being.





III
3 Stck. | pcs.

Pflegekamm SPA

Grooming comb | Peigne de soin | Peine de cuidados | Pettine per toelettatura | Plejekam

zur Pflege von Deckhaar und Unterwolle, löst Verknötungen, entfernt totes Haar, Schmutz und Ungeziefer, Zinken aus hochwertigem Edelstahl, ergonomisch geformter Griff in Lederoptik für rutschfeste und angenehme Handhabung | for looking after topcoats and undercoats, loosens knots, removes dead hair, dirt and pests, teeth made of high-quality stainless steel, ergonomically designed handle in leather look for non-slip and comfortable handling | pour soigner le poil de couverture et le sous-poil, démêle les noeuds, élimine les poils morts, la saleté et la vermine, dents en inox de grande qualité, poignée antidérapante de forme ergonomique en similicuir pour un maniement agréable | para cuidar el pelo de cobertura y el subpelo, elimina nudos, retira el pelo muerto, la suciedad y posibles parásitos, púas de acero inoxidable de gran calidad, mango ergonómico de imitación al cuero para un manejo cómodo y antideslizante | per la cura del pelo di copertura e del sottopelo, allenta i nodi, rimuove il pelo morto, la sporcizia e gli insetti nocivi, denti in pregiato acciaio inox, l'impugnatura ergonomica in similpelle per una presa antiscivolo e piacevole | til pleje af dekhår og underuld, løsner knuder, fjerner dødt hår, snavs og utøj, tænder af eksklusiv rustfrit stål, ergonomisk formet greb i læderlook for en skridsikker og behagelig håndtering

1: Pflegekamm mit rotierenden Zinken | Grooming comb/rotating teeth | Peigne de soin/dents rotatives | Peine de cuidados/púas rotatorias | Pettine per toelettatura/denti rotanti | Plejekam/roterende tænder

19 x 4 cm 65582  21 x 4 cm 65580 

2: Pflegekamm mit langen und kurzen Zinken | Grooming comb/long and short teeth | Peigne de soin/dents longues et courtes | Peine de cuidados/púas largas y cortas | Pettine per toelettatura/denti lunghi e corti | Plejekam/lange og korte tænder

21 x 4 cm 65581 

3: Floh- und Nissenkamm | Flea and nit comb | Peigne anti-poux et lentes | Cepillo para pulgas y liendres | Pettine antipulci e pidocchi | Loppe- og lusekam

7 x 6 cm 65584 





Pflegemesser SPA

Grooming knife | *Lame de soin* | *Cuchilla de cuidados* | *Rasoio per toelettatura* | *Plejekniv*

zum Entfernen von losem Oberfell bzw. zum Lösen von Verfilzungen der Unterwolle | *for removing loose outer hairs or tangles in the undercoat* | *pour éliminer les poils de couverture morts et démêler les noeuds du sous-poil* | *para retirar el pelo de cobertura suelto y eliminar enredos en el subpelo* | *per rimuovere il pelo morto esterno o per eliminare l'infeltrimento del sottopelo* | *til fjernelse af løst dækhår hhv. til at løsne sammenfiltringer i underulden*

1: Entfilzungsmesser | Dematting knife | *Lame de démêlage* | *Rastrillo desenredante* | *Slanatore* | *Filterkniv*

18 cm 65575

2: Trimmmesser, sichelförmig | Stripping knife, crescent-shaped | *Peigne-rasoir/falqué* | *Cuchilla para stripping/media luna* | *Taglianodi/falciforme* | *Trimmekniv/halvmåneformet*

fine 65577

3: Trimmmesser gebogen | Stripping knife curved | *Peigne-rasoir/courbé* | *Cuchilla para stripping curva* | *Taglianodi curvo* | *Trimmekniv bøjet*

single 65578 double 65579

III
3 Stck. | pcs.

Krallenpflege SPA

Nail care | *Soin de griffes* | *Cuidados de uñas* | *Cura della zampe* | *Neglepleje*

zum präzisen Kürzen der Krallen von Hunden und Katzen bei geringem Kraftaufwand | *for precision shortening of dogs' and cats' claws with minimal effort* | *pour couper sans effort les griffes des chiens et des chats avec précision* | *para cortar las uñas de perros y gatos con precisión y poco esfuerzo* | *per accorciare con precisione le unghie di cani e gatti con poco sforzo* | *til præcis afkortning af kløer hos hunde og katte med minimal kraft*

1: Krallenschere | Nail scissors | *Coupe-griffes* | *Tijera cortaúñas* | *Forbici per zampe* | *Neglesaks*

9,5 cm 65586 14,5 cm 65585

2: Krallenzange | Nail clippers | *Coupe-griffes* | *Pinza cortaúñas* | *Tronchesino per zampe* | *Negletang*

12,5 cm 65588 16,0 cm 65589

III
3 Stck. | pcs.



Pflegebürste SPA

Grooming brush | Brosse de soin | Cepillo de cuidados | Spazzola per toelettatura | Plejebørste

1: Pflegebürste | Grooming brush | Brosse de soin | Cepillo de cuidados | Spazzola per toelettatura | Plejebørste

21 cm 65554  22 cm 65553 



2: Pflegebürste Extra Soft | Grooming brush Extra Soft | Brosse de soin Extra Soft | Cepillo de cuidados Extra Soft | Spazzola per toelettatura Extra Soft | Plejebørste Extra Soft

19 cm 65555 

3: Pflegebürste, selbstreinigend | Grooming brush, self-cleaning | Brosse de soin, autonettoyante | Cepillo de cuidados, autolimpiable | Spazzola per toelettatura, autopulente | Plejebørste, selvrensende

19 cm 65557  22 cm 65556 

4: Zupfbürste, selbstreinigend | Plucking brush, self-cleaning | Brosse dépilatoire, autonettoyante | Cepillo para cardar, autolimpiable | Cardatore, autopulente | Napbørste, selvrensende

16 cm 65563  17 cm 65558 

19 cm 65559 

5: Kombibürste »Bürsten und Pflegen« | Multi-purpose brush »Brushing and grooming« | Brosse combinée »Brossage et entretien« | Cepillo combinado »Cepillado y cuidado« | Spazzola combinata »Spazzolare e curare« | Kombibørste »Børstning og pleje«

21 cm 65552  22 cm 65551 

6: Kombibürste »Zupfen und Kämmen« | Multi-purpose brush »Plucking and combing« | Brosse combinée »Épilation et peigne« | Cepillo combinado »Cardar y peinar« | Spazzola combinata »Cardare e pettinare« | Kombibørste »Napning og børstning«

18 cm 65560  20 cm 65561 

22 cm 65562 

III
3 Stck. | pcs.



Pflegestriegel SPA

Curry comb | Étrille de soin | Peine de curry de cuidados | Striglia per toelettatura | Plejestrigle

zum Entfernen von losem Haar und Schuppen aus Deck- und Unterwolle | *for removing loose hair and dander from undercoats and guard hairs* | pour éliminer les poils morts et les pellicules du poil de couverture et du sous-poil | *para retirar el pelo suelto y escamar el pelo de cobertura y el subpelo* | per rimuovere il pelo morto e la forfora da pelo di copertura e sottopelo | *til fjernelse af løse hår og skæld i dekhåret og i underulden*

1: Entwirrungsstriegel, selbstreinigend | Detangling rake, self-cleaning | Étrille démêlante, autonettoyante | Peine de curry antienredos, autolimpiable | Rastrello districante, autopulente | Udredningsstrigle, selvrensende

17 x 11 cm **65564** 

2: Entwirrungsstriegel, zweireihig | Detangling rake, double row | Étrille démêlante, deux rangées | Peine de curry antienredos, dos filas | Rastrello districante, a due file | Udredningsstrigle, dobbeltraded

16 x 11 cm **65566** 

3: Pflegestriegel mit integr. Shampoofunktion | Curry comb, shampooing function | Étrille de soin, fonction shampooing | Peine de curry de cuidados, función champú | Striglia per toelettatura, Funzione shampoo | Plejestrigle, shampoofunktion

12 x 8 cm **65568** 

4: Trimmstriegel mit Edelstahlklinge | Stripping rake with stainless steel blade | Déméloir de toiletteage, lame en inox | Peine rastrillo, cuchilla de acero | Slanatore, Lama in acciaio inox | Trimmestrigle, klinge i rustfrit stål

16 x 7 cm **65570**  16 x 9 cm **65571** 

5: Trimmstriegel Spezialklinge | Stripping rake special blade | Étrille-rasoir, lame spéciale | Peine de curry para stripping, cuchilla especial | Striglia taglianodi, lama speciale | Trimmestrigle, specialblad

18 x 6 cm **65572**  18 x 8 cm **65573** 

18 x 10 cm **65574** 

6: Pflegehandschuh | Care glove | Gants de soin | Guante de cepillado | Guanto per la cura | Plejehandske

23 x 17 cm **66838** 

III
3 Stck. | pcs.



■ i IIII
16 x 18 cm 3 Stck. | pcs.

Wellness Handschuh

Wellness glove | Gant Wellness | Guante wellness | Guanto benessere | Wellness-handske

Vollgummi, mit Noppen | *Rubber, with neps* | Caoutchouc, avec noppes | *Goma, con protuberancia* | Gomma piena, con nodi | *Gummi, med nopret*

97983 

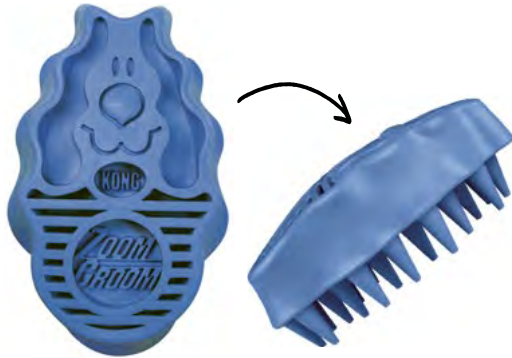

■ i IIII
12 x 7 cm 3 Stck. | pcs.

Striegel für Hunde

KONG® ZOOMGROOM™

Curry-comb for dogs | Etrille pour chiens | Almohazas para perros | Striglia per cani | Strigle til hunde

Vollgummi, mit Noppen | *Rubber, with neps* | Caoutchouc, avec noppes | *Goma, con protuberancia* | Gomma piena, con nodi | *Gummi, med nopret*

42549 

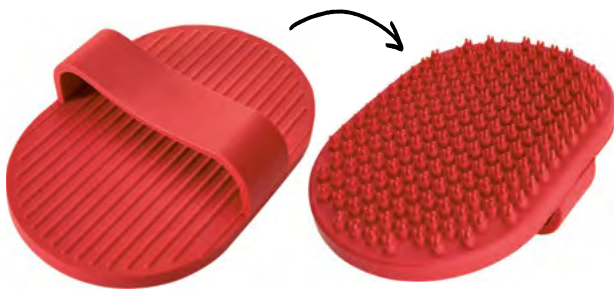

■ i IIII
8,5 x 13,0 cm 3 Stck. | pcs.

Wellness Massage Striegel

Wellness massage curry comb | Brosse de massage Wellness | Rastrillo masajeador wellness | Pettine per massaggio benessere | Wellness Massage Strigle

Vollgummi, mit Noppen | *Rubber, with neps* | Caoutchouc, avec noppes | *Goma, con protuberancia* | Gomma piena, con nodi | *Gummi, med nopret*

97949 





III
15/Display

Display Bürste MARIENKÄFER

Display Brush | Support Brosse | Soporte Cepillo | Espositore Spazzola | Display Borster

Kunststoff, Gummiborsten in V-Form, zum Entfernen von Tierhaaren an Kleidung oder Polstern durch statische Aufladung der Gummiborsten, auch zur Massage geeignet, 15 Bürsten im praktischen Display | Plastic, rubber bristles in V-shape, static charges from rubber bristles remove animal hairs on clothes or upholstery, also well suited for massages, 15 brushes in a practical display | Plastique, brosses en caoutchouc en forme de V, pour éliminer les poils d'animaux sur les vêtements ou les coussins grâce à la charge statique de la brosse en caoutchouc, également idéale pour les massages, 15 petites brosses dans un conditionnement pratique | Plástico, cerdas de goma en forma de V, para retirar el pelo de mascotas de la ropa o de tapizados por cargas estáticas de cerdas de goma, también indicado para masajear, 15 cepillos en práctico mostrador | Plastica, setole in gomma disposte a V, rimuove i peli di animali da vestiti e imbottiti grazie alla carica elettrostatica delle setole in gomma, indicato anche per massaggiare, 15 spazzole nel pratico display | Kunststof, gummiborster i V-form, til fjernelse af dyrehår på beklædning eller polstring ved hjælp af statisk opladning af gummiborster, samt egnet til massage, 15 borster i praktisk display

10 cm 44507 





1



2



3



4



5



6



Shampoo SPA

speziell für die schonende Reinigung und Pflege für Hunde | *designed specifically for gentle cleaning and care of dogs* | développé spécialement pour le nettoyage et le soin délicats des chiens | *especialmente desarrollado para la limpieza suave y el cuidado de perros* | creato apposta per una pulizia e una cura delicate per cani | *spezielt udviklet til den skånsomme rensning og pleje til hunde*

1: Basis Pflegeshampoo | Basic grooming shampoo | Shampooing traitant de base | Champú básico | Shampoo delicato base | Basis plejeshampoo

200 ml 62026

2: Welpenshampoo | Puppy shampoo | Shampooing pour chiot | Champú para cachorros | Shampoo per cuccioli | Hvalpeshampoo

200 ml 62027

3: Pflegeshampoo | Grooming shampoo | Shampooing traitant | Cuidado champú | Shampoo delicato | Plejeshampoo

200 ml 62028

4: Shampoo für weißes Fell | Shampoo for white fur | Shampooing pour pelage blanc | Champú para pelo blanco | Shampoo per pelo bianco | Shampoo til hvidt skind

200 ml 62029

5: Shampoo für schwarzes Fell | Shampoo for black fur | Shampooing pour pelage noir | Champú para pelo negro | Shampoo per pelo nero | Shampoo til sort skind

200 ml 62030

6: Feuchtigkeitsshampoo | Moisturising Shampoo | Shampooing hydratant | Champú humedad | Shampoo nutriente | Fugtighedsshampoo

200 ml 62031

IIII

6 Stck. | pcs.

mit Schwarzkümmel und Hanföl
with black cumin- & hemp oil



MADE
IN
GERMANY

III
6 Stck. | pcs.

Antijuckreiz-Spray SPA

Anti-itch spray | Spray antidémangeaisons | Spray antipicazón | Spray antiprurito | Anti-kløe spray

mit Schwarzkümmel- & Hanföl, frei von Silikonen, Mineralölen und Paraffinen, speziell auf empfindliche, juckende und gereizte Haut abgestimmte Wirkstoff-Kombination | with black cumin- & hemp oil, free of silicones, mineral oils and paraffins, combination of ingredients especially formulated for sensitive, itchy and irritated skin | au cumin noir & à huile de chanvre, exempt de silicones, d'huiles minérales et de paraffines, combinaison d'ingrédients actifs spécialement formulée pour les peaux sensibles, irritées et qui démangent | con comino negro & aceite de cáñamo, libre de siliconas, aceites minerales y parafinas, combinación de ingredientes activos especialmente formulados para la piel sensible, con picor e irritada | con nigella sativa & olio di semi di canapa, privo di siliconi, oli minerali e paraffine, combinazione di principi attivi appositamente formulati per pelli sensibili, pruriginose e irritate | med sortkommen & hampolje, fri for silikone, mineralolier og paraffiner, en kombination af aktive ingredienser specielt formuleret til følsom, kløende og irriteret hud

200 ml 62034



mit Avocado-Öl
with avocado oil

MADE
IN
GERMANY

III
6 Stck. | pcs.

Fellpflege-Spray SPA

Grooming spray | Spray de soin | Spray para el cuidado del pelo | Spray per la cura del cappotto | Skindplejespray

mit Avocado-Öl, frei von Silikonen, Mineralölen und Paraffinen, speziell auf stumpfes, trockenenes und glanzloses Fell abgestimmte Wirkstoff-Kombination | with avocado oil, free of silicones, mineral oils and paraffins, specially formulated combination of active ingredients for dull, dry and dull coat | avec de l'huile d'avocat, exempt de silicones, d'huiles minérales et de paraffines, combinaison d'ingrédients actifs spécialement adaptés au pelage terne, sec et terne | con aceite de aguacate, libre de siliconas, aceites minerales y parafinas, combinación de ingredientes activos especialmente adaptados al pelaje opaco, seco y sin brillo | con olio di avocado, privo di siliconi, oli minerali e paraffine, combinazione di principi attivi appositamente adattati per il manto opaco, secco e opaco | med avocadoolie, fri for silikone, mineralolier og paraffiner, en kombination af aktive ingredienser specielt skræddersyet til kedelig, tør og kedelig pels

200 ml 62035



MADE
IN
GERMANY

III
6 Stck. | pcs.

Pfotenpflege SPA

Paw care | Soins des pattes | Cuidado para patas | Cura delle zampe | Potepłeje

schützt bei regelmäßiger Anwendung die Pfoten vor Austrocknung und Rissen | with regular use, protects paws from drying out and cracking | utilisé régulièrement, ce produit permet de protéger les pattes du dessèchement et du fendillement | utilizado regularmente, protege las patas de la sequedad y evita que se agrieten | un regolare utilizzo protegge le zampe prevenendo tagli e pelle secca | beskytter ved regelmæssig anvendelse poterne mod udtørring og revner

75 ml 62039





24/Display



Jetzt auch in 10er-Verpackungseinheiten

Now also available in packs of 10

NEW
10x



2 Größen je Packung

2 sizes per pack

	■	■ ■ ■
Display	19 x 14 x 9 cm	24/Display – 2 Stck. pcs.
Single unit	8,5 x 13,0 cm	10 x 2 Stck. pcs.

Zeckenhaken AJKA

Tick hook | Crochet de tique | Gancho para garrapatas | Gancio di spunta | Tick-krog

Kunststoff, zum schnellen und schmerzfreien Entfernen von Zecken unterschiedlicher Größe (2 Haken), einfache Handhabung, robust und wiederverwendbar, geeignet für Tier und Mensch | Plastic, for quick and painless removal of ticks of different sizes (2 hooks), easy handling, robust and reusable, suitable for animals and humans | Plastique, pour un retrait rapide et indolore des tiques de différentes tailles (2 crochets), facile à manipuler, robuste et réutilisable, adapté aux animaux et aux humains | Plástico, para la eliminación rápida e indolora de garrapatas de diferentes tamaños (2 ganchos), de fácil manejo, robusto y reutilizable, adecuado para animales y humanos | Plastica, per la rimozione rapida e indolore di zecche di diverse dimensioni (2 ganci), facile da maneggiare, robusta e riutilizzabile, adatta ad animali ed esseri umani | Plastik, til hurtig og smertefri fjernelse af flåter i forskellige størrelser (2 kroge), nem håndtering, robust og genanvendelig, velegnet til dyr og mennesker

24er Thekendisplay | Counter display | Display de comptoir | Disposición del contador | Dispensazione del contatore | Tællerdisposition

69214

orange | orange | orange | naranja | arancione | orange

69232

himbeer | raspberry | framboise | frambuesa | lamponne | hindbær

69230

grün | green | vert | verde | verde | grøn

69215

anthrazit | anthracite | anthracite | anthracita | anthracite | antracit

69231



Praktische Haken (2er-Set) zur Entfernung von Zecken
Practical hooks (set of 2) for removing ticks



Schnell, sanft und schmerzfrei
Quickly, gently and painlessly



Minimales Risiko der Übertragung von Krankheiten oder giftigen Substanzen
Minimal risk of transmitting diseases or toxic substances



Einfache Handhabung, immer griffbereit
Easy to use, always at hand



Robust und wiederverwendbar
Robust and reusable



Ideal geeignet für Tier (Hund, Katze, Pferd, ...) und Mensch
Ideal for animals (dog, cat, horse, ...) and humans



4 x 24/Display

VIDEO

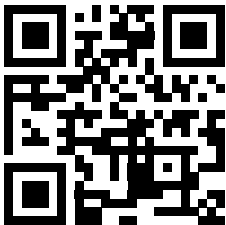

72 x 158 x 40 cm



96/Display

96er Bodendisplay Zeckenhaken AJKA

Display Tick hook | Afficher Crochet de tique | Soporte gancho para garrapatas | Espositore gancio della zecca | Display Blodmidehagen

Pappe, bestückte Lieferung, sicherer Stand, einfache Nachbestückung mit Thekendisplay (69214) | Cardboard, stocked delivery, secure stand, easy restocking with counter display (69214) | Carton, livraison équipée, stabilité assurée, réapprovisionnement facile avec présentoir de comptoir (69214) | Cartón, entrega en stock, soporte seguro, reposición fácil con expositor de mostrador (69214) | Cartone, consegna a stock, supporto sicuro, facile rifornimento con display da banco (69214) | Karton, levering på lager, sikker stand, nem genopfyldning med diskdisplay (69214)

69359 



Einfache Nachbestückung

Bei der Lieferung sind vier 24er Thekendisplays inklusive. Für die Nachbestückung werden einfach ein bis vier neue 24er Displays in die dafür vorgesehenen Fächer geschoben und schon ist die Ware aufgefüllt.

Simple restocking. Four 24 counter displays are included in the delivery. For restocking, simply slide one to four new 24-count displays into the compartments provided and the product is replenished.

Schnelles und schmerzfreies Entfernen von Zecken unterschiedlicher Größe

Quick and painless removal of ticks of different sizes

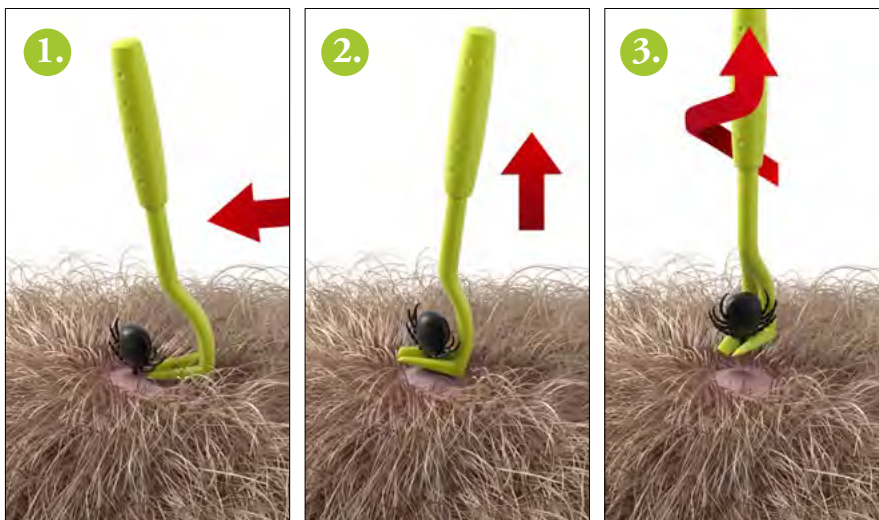

Der Zeckenhaken AJKA wird nah an der Einstichstelle 1. unter den »Eindringling« geschoben, 2. leicht angehoben und dann 3. sanft um die eigene Achse gedreht. Binnen Sekunden löst sich die Zecke vollständig aus der Haut - ganz ohne Druckausübung auf den Körper des Parasiten.

The tick hook AJKA is pushed 1. under the »intruder« close to the puncture site, 2. slightly raised and then 3. gently rotated around its own axis. Within seconds, the tick is completely detached from the skin - without exerting any pressure on the body of the parasite.





Bekleidung

— Clothing —

Hundebekleidung muss unterschiedlichsten Ansprüchen gerecht werden. An erster Stelle sollen Mäntel, Pullover und Co. den Vierbeiner vor Nässe und Kälte schützen, aber auch die optimale Passform und eine ansprechende Optik spielen eine Rolle. Beim Bekleidungsassortiment von HUNTER bleibt kein Wunsch offen – für jedes Wetter und jeden Bedarf finden Hundehalter die geeignete Kleidung.

Dog clothing must live up to highly diverse requirements. The top priority is that jackets and jumpers etc. protect our four-legged friends from moisture and cold, although a perfect fit and appealing look also play a significant role. HUNTER's clothing range has everything you could wish for – dog owners will find just the right clothing for any weather and any requirements.



Ø ↔
35 cm 10 cm

Hundeschal MALMÖ

Dog scarf | Echarpe pour chien | Bufanda para perros | Sciarpa per cani | Hundetørklede

Polyacryl, weich und elastisch, modisches Accessoire und funktionaler Kälteschutz zugleich, bei 30°C waschbar | *Polyacrylic, soft and elastic, fashionable accessory and functional protection against the cold, washable at 30°C* | Polyacrylique, doux et élastique, à la fois accessoire de mode et protection contre le froid, lavable à 30°C | *Poliacrilico, suave y elástico, complemento moderno y protección funcional contra el frío, lavable a 30°C* | *Poliacrilico, morbido ed elastico, sia un accessorio alla moda sia una funzionale protezione dal freddo, lavabile a 30°C* | *Polyakryl, blød og elastisk, moderne tilbehør og samtidig funktional beskyttelse mod kulde, vaskbar ved 30°C*

beige | tan | beige | beige | beige | beige

67320

bordeaux | bordeaux | bordeaux | burdeos | bordò | bordeaux

67321

grau | grey | gris | gris | grigio | grå

67322

anthrazit | anthracite | anthracite | anthracita | anthracite | antracit

67323

Passend für alle Hundegrößen

one size fits all





SUPER SOFT

Dreieckstuch NOLA

Triangular scarf | Foulard triangulaire | Bufanda triangular | Sciarpa triangolare | Trekantet tørklæde

Musselin (Baumwolle), angenehm weich und leicht, charakteristische Struktur, bei 30°C waschbar | *Muslin (Cotton), pleasantly soft and light, characteristic structure, washable at 30°C* | Mousseline (Coton), agréablement douce et légère, structure caractéristique, lavable à 30°C | *Muselina (Algodón), agradablemente suave y ligera, estructura característica, lavable a 30°C* | Mussola (Cotone), piacevolmente morbida e leggera, struttura caratteristica, lavabile a 30°C | *Musselin (Bomuld), behageligt blødt og let, karakteristisk struktur, vaskbar ved 30°C*

blau | blue | bleu | azul | blu | blå

S 69569  M 69570 

L 69571 

grün | green | vert | verde | verde | grøn

S 69572  M 69573 

L 69574 

grau | grey | gris | gris | grigio | grå

S 69575  M 69576 

L 69577 

Angelegt wird das Baumwolltuch ganz einfach durch Verknoten der beiden Enden.
The cotton cloth is put on simply by knotting the two ends.

↗	▣	
S	50 x 25 cm	3 Stck. pcs.
M	65 x 33 cm	3 Stck. pcs.
L	86 x 38 cm	3 Stck. pcs.

In Leinwandbindung gewebt, hat es die für Musselinstoffe so charakteristische Struktur, ist angenehm griffig, weich und leicht.

Woven in plain weave, it has the structure so characteristic of muslin fabrics, is pleasant to the touch, soft and light.



Bademantel für Hunde

Dog bathrobe



Besonders hoher Kragen
Extra high collar

Geschlossene Bauchseite
Closed belly area



Das leichte Material des Bademantels ist extrem saugstark, unterstützt so ein schnelleres Trocknen des Hundefells und schützt vor Auskühlung. Egal ob nach einem regnerischen Spaziergang, einem Ausflug an den See oder dem Bad in der heimischen Wohnung – der Hundebademantel RIGA bewahrt zusätzlich Auto, Einrichtung und Menschen vor den Wasser- und Schlammtröpfchen, die durch ausgiebiges Schütteln so schnell verteilt werden, denn sowohl Hals und Rücken als auch Brust und Bauch des Hundes sind von dem weichen Frottee-Gewebe umhüllt.

Because the light material of the bathrobe is extremely absorbent, it supports faster drying of the dog's coat and protects against chilling. Whether after a rainy walk, a trip to the lake or a bath at home - the RIGA dog bathrobe also protects the car, furnishings and people from the drops of water and mud that are so quickly spread by extensive shaking, because the dog's neck and back as well as chest and belly are wrapped in the soft terry fabric.

- ✓ **Aus besonders leichter und saugstarker Baumwolle**
Made from particularly light and absorbent cotton
- ✓ **Unterstützt schnelles Trocknen und schützt vor Auskühlen nach einem Bad**
Supports quick drying and protects against cooling down
- ✓ **Schützt nach einem Spaziergang z.B. Auto und Wohnung vor Verschmutzungen**
Protects e.g. car and home from dirt after a walk
- ✓ **Warmes und geborgenes Gefühl für den Hund**
Warm and secure feeling for the dog
- ✓ **Maschinenwaschbar bei 60 °C**
Machine washable at 60 °C





**NEW
colour**



Hunde-Bademantel RIGA

Dog bathrobe | Hunde-Peignoir de bain pour chiens | Albornoz para perro | Accappatoio per cani | Badekåbe til hunde

100% Baumwolle, besonders saugstark, trocknet und schützt vor Auskühlen, bequemer Tragekomfort, bei 60°C waschbar | 100% cotton, particularly absorbent, dries and protects against chilling, comfortable to wear, washable at 60 °C | 100% coton, particulièrement absorbant, sèche et protège du refroidissement, confortable à porter, lavable à 60°C | 100% algodón, especialmente absorbente, seca y protege contra el frío, cómodo de llevar, lavable a 60°C | 100% cotone, particolarmente assorbente, asciuga e protegge dal freddo, comodo da indossare, lavabile a 60°C | 100% bomuld, særligt absorberende, tørrer og beskytter mod nedkøling, behagelig at have på, vaskbar ved 60°C

altrosa | old pink | vieux rose | rosa viejo | rosa antico | gammel pink

30 69433 40 69434

50 69435 60 69436

70 69437

taupe

30 207847 40 207849

50 207851 60 207853

70 207855

grau | grey | gris | gris | grigio | grå

30 69428 40 69429

50 69430 60 69431

70 69432

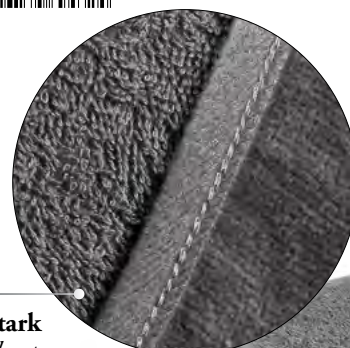

Besonders saugstark
Particularly absorbent

	Größe Size	Rückenlänge Back length	Halsumfang Neck size
	S	30 cm	40 cm
	M	40 cm	49 cm
	L	50 cm	58 cm
	XL	60 cm	68 cm
	XXL	70 cm	80 cm



Optionales Schließen durch Druckknopf unterhalb der Rute möglich
Optional fastening possible by press stud underneath the tail



Abgestimmtes Set aus Hundepullover & Mütze

Matching set of dog pullover & cap



Warmes Strickpullover- und Mützenset für kalte Tage
Warm knitted jumper and hat set for cold days



Pullover mit hohem, individuell umschlagbarem Halskragen und geschlossener Bauchseite
Jumper with high, individually foldable neck collar and closed belly side



Mütze in Einheitsgröße
One-size-fits-all hat



Hohe Elastizität für optimale Bewegungsfreiheit
High elasticity for optimum freedom of movement



Mit recyceltem Polyester
With recycled polyester





SET

SET Hundepullover & Mütze ODENSE

Dog pullover & cap | Pull-over pour chien & bonnet | Jersey para perros y gorra | Maglione per cani e berretto | Hundesweater & kasket

Polyester/Polyacryl, mit Recyclinganteil, besonders weich, langer Kragen zum individuellen Umschlagen, bei 30°C waschbar | *Polyester/polyacrylic, with recycled content, particularly soft, long collar for individual turn-up, washable at 30°C* | Polyester/polyacrylique, avec part de recyclage, particulièrement doux, long col à rabattre individuellement, lavable à 30°C | *Poliéster/poliacrílico, con contenido reciclado, especialmente suave, cuello largo con vuelta individual, lavable a 30°C* | Poliestere/poliacrilico, con contenuto riciclato, particolarmente morbido, colletto lungo da risvoltare individualmente, lavabile a 30°C | *Polyester/polyacryl, med genanvendt indhold, særligt blød, lang krave til individuel opsmøg, vaskbar ved 30°C*

beige/grün | tan/green | beige/vert | beige/verde | beige/verde | beige/grøn

25 203524  30 203525 

35 203526  40 203527 

45 203528  50 203529 

55 203530  60 203531 

creme/rosa | cream/light pink | crème/rose clair | crema/rosa pálido | crema/rosa | creme/lyserød

25 203532  30 203533 

35 203534  40 203535 

45 203536  50 203537 

55 203538  60 203539 

braun/blau | brown/blue | marron/bleu | marrón/azul | marrone/blu | brun/blå

25 203540  30 203541 

35 203542  40 203543 

45 203544  50 203545 

55 203546  60 203547 

65 203548  70 203549 

75 203550  80 203551 



↕	↔*	↔.
25	20 - 27 cm	33 - 41 cm
30	23 - 30 cm	38 - 46 cm
35	25 - 32 cm	42 - 50 cm
40	27 - 34 cm	46 - 54 cm
45	29 - 37 cm	48 - 56 cm
50	32 - 40 cm	52 - 60 cm
55	35 - 43 cm	56 - 64 cm
60	37 - 45 cm	59 - 67 cm
65	40 - 48 cm	63 - 71 cm
70	43 - 51 cm	67 - 75 cm
75	46 - 54 cm	70 - 78 cm
80	49 - 57 cm	74 - 82 cm



**MIT
RECYCLING
ANTEIL**

With recycled content



⇒	↔*	↔.
25	24 – 30 cm	33 – 41 cm
30	26 – 32 cm	38 – 46 cm
35	30 – 37 cm	42 – 50 cm
40	28 – 35 cm	46 – 54 cm
45	29 – 36 cm	48 – 56 cm
50	33 – 40 cm	52 – 60 cm
55	35 – 42 cm	56 – 64 cm
60	39 – 46 cm	59 – 67 cm



Hundepullover BIRKA

Dog pullover | Pull-over pour chiens | Jersey para perros | Maglioncino per cani | Hundesweater

Polyester, besonders weich, langer Kragen zum individuellen Umschlagen, bei 30°C waschbar | *Polyester, particularly soft, individually adjustable collar length, washable at 30°C* | Polyester, particulièrement doux, long col à rabattre individuellement, lavable à 30°C | *Poliéster, especialmente suave, cuello largo con vuelta individual, lavable a 30°C* | Poliestere, particolarmente morbido, collo lungo da risvoltare individualmente, lavabile a 30°C | *Polyester, særligt blødt, lang krave til individuel opsmøg, vaskbar ved 30°C*

rot | red | rouge | rojo | rosso | rød

25	203468	30	203469
35	203470	40	203471
45	203472	50	203473
55	203474	60	203475

graublau | grey blue | gris-bleu | gris azul | grigio blu | gråblå

25	203476	30	203477
35	203478	40	203479
45	203480	50	203481
55	203482	60	203483





Hundepullover MALMÖ

Dog pullover | Pull-over pour chiens | Jersey para perros | Maglioncino per cani | Hundesweater

Polyacryl, Öffnung zum Befestigen einer Leine am Halsband, bei 30°C waschbar | *Polyacrylic, hole for securing a leash to the collar, washable at 30°C* | Polyacrylique, ouverture pour attacher une laisse au collier, lavable à 30°C | *Poliacrilico, orificio para fijar la correa en el collar, lavable a 30°C* | *Poliacrilico, apertura per fissare il guinzaglio al collare, lavabile a 30°C* | *Polyakryl, åbning til fastgørelse af line på halsbåndet, vaskbar ved 30°C*

beige | tan | beige | beige | beige | beige

25 62876 30 62877

35 62878 40 62879

45 62880 50 62881

bordeaux | bordeaux | bordeaux | burdeos | bordò | bordeaux

25 62882 30 62883

35 62884 40 62885

45 62886 50 62887

khaki | kaki | kaki | caqui | cachi | kaki

25 69499 30 69500

35 69501 40 69502

45 69503 50 69504

grau | grey | gris | gris | grigio | grå

25 66346 30 66347

35 66348 40 66349

45 66350 50 66351

anthrazit | anthracite | anthracite | anthracita | anthracite | antracit

25 66352 30 66353

35 66354 40 66355

45 66356 50 66357



⇒	↔	↔
25	18 – 30 cm	34 – 44 cm
30	26 – 34 cm	40 – 46 cm
35	28 – 38 cm	44 – 50 cm
40	32 – 42 cm	50 – 60 cm
45	34 – 46 cm	54 – 64 cm
50	36 – 50 cm	58 – 68 cm

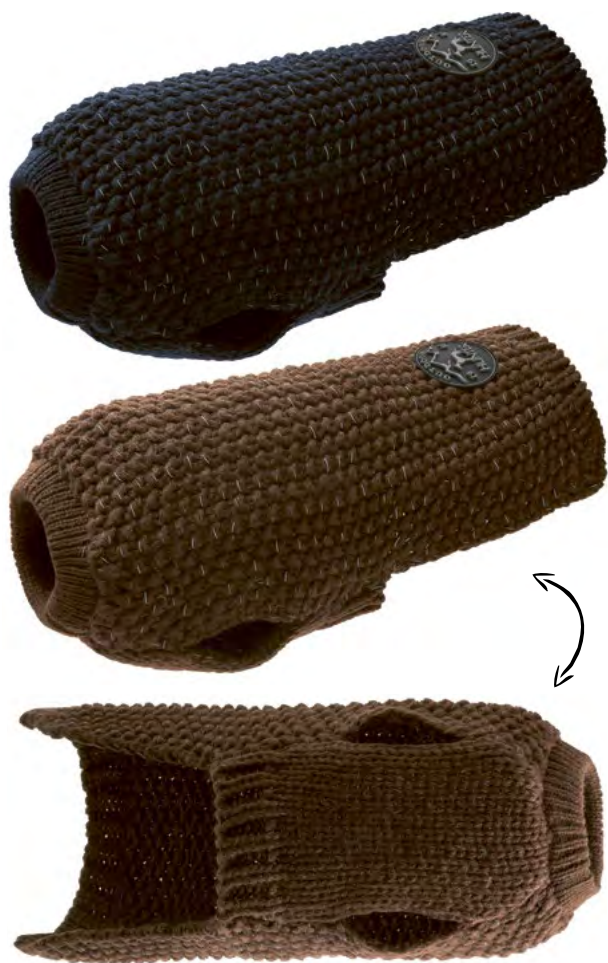

Hundepullover FINJA

Dog p ani | Hundesweater

Polyacryl, mit reflektierendem Garn, Öffnung zum Befestigen einer Leine am Halsband, bei 30°C waschbar | Polyacrylic, with reflecting thread, hole for securing a leash to the collar, washable at 30°C |

Polyacrylique, avec fil réfléchissant, ouverture pour attacher une laisse au collier, lavable à 30°C | Poliacrílico, con hilo reflectante, orificio para fijar la correa en el collar, lavable a 30°C | Poliacrilico, con filato riflettente, apertura per fissare il guinzaglio al collare, lavabile a 30°C | Polyakryl, med reflekterende garn, åbning til fastgørelse af line på halsbåndet, vaskbar ved 30°C

d-blau | dark blue | bleu foncé | azul oscuro | blu scuro | mørkeblå

35	67867		40	67868	
45	67869		50	67870	
55	67871		60	67872	
65	67873				

braun | brown | marron | marrón | marrone | brun

35	67874		40	67875	
45	67876		50	67877	
55	67878		60	67879	
65	67880				



Auch für große Hunde – bis 65 cm Rückenlänge!

Also for large dogs - up to 65 cm back

↕	↔*	↔.
35	28 - 38 cm	44 - 50 cm
40	32 - 42 cm	50 - 60 cm
45	34 - 46 cm	54 - 64 cm
50	36 - 50 cm	58 - 68 cm
55	50 - 62 cm	60 - 80 cm
60	55 - 70 cm	64 - 90 cm
65	60 - 80 cm	66 - 100 cm





Reflektierendes Garn
reflective yarn



Regenmantel to go für Hunde

Rain coat for dogs

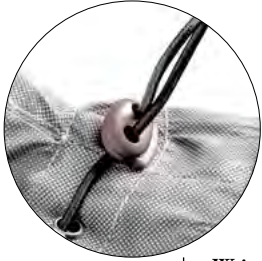

Weitenregulierbarer Kragen durch Gummizug
Width-adjustable collar with elastic band



Leichter, wasserabweisender Regenmantel für Hunde
Lightweight, water-repellent rain coat for dogs

Ansprechendes, Camouflage-Design in dezentem Silber
Attractive, camouflage design in subtle silver



Befestigung der Leine an Geschirr und Halsband möglich
Leash can be attached to harness and collar



Mit integrierter Aufbewahrungstasche platzsparend verstaubar
With integrated space-saving storage bag



Sichtbarkeit bei schwierigen Verhältnissen durch komplett reflektierendes Material
Visibility in difficult conditions due to fully reflective material





Hunde-Regenmantel to go HUKA

Rain coat for dogs to go | Imperméable pour chiens to go | Impermeable para perros to go | Impermeabile per cani to go | Regnfrakke til hunde to go

Polyester, wasserabweisend, komplett reflektierend, weitenregulierbarer Bauchgurt mit Klettverschluss, weitenregulierbarer Kragen, elastische Fixiergummis an den Hinterläufen, mit Öffnungen zum Befestigen einer Leine am Halsband oder Geschirr, mit integriertem Transportbeutel inklusive Karabiner, bei 30°C waschbar | Polyester, water-repellent, completely reflective, adjustable belly strap with Velcro fastener, adjustable collar, elastic fixation elastics on the hind legs, with openings for attaching a leash to the collar or harness, with integrated transport bag including carabiner, washable at 30°C | Polyester, hydrofuge, entièrement réfléchissant, ceinture ventrale réglable en largeur avec velcro, col réglable en largeur, élastiques de fixation aux pattes arrière, avec ouvertures pour attacher une laisse au collier ou au harnais, avec sac de transport intégré, mousqueton inclus, lavable à 30°C | Poliéster, hidrófugo, totalmente reflectante, correa ventral ajustable con cierre de velcro, collar ajustable, elásticos de fijación en las patas traseras, con aberturas para fijar una correa al collar o al arnés, con bolsa de transporte integrada que incluye mosquetón, lavable a 30°C | Poliestere, idrorepellente, completamente riflettente, fascia addominale regolabile con chiusura in velcro, collare regolabile, elastici di fissaggio sulle zampe posteriori, con aperture per il fissaggio di un guinzaglio al collare o alla pettorina, con borsa di trasporto integrata con moschettone, lavabile a 30°C | Polyester, vandafvisende, fuld refleks, justerbar mavebelte med velcrolukning, justerbar krave, elastiske fastgørelsesbånd på bagbenene, med åbninger til at fastgøre en snor til halsbåndet eller selen, med integreret transporttaske inklusive karabinhage, vaskbar ved 30°C

silber | silver | argent | argenteo | argento | sølv

25	69438		30	69439	
35	69440		40	69441	
45	69442		50	69443	
55	69444		60	69445	
65	69446				

↕	↔*	↔.
25	20 – 38 cm	19 – 40 cm
30	30 – 40 cm	29 – 49 cm
35	26 – 42 cm	35 – 55 cm
40	30 – 56 cm	40 – 63 cm
45	32 – 58 cm	43 – 66 cm
50	34 – 60 cm	44 – 68 cm
55	36 – 72 cm	45 – 73 cm
60	38 – 74 cm	50 – 78 cm
65	40 – 76 cm	53 – 80 cm

Geschlossene Bauchseite
Closed belly side





Hunde-Regenmantel UPPSALA RAIN

Rain coat for dogs | Imperméable pour chiens | Impermeable para perros | Impermeabile per cani | Regnfrakke til hund

Polyester, wasserabweisend, reflektierend, weitenregulierbarer Bauchgurt mit Klettverschluss, weitenregulierbarer Kragen, Öffnung zum Befestigen einer Leine am Halsband, mit Transportbeutel, bei 30°C waschbar | Polyester, water-repellent, reflective, adjustable waist strap with velcro fastening, adjustable collar, hole for securing a leash to the collar, comes with transport bag, washable at 30°C | Polyester, hydrofuge, réfléchissant, sangle abdominale réglable en largeur avec fermeture velcro, col réglable en largeur, ouverture pour attacher une laisse au collier, avec sac de transport, lavable à 30°C | Poliéster, repelente al agua, reflectante, ancho de cinturón regulable con cierre de velcro, ancho de cuello regulable, orificio para fijar la correa en el collar, con bolsa de transporte, lavable a 30°C | Poliestere, etancheidrepellente, riflettente, cinturino regolabile in vita con chiusura a velcro, colletto regolabile, apertura per fissare il guinzaglio al collare, con sacca per il trasporto, lavabile a 30°C | Polyester, vandafvisende, reflekterende, vidderegulerbar maverem med borrelås, vidderegulerbar krave, åbning til fastgørelse af line på halsbåndet, med transportpose, vaskbar ved 30°C

rot | red | rouge | rojo | rosso | rød

30 66247 35 66248

40 66249 45 66250

50 66251 55 66252

60 66253 65 66254

schwarz | black | noir | negro | nero | sort

25 66258 30 66259

35 66260 40 66261

45 66262 50 66263

55 66264 60 66265

65 66266 70 66267

75 66268

XXL

⇒	↔*	↔.
25	18 – 38 cm	26 – 36 cm
30	20 – 44 cm	38 – 46 cm
35	26 – 54 cm	40 – 52 cm
40	28 – 58 cm	46 – 60 cm
45	30 – 58 cm	50 – 62 cm
50	32 – 60 cm	52 – 64 cm
55	34 – 70 cm	56 – 70 cm
60	34 – 72 cm	58 – 74 cm
65	34 – 74 cm	60 – 76 cm
70	36 – 78 cm	62 – 80 cm
75	38 – 83 cm	64 – 84 cm



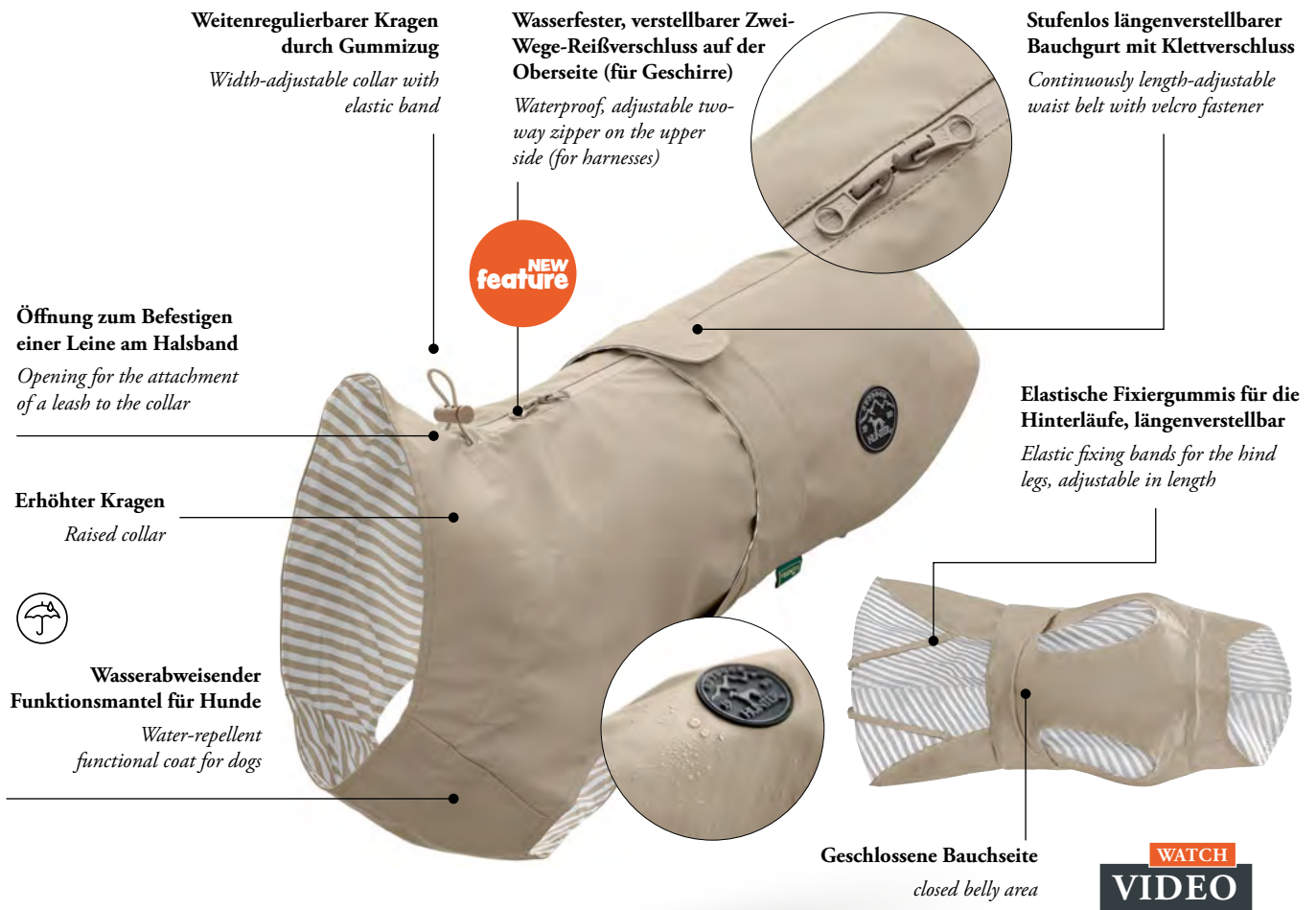

MILFORD

Gestatten, MILFORD! Er ähnelt dem klassischen Friesennerz und ist ebenso praktisch und funktional wie die »Menschen-Variante« des verlässlichen Must-Haves. Die besonderen Bedürfnisse von Vierbeinern wurden beim Design von MILFORD selbstverständlich berücksichtigt. So sorgen elastische Bänder an den Hinterläufen für einen perfekten Sitz des leichten Mantels, auch bei starken Windböen. Der empfindliche Hals sowie Rücken und Bauch des Hundes werden dank der ergonomischen Passform perfekt geschützt ohne die Bewegungsfreiheit einzuschränken. Geschlossen wird der Hunderegenmantel MILFORD im Handumdrehen und ganz individuell mittels breitem Klettband. Dieses wird auf dem Rücken verschlossen und kann ruckzuck angepasst werden wenn sich im Laufe des feuchtfröhlichen Spaziergangs herausstellt, dass MILFORD doch etwas zu weit oder zu eng sitzt. Das ansprechende, gestreifte Innenfutter aus glattem Polyesterstoff macht das Tragen des Mantels besonders angenehm - völlig gleich ob krauses oder glattes, kurzes oder langes Fell. Die Pflege des MILFORD-Mantels gestaltet sich denkbar einfach: Mit einem weichen, feuchten Tuch kann jeglicher Schmutz einfach abgewischt werden, sofern das nicht bereits der Regen auf ganz natürliche Art und Weise übernommen hat. Alternativ leistet die Waschmaschine bei 30 °C wertvolle Dienste, um die Farben wieder satt strahlen zu lassen. Ideal für Zwei- und Vierbeiner, die dem »Schmuddelwetter« die kalte Schnauze zeigen wollen!

Allow me, MILFORD! It resembles the classic oilskin jacket and is just as practical and functional as the »human version« of the reliable must-have. Of course, the special needs of four-legged friends were taken into account in the design of MILFORD. Elastic straps on the hind legs ensure that the lightweight coat fits perfectly, even in strong gusts of wind. Thanks to the ergonomic fit, the dog's sensitive neck, back and belly are perfectly protected without restricting freedom of movement. The dog rain coat MILFORD is closed in an instant and individually by means of a wide velcro strap. This is fastened on the back and can be adjusted in no time if it turns out during the course of a damp walk that MILFORD is a little too wide or too tight. The attractive striped lining made of smooth polyester fabric makes the coat particularly comfortable to wear - regardless of whether the dog's coat is curly or smooth, short or long. The MILFORD coat is very easy to care for: any dirt can simply be wiped off with a soft, damp cloth, provided the rain hasn't already done this naturally. Alternatively, the washing machine can be used at 30 °C to restore the colours to their full brilliance. Ideal for two-legged and four-legged friends who want to show the »muddy weather« the cold snout!



Hunde-Regenmantel MILFORD

Rain coat for dogs | Imperméable pour chiens | Impermeable para perros | Impermeabile per cani | Regnfrakke til hunde

Polyester, wasserfest, wasserfester und verstellbarer Zwei-Wege-Reißverschluss auf der Oberseite für Geschirre, weitenregulierbarer Bauchgurt mit Klettverschluss, weitenregulierbarer Kragen, Öffnung zum Befestigen einer Leine am Halsband, elastische Fixiergummis für die Hinterläufe, bei 30 °C waschbar | Polyester, water-proof, water-repellent and adjustable two-way zipper on the top side for harnesses, width-adjustable belly strap with velcro fastener, width-adjustable collar, opening for attaching a leash to the collar, elastic fixation rubbers for the hind legs, washable at 30 °C | Polyester, étanche, double fermeture zippée hydrofuge et ajustable sur la partie supérieure pour les harnais, sangle ventrale réglable avec fermeture velcro, collier réglable, ouverture pour attacher une laisse au collier, sangles de fixation élastiques pour les pattes arrière, lavable à 30 °C | Poliéster, impermeable, cremallera doble repelente al agua y ajustable en la parte superior para arneses, correa para el vientre ajustable con cierre de velcro, cuello ajustable, abertura para fijar una correa al cuello, correas de fijación elásticas para las patas traseras, lavable a 30 °C | Poliestere, impermeabile, cerniera bidirezionale idrorepellente e regolabile sulla parte superiore per pettorine, cinghia a pancia regolabile con chiusura in velcro, collare regolabile, apertura per il fissaggio di un guinzaglio al collare, cinghie elastiche di fissaggio per le zampe posteriori, lavabile a 30 °C | Polyester, vandtet, vandfast og indstillelig to-vejs lynlås på seletøjets overside, breddejusterbar linning med velcrolukning, breddejusterbar krave, åbning til fastgørelse af snor i kraven, elastiske elastikker til bagbenene, vaskbar ved 30 °C

XXL

gelb | yellow | jaune | amarillo | giallo | gul

25	69734		30	69735	
35	69736		40	69737	
45	69738		50	69739	
55	69740		60	69741	
65	69742		70	69743	
75	69744		80	69745	

orange | orange | orange | naranja | arancione | orange

25	204068		30	204070	
35	204072		40	204074	
45	204076		50	204078	
55	204080		60	204082	
65	204084		70	204086	
75	204088		80	204090	

⇒	↔*	↔.
25	20 – 38 cm	26 – 40 cm
30	22 – 40 cm	35 – 49 cm
35	26 – 42 cm	40 – 55 cm
40	30 – 56 cm	46 – 63 cm
45	32 – 58 cm	50 – 66 cm
50	34 – 60 cm	51 – 68 cm
55	36 – 72 cm	57 – 73 cm
60	38 – 74 cm	60 – 78 cm
65	40 – 76 cm	63 – 80 cm
70	42 – 78 cm	60 – 82 cm
75	44 – 84 cm	65 – 87 cm
80	46 – 86 cm	67 – 89 cm





water-repellent and adjustable
 • wasserfester und verstellbarer
 Zwei-Wege-Reißverschluss
 für Geschirre
 • two-way-zipper for harnesses

blau | blue | bleu | azul | blu | blå

25	69746		30	69747	
35	69748		40	69749	
45	69750		50	69751	
55	69752		60	69753	
65	69754		70	69755	
75	69756		80	69757	

grün | green | vert | verde | verde | grøn

25	69661		30	69662	
35	69663		40	69664	
45	69665		50	69666	
55	69667		60	69668	
65	69669		70	69670	
75	69671		80	69672	

taupe

25	69673		30	69674	
35	69675		40	69676	
45	69677		50	69678	
55	69679		60	69680	
65	69681		70	69682	
75	69683		80	69684	

schwarz | black | noir | negro | nero | sort

25	207823		30	207825	
35	207827		40	207829	
45	207831		50	207833	
55	207835		60	207837	
65	207839		70	207841	
75	207843		80	207845	





Hundemantel NORDBY

*Dog coat | Manteau pour chiens | Abrigo para perros
| Cappottino per cani | Hundefrakke*

Polyester, wasserabweisend, wärmendes Fleece-Innenfutter, reflektierend, wasserfester und verstellbarer Zwei-Wege-Reißverschluss auf der Oberseite für Geschirre, weitenregulierbarer, elastischer Bauchgurt mit Klickverschluss, weitenregulierbarer Hals- und Rutenbereich, verlängertes Kragen, Öffnung zum Befestigen einer Leine am Halsband, elastische Fixiergummis für die Hinterläufe, bei 30°C waschbar |

Polyester, water-repellent, warming fleece lining, reflective, waterproof and adjustable two-way zip on the top for harnesses, adjustable, elasticated waist belt with click fastener, adjustable neck and tail area, extended collar, opening for attaching a lead to the collar, elasticated fixation straps for the hind legs, washable at 30°C | Polyester, hydrofuge, doublure chaude en polaire, réfléchissant, fermeture éclair à double sens imperméable et réglable sur le dessus pour harnais, ceinture ventrale élastique réglable en largeur avec fermeture à clic, cou et queue réglables en largeur, col rallongé, ouverture pour fixer une laisse au collier, élastiques de fixation pour les pattes arrière, lavable à 30°C | Poliéster, repelente al agua, forro polar cálido, reflectante, cremallera bidireccional impermeable y ajustable en la parte superior para los arneses, cinturón ajustable y elástico con cierre de clic, zona del cuello y de la cola ajustables, cuello alargado, abertura para fijar una correa al cuello, correas de fijación elásticas para las patas traseras, lavable a 30°C | Poliester, idrorepellente, fodera in pile riscaldante, riflettente, impermeabile e regolabile, cerniera a due vie sulla parte superiore per le imbracature, cintura in vita regolabile ed elastica con chiusura a scatto, collo e coda regolabili, colletto allungato, apertura per il fissaggio di un guinzaglio al colletto, cinghie di fissaggio elastiche per le zampe posteriori, lavabile a 30°C | Polyester, vandafvisende, varmende fleecefor, reflekser, vandtæt og justerbar tovejs-lynlås foroven til seler, justerbar, elastisk taljebælte med klikspænde, justerbar hals- og haleparti, forlænget krave, åbning til fastgørelse af en snor i kraven, elastiske fastgørelsesremme til bagbenene, vaskbar ved 30°C

SPECIAL FIT

↕	↔*	↔.
25	26 – 36 cm	30 – 50 cm
27,5	27 – 37 cm	31 – 51 cm
30	28 – 38 cm	33 – 53 cm
32,5	29 – 39 cm	35 – 56 cm
35	30 – 40 cm	37 – 58 cm
37	33 – 43 cm	39 – 60 cm
40	35 – 45 cm	41 – 62 cm
42,5	38 – 48 cm	44 – 66 cm
45	39 – 50 cm	47 – 68 cm
47,5	42 – 53 cm	50 – 72 cm
50	43 – 55 cm	53 – 76 cm
55	45 – 58 cm	56 – 79 cm
60	47 – 60 cm	60 – 83 cm
65	50 – 63 cm	64 – 88 cm
70	52 – 65 cm	69 – 92 cm
75	55 – 68 cm	72 – 97 cm
80	57 – 70 cm	77 – 101 cm

Dachshund

↕	↔*	↔.
33	26 – 36 cm	31 – 51 cm
36	29 – 39 cm	35 – 56 cm
40	32 – 42 cm	39 – 60 cm
45	34 – 45 cm	43 – 65 cm

Pug & Bulldog

↕	↔*	↔.
32	36 – 46 cm	39 – 59 cm
36	40 – 50 cm	43 – 65 cm
40	44 – 54 cm	47 – 68 cm
44	48 – 58 cm	51 – 71 cm

XXL



**MIT SPEZIAL-PASSFORM
für Dackel, Mops & Bulldogge**

With special fit for dachshund, pug and bulldog





Dachshund

creme | cream | crème | crema | crema | creme

30	203407	32,5	203408
35	203409	37,5	203410
40	203411	42,5	203412
45	203413	47,5	203414
50	203415	55	203416
60	203417	65	203418

orange | orange | orange | naranja | arancione | orange

30	203419	32,5	203420
35	203421	37,5	203422
40	203423	42,5	203424
45	203425	47,5	203426
50	203427	55	203428
60	203429	65	203430

oliv | olive | olive | oliva | oliva | olivenfarvet

25	203431	27,5	203432
30	203433	32,5	203434
35	203435	37,5	203436
40	203437	42,5	203438
45	203439	47,5	203440
50	203441	55	203442
60	203443	65	203444
70	203445	75	203446
80	203447		

schwarz | black | noir | negro | nero | sort

25	207701	27,5	207703
30	207705	32,5	207707
35	207709	37,5	207711
40	207713	42,5	207715
45	207717	47,5	207719
50	207721	55	207723
60	207725	65	207727
70	207729	75	207731
80	207733		

creme | cream | crème | crema | crema | creme

33	203484	36	203485
40	203486	45	203487

orange | orange | orange | naranja | arancione | orange

33	203488	36	203489
40	203490	45	203491

oliv | olive | olive | oliva | oliva | olivenfarvet

33	203492	36	203493
40	203494	45	203495

schwarz | black | noir | negro | nero | sort

33	207735	36	207737
40	207739	45	207741



Pug & Bulldog

creme | cream | crème | crema | crema | creme

32	203496	36	203497
40	203498	44	203499

orange | orange | orange | naranja | arancione | orange

32	203500	36	203501
40	203502	44	203503

oliv | olive | olive | oliva | oliva | olivenfarvet

32	203504	36	203505
40	203506	44	203507

schwarz | black | noir | negro | nero | sort

32	207743	36	207745
40	207747	44	207749

Der leichte, wasserabweisende Funktionsmantel

The lightweight, water-repellent functional coat

NORDBY



Leichter, wasserabweisender Funktionsmantel für Hunde

Lightweight, water-repellent functional coat for dogs

Befestigung der Leine an Geschirr und Halsband möglich
Leash can be attached to harness and collar



Wasserfester und verstellbarer Zwei-Wege-Reißverschluss für Geschirre

Water-repellent and adjustable two-way-zipper for harnesses

Mit wärmendem Fleece-Innenfutter

With warming fleece lining



Mit hohem Halskragen und geschlossener Bauchseite

With high neck collar and closed belly side

Individuell einstellbarer, elastischer Bauchgurt

Individually adjustable, elasticated belly strap



Elastische Schlaufen für die Hinterläufe

Elasticated loops for the hind legs



Wasserabweisender Puffermantel

Water-repellent buffer jacket

PAXSON



Wasserabweisender Puffermantel für Hunde
Water-repellent puffer coat for dogs



Sichtbarkeit bei schwierigen Verhältnissen durch reflektierende Paspeln

Visibility in difficult conditions thanks to reflective piping

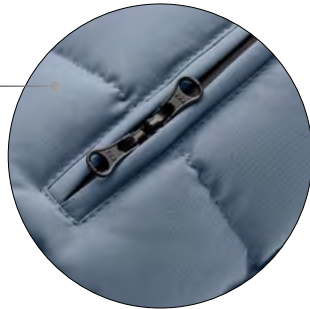

Wasserfester und verstellbarer Zwei-Wege-Reißverschluss für Geschirre

Water-repellent and adjustable two-way-zipper for harnesses

Mit wärmerer, großzügiger Wattierung

With warming, generous padding

Befestigung der Leine an Geschirr und Halsband möglich

Leash can be attached to harness and collar



Individuell einstellbarer, elastischer Bauchgurt

Individually adjustable, elasticated belly strap



Elastische Schlaufen für die Hinterläufe

Elasticated loops for the hind legs



Mit hohem Halskragen und geschlossener Bauchseite

With high neck collar and closed belly side



XXL



**NEW
colour**

Hundemantel PAXSON

*Dog coat | Manteau pour chiens | Abrigo para perros
| Cappottino per cani | Hundefrakke*

Polyester, wasserabweisend, großzügige, wärmende Wattierung, reflektierend, wasserfester und verstellbarer Zwei-Wege-Reißverschluss auf der Oberseite für Geschirre, weitenregulierbarer, elastischer Bauchgurt mit Klickverschluss, weitenregulierbarer Hals- und Rutenbereich, verlängerter Kragen, Öffnung zum Befestigen einer Leine am Halsband, elastische Fixiergummis für die Hinterläufe, bei 30°C waschbar | *Polyester, water-repellent, generous, warming padding, reflective, waterproof and adjustable two-way zip on the top for harnesses, adjustable, elasticated waist belt with click fastener, adjustable neck and tail area, extended collar, opening for attaching a lead to the collar, elasticated fixation straps for the hind legs, washable at 30°C* | Polyester, hydrofuge, rembourrage généreux et chaud, réfléchissant, fermeture éclair à double sens imperméable et réglable sur le dessus pour harnais, ceinture ventrale élastique réglable en largeur avec fermeture à clic, cou et queue réglables en largeur, col rallongé, ouverture pour attacher une laisse au collier, élastiques de fixation pour les pattes arrière, lavable à 30°C | *Poliéster, repelente al agua, acolchado generoso y cálido, reflectante, cremallera bidireccional impermeable y ajustable en la parte superior para los arneses, cinturón elástico ajustable con cierre de clic, zona del cuello y de la cola ajustables, cuello alargado, abertura para fijar una correa al cuello, correas de fijación elásticas para las patas traseras, lavable a 30 °C* | Poliestere, idrorepellente, imbottitura generosa e riscaldante, riflettente, impermeabile e regolabile, cerniera a due vie sulla parte superiore per le imbracature, cintura in vita regolabile ed elastica con chiusura a scatto, collo e coda regolabili, colletto allungato, apertura per il fissaggio di un guinzaglio al colletto, cinghie di fissaggio elastiche per le zampe posteriori, lavabile a 30°C | *Polyester, vandafuisende, generos, varmende polstring, reflekterende, vandtæt og justerbar tovejs-lynlås foroven til seler, justerbar, elastisk taljebælte med klikspænde, justerbar hals- og haleområde, forlænget krave, åbning til fastgørelse af en snor til kraven, elastiske fastgørelsesremme til bagbenene, vaskbar ved 30°C*

SPECIAL FIT

⇒	↔*	↔.
25	26 – 34 cm	30 – 50 cm
30	30 – 38 cm	34 – 54 cm
35	34 – 42 cm	38 – 59 cm
40	36 – 46 cm	41 – 62 cm
45	40 – 50 cm	46 – 68 cm
50	44 – 54 cm	51 – 74 cm
55	48 – 58 cm	56 – 79 cm
60	52 – 62 cm	61 – 84 cm
65	55 – 65 cm	65 – 89 cm
70	58 – 68 cm	69 – 93 cm
75	61 – 71 cm	73 – 97 cm
80	64 – 74 cm	77 – 101 cm

Dachshund

⇒	↔*	↔.
33	25 – 35 cm	34 – 54 cm
36	28 – 38 cm	36 – 57 cm
40	31 – 41 cm	39 – 60 cm
45	34 – 44 cm	42 – 63 cm

Pug & Bulldog

⇒	↔*	↔.
32	38 – 50 cm	41 – 62 cm
36	40 – 52 cm	45 – 67 cm
40	43 – 54 cm	49 – 70 cm
44	44 – 56 cm	53 – 76 cm



**MIT SPEZIAL-PASSFORM
für Dackel, Mops & Bulldogge**

With special fit for dachshund, pug and bulldog





Dachshund

taubenblau | dove blue | bleu pigeon | azul paloma | blu colomba | dueblå

30	203460	35	203461
40	203462	45	203463
50	203464	55	203465
60	203466	65	203467

oliv | olive | olive | oliva | oliva | olivenfarvet

30	207751	35	207753
40	207755	45	207757
50	207759	55	207761
60	207763	65	207765

karamell | caramel | caramel | caramelo | caramello | karamell

25	203448	30	203449
35	203450	40	203451
45	203452	50	203453
55	203454	60	203455
65	203456	70	203457
75	203458	80	203459

schwarz | black | noir | negro | nero | sort

25	207783	30	207785
35	207787	40	207789
45	207791	50	207793
55	207795	60	207797
65	207799	70	207801
75	207803	80	207805

taubenblau | dove blue | bleu pigeon | azul paloma | blu colomba | dueblå

33	203512	36	203513
40	203514	45	203515

oliv | olive | olive | oliva | oliva | olivenfarvet

33	207767	36	207769
40	207771	45	207773

karamell | caramel | caramel | caramelo | caramello | karamell

33	203508	36	203509
40	203510	45	203511

schwarz | black | noir | negro | nero | sort

33	207807	36	207809
40	207811	45	207813



Pug & Bulldog

taubenblau | dove blue | bleu pigeon | azul paloma | blu colomba | dueblå

32	203520	36	203521
40	203522	44	203523

oliv | olive | olive | oliva | oliva | olivenfarvet

32	207775	36	207777
40	207779	44	207781

karamell | caramel | caramel | caramelo | caramello | karamell

32	203516	36	203517
40	203518	44	203519

schwarz | black | noir | negro | nero | sort

32	207815	36	207817
40	207819	44	207821

SOFTSHELL



XXL



⇒	↔*	↔.
30	22 – 40 cm	36 – 60 cm
35	26 – 42 cm	48 – 66 cm
40	30 – 56 cm	56 – 80 cm
45	32 – 58 cm	58 – 84 cm
50	34 – 60 cm	60 – 92 cm
55	36 – 72 cm	66 – 102 cm
60	38 – 74 cm	70 – 104 cm

Hundemantel UPPSALA SOFTSHELL

Dog coat | Manteau pour chiens | Abrigo para perros | Cappottino per cani | Hundefrakke

Polyester, wasserabweisend, winddicht, wärmendes Fleece-Innenfutter, reflektierend, weitenregulierbarer Bauchgurt mit Klickverschluss, weitenregulierbarer Kragen, Öffnung zum Befestigen einer Leine am Halsband, elastische Fixiergummis für die Hinterläufe, bei 30°C waschbar | *Polyester, water-repellent, windproof, warming fleece inner lining, reflective, adjustable waist strap with click closing, adjustable collar, hole for securing a leash to the collar, elasticated rubber loops for the hind legs, washable at 30°C* | Polyester, hydrofuge, coupe-vent, doublure intérieure en polaire, réfléchissant, sangle abdominale réglable en largeur avec fermeture à clic, col réglable en largeur, ouverture pour attacher une laisse au collier, élastiques de fixation aux pattes arrière, lavable à 30°C | *Poliéster, repelente al agua, resistente al viento, forro polar interior, reflectante, ancho de cinturón regulable on cierre de clic, ancho de cuello regulable, orificio para fijar la correa en el collar, goma de fijación elástica para patas traseras, lavable a 30°C* | Poliestere, idrorepellente, antivento, imbottitura interna in pile, riflettente, cinturino regolabile in vita con chiusura a scatto, colletto regolabile, apertura per fissare il guinzaglio al collare, nastri elastici di fissaggio per le zampe posteriori, lavabile a 30°C | *Polyester, vandafvisende, vindtæt, varmt fleecefor, reflekterende, vidderegulerbar maverem med kliklukning, vidderegulerbar krave, åbning til fastgørelse af line på Halsbåndet, elastisk fikseringsgummi til bagbenene, vaskbar ved 30°C*

schwarz | black | noir | negro | nero | sort

30	62944		35	62945	
40	62946		45	62947	
50	62948		55	62949	
60	62950				







XXL

Hundemantel UPPSALA

Dog coat | Manteau pour chiens | Abrigo para perros | Cappottino per cani | Hundefrakke

Polyester, wasserabweisend, herausknöpfbares, wärmendes Fleece-Innenfutter, reflektierend, weitenregulierbarer Bauchgurt mit Klickverschluss, weitenregulierbarer Kragen, Öffnung zum Befestigen einer Leine am Halsband, elastische Fixiergummis für die Hinterläufe, bei 30°C waschbar | *Polyester, water-repellent, removable, warming fleece inner lining, reflective, adjustable waist strap with click closing, adjustable collar, hole for securing a leash to the collar, elasticated rubber loops for the hind legs, washable at 30°C* | Polyester, hydrofuge, doublure intérieure en polaire détachable et chauffante, réfléchissant, sangle abdominale réglable en largeur avec fermeture à clic, col réglable en largeur, ouverture pour attacher une laisse au collier, élastiques de fixation aux pattes arrière, lavable à 30°C | *Poliéster, repelente al agua, forro polar interior abrigado extraíble con botón, reflectante, ancho de cinturón regulable on cierre de clic, ancho de cuello regulable, orificio para fijar la correa en el collar, goma de fijación elástica para patas traseras, lavable a 30°C* | Poliester, idrorepellente, imbottitura interna in pile sfoderabile, riflettente, cinturino regolabile in vita con chiusura a scatto, colletto regolabile, apertura per fissare il guinzaglio al collare, nastri elastici di fissaggio per le zampe posteriori, lavabile a 30°C | *Polyester, vandafvisende, varmt fleecefor, der kan knappes af, reflekterende, viddereregulerbar maverem med kliklukning, viddereregulerbar krave, åbning til fastgørelse af line på halsbåndet, elastisk fikseringsgummi til bagbenene, vaskbar ved 30°C*

2-IN-1

altrosa | old pink | vieux rose | rosa viejo | rosa antico | gammel pink

25	69949		27,5	69950	
30	69951		32,5	69952	
35	69953		37,5	69954	
40	69955		42,5	69956	
45	69957		47,5	69958	
50	69959		55	69960	
60	69961		65	69962	
70	69963		75	69964	
80	69965				



⇒	↔*	↔.
25	20 – 38 cm	30 – 40 cm
27,5	21 – 39 cm	33 – 50 cm
30	22 – 40 cm	36 – 60 cm
32,5	24 – 40 cm	42 – 63 cm
35	26 – 42 cm	48 – 66 cm
37,5	28 – 49 cm	52 – 73 cm
40	30 – 56 cm	56 – 80 cm
42,5	31 – 57 cm	57 – 82 cm
45	32 – 58 cm	58 – 84 cm
47,5	33 – 59 cm	59 – 88 cm
50	34 – 60 cm	60 – 92 cm
55	36 – 72 cm	66 – 102 cm
60	38 – 74 cm	70 – 104 cm
65	40 – 76 cm	72 – 112 cm
70	42 – 78 cm	74 – 118 cm
75	44 – 84 cm	76 – 124 cm
80	46 – 86 cm	78 – 128 cm

ZWISCHENGRÖSSEN

- mehr Auswahl für noch mehr Passgenauigkeit
Intermediate sizes - more choice for an even better fit



water-repellent and adjustable
 wasserfester und verstellbarer
 Zwei-Wege-Reißverschluss
 für Geschirre*
 two-way-zipper for harnesses*



2-in-1

herausknöpfbares,
 wärmendes Fleece-Innenfutter
 detachable, warm fleece inner lining

khaki | kaki | kaki | caqui | cachi | kaki

25	69966		27,5	69967	
30	69968		32,5	69969	
35	69970		37,5	69971	
40	69972		42,5	69973	
45	69974		47,5	69975	
50	69976		55	69977	
60	69978		65	69979	
70	69980		75	69981	
80	69982				

taupe

25	62955		27,5	69939	
30	62956		32,5	69940	
35	62957		37,5	69941	
40	62958		42,5	69942	
45	62959		47,5	69943	
50	62960		55	62961	
60	62962		65	62963	
70	62964				

schwarz | black | noir | negro | nero | sort

25	62967		27,5	69944	
30	62968		32,5	69945	
35	62969		37,5	69946	
40	62970		42,5	69947	
45	62971		47,5	69948	
50	62972		55	62973	
60	62974		65	62975	
70	62976		75	62977	
80	62978				



water-repellent and adjustable
 wasserfester und verstellbarer
 Zwei-Wege-Reißverschluss
 für Geschirre*
 two-way-zipper for harnesses*

Hundemantel UPPSALA COZY

Dog coat | Manteau pour chiens | Abrigo para perros | Cappottino per cani | Hundefrakke

Polyester, wasserabweisend, wärmendes Plüsch-Innenfutter, reflektierend, wasserfester und verstellbarer Zwei-Wege-Reißverschluss auf der Oberseite für Geschirre, weitenregulierbarer Bauchgurt mit Klickverschluss, weitenregulierbarer Kragen, Öffnung zum Befestigen einer Leine am Halsband, elastische Fixiergummis für die Hinterläufe, variabel in der Länge, bei 30°C waschbar | *Polyester, water-repellent, warming plush lining, reflective, water-repellent and adjustable two-way zipper on the top side for harnesses, adjustable waist strap with click closing, adjustable collar, hole for securing a leash to the collar, elasticated rubber loops for the hind legs, length can be altered, washable at 30°C* | Polyester, hydrofuge, doublure intérieure chaude en peluche, réfléchissante, double fermeture zippée hydrofuge et ajustable sur la partie supérieure pour les harnais, sangle abdominale réglable en largeur avec fermeture à clic, col réglable en largeur, ouverture pour attacher une laisse au collier, élastiques de fixation aux pattes arrière, longueur variable, lavable à 30°C | *Poliéster, repelente al agua, relleno interior de felpa con efecto cálido, reflectante, cremallera doble repelente al agua y ajustable en la parte superior para arneses, ancho de cinturón regulable on cierre de clic, ancho de cuello regulable, orificio para fijar la correa en el collar, goma de fijación elástica para patas traseras, variable en longitud, lavable a 30°C* | Poliestere, etancheidrorepellente, fodera in caldo peluche, riflettente, cerniera bidirezionale idrorepellente e regolabile sulla parte superiore per pettorine, cinturino regolabile in vita con chiusura a scatto, colletto regolabile, apertura per fissare il guinzaglio al collare, nastri elastici di fissaggio per le zampe posteriori, Lunghezza variabile, lavabile a 30°C | *Polyester, vandafvisende, varmende plysfor, reflekterende, vandfast og indstillelig to-vejs lynlås på seletøjets overside, vidderegulerbar maverem med kliklukning, vidderegulerbar krave, åbning til fastgørelse af line på halsbåndet, elastisk fikseringsgummi til bagbenene, variabel i længde, vaskbar ved 30°C*

anthrazit/rot | anthracite/red | anthracite/rouge | anthracita/rojo | anthracite/rosso | antracit/rød

30	65428		35	65429	
40	65430		45	65431	
50	65432		55	65433	
60	65434				

anthrazit/petrol | anthracite/teal | anthracite/pétrole | anthracita/petróleo | anthracite/petrolio | antracit/petrol

30	65440		35	65441	
40	65442		45	65443	
50	65444		55	65445	
60	65446				

anthrazit/grau | anthracite/grey | anthracite/gris | anthracita/gris | anthracite/grigio | antracit/grå

30	65452		35	65453	
40	65454		45	65455	
50	65456		55	65457	
60	65458				

⇒	↔*	↔.
30	22 – 42 cm	33 – 62 cm
35	26 – 52 cm	42 – 75 cm
40	30 – 56 cm	51 – 88 cm
45	32 – 58 cm	54 – 92 cm
50	34 – 60 cm	57 – 97 cm
55	36 – 72 cm	62 – 108 cm
60	38 – 74 cm	66 – 114 cm



water-repellent and adjustable
 • wasserfester und verstellbarer
 Zwei-Wege-Reißverschluss
 für Geschirre*
 • two-way-zipper for harnesses*

2-IN-1

Hundemantel UPPSALA ALLROUNDER

Dog coat | Manteau pour chiens | Abrigo para perros | Cappottino per cani | Hundefrakke

Polyester, wasserabweisend, herausknöpfbares, wärmendes Innenfutter, reflektierend, wasserfester und verstellbarer Zwei-Wege-Reißverschluss auf der Oberseite für Geschirre, weitenregulierbarer Bauchgurt mit Klickverschluss, weitenregulierbarer Kragen, Öffnung zum Befestigen einer Leine am Halsband, elastische Fixiergummis für die Hinterläufe, variabel in der Länge, bei 30°C waschbar | Polyester, water-repellent, removable, warming inner lining, reflective, water-repellent and adjustable two-way zipper on the top side for harnesses, adjustable waist strap with click closing, adjustable collar, hole for securing a leash to the collar, elasticated rubber loops for the hind legs, length can be altered, washable at 30°C | Polyester, hydrofuge, doublure intérieure détachable et chauffante, réfléchissant, double fermeture zippée hydrofuge et ajustable sur la partie supérieure pour les harnais, sangle abdominale réglable en largeur avec fermeture à clic, col réglable en largeur, ouverture pour attacher une laisse au collier, élastiques de fixation aux pattes arrière, longueur variable, lavable à 30°C | Poliéster, repelente al agua, forro interior abrigado extraíble con botón, reflectante, cremallera doble repelente al agua y ajustable en la parte superior para arneses, ancho de cinturón regulable on cierre de clic, ancho de cuello regulable, orificio para fijar la correa en el collar, goma de fijación elástica para patas traseras, variable en longitud, lavable a 30°C | Poliester, etancheidrorepellente, rivestimento interno staccabile e riscaldante, riflettente, cerniera bidirezionale idrorepellente e regolabile sulla parte superiore per pettorine, cinturino regolabile in vita con chiusura a scatto, colletto regolabile, apertura per fissare il guinzaglio al collare, nastri elastici di fissaggio per le zampe posteriori, Lunghezza variabile, lavabile a 30°C | Polyester, vandafvisende, aftagelig, varmende foring, reflekterende, vandfast og indstillelig to-vejs lynlås på seletøjets overside, vidderegulerbar maverem med kliklukning, vidderegulerbar krave, åbning til fastgørelse af line på Halsbåndet, elastisk fikseringsgummi til bagbenene, variabel i længde, vaskbar ved 30°C



⇒	↔*	↔.
35	26 – 52 cm	42 – 75 cm
40	30 – 56 cm	51 – 88 cm
45	32 – 58 cm	54 – 92 cm
50	34 – 60 cm	57 – 97 cm
55	36 – 72 cm	62 – 108 cm



herausknöpfbares Futter
 lining can be removed

anthrazit/rot | anthracite/red | anthracite/rouge | anthracita/rojo | anthracite/rosso | antracit/rød

35	66236		40	66237	
45	66238		50	66239	
55	66240				

anthrazit/petrol | anthracite/teal | anthracite/pétrole | anthracita/petróleo | anthracite/petrolio | antracit/petrol

35	66827		40	66828	
45	66829		50	66830	
55	66831				



Hundemantel UPPSALA TREND

Dog coat | Manteau pour chiens | Abrigo para perros | Cappottino per cani | Hundefrakke

Baumwolle, wasserabweisend, trendiger Parkastil mit Lammfellimitat (Polyester) an der Innenseite, weitenregulierbarer Bauchgurt mit Klickverschluss, weitenregulierbarer Kragen, Öffnung zum Befestigen einer Leine am Halsband, elastische Fixiergummis für die Hinterläufe, variabel in der Länge, bei 30°C waschbar | *Cotton, water-repellent, trendy parker design with lambskin imitation lining (Polyester), adjustable waist strap with click closing, adjustable collar, hole for securing a leash to the collar, elasticated rubber loops for the hind legs, length can be altered, washable at 30°C* | Coton, hydrofuge, parka tendance avec imitation peau d'agneau (polyester) à l'intérieur, sangle abdominale réglable en largeur avec fermeture à clic, col réglable en largeur, ouverture pour attacher une laisse au collier, élastiques de fixation aux pattes arrière, longueur variable, lavable à 30°C | *Algodón, repelente al agua, parka con imitación de piel de cordero (Poliéster) en el interior, ancho de cinturón regulable on cierre de clic, ancho de cuello regulable, orificio para fijar la correa en el collar, goma de fijación elástica para patas traseras, variable en longitud, lavable a 30°C* | Cotone, idrorepellente, stile parker con l'imitazione della pelle d'agnello (Poliestere) all'interno, cinturino regolabile in vita con chiusura a scatto, colletto regolabile, apertura per fissare il guinzaglio al collare, nastri elastici di fissaggio per le zampe posteriori, Lunghezza variabile, lavabile a 30°C | *Bomuld, vandafuisende, trendy parkastil med imiteret lammeskind (Polyester) på indersiden, vidderegulerbar maverem med kliklukning, vidderegulerbar krave, åbning til fastgørelse af line på Halsbåndet, elastisk fikseringsgummi til bagbenene, variabel i længde, vaskbar ved 30°C*

khaki | kaki | kaki | caqui | cachi | kaki

↕	↔	↔
30	22 – 40 cm	36 – 60 cm
35	26 – 42 cm	48 – 66 cm
40	30 – 56 cm	56 – 80 cm
45	32 – 58 cm	58 – 84 cm
50	34 – 60 cm	60 – 92 cm
55	36 – 72 cm	66 – 102 cm
60	38 – 74 cm	70 – 104 cm
65	40 – 76 cm	72 – 112 cm

30	66223		35	66224	
40	66225		45	66226	
50	66227		55	66228	
60	66229		65	66230	









Schlafplätze

— Beds —

Das sprichwörtliche »Hundemüde Sein« kommt wohl nicht von ungefähr. Denn der Hund an sich hat ein ausgeprägtes Schlafbedürfnis, das das menschliche Pensum bei Weitem übersteigt. Umso wichtiger ist, dass Ihr Vierbeiner einen gemütlichen Rückzugsort hat, an dem er sich entspannen kann. Daher stellt HUNTER auch im Kissen- und Betten-Sortiment höchste Anforderungen an die Qualität der Produkte. Egal ob kuschelig weich mit Plüschbesatz oder pflegeleicht und funktional – hier ist für jeden Hund der passende Schlafplatz dabei!

There is a reason we call it being dog tired – dogs need considerably more sleep than people. So it is essential that your four-legged friend has a cosy place to rest and relax. Which is why HUNTER's range of cushions and beds meets the highest quality standards. Whether cuddly and soft with plush trim or easy to clean and functional – we have the perfect bed for every dog.



⇒  
 XXL 140 x 100 cm 4 Stck. | pcs.

Hundedecke CASPER

Dog blanket | Couverture pour chiens | Manta de perro | Coperta per cani | Hundeteppe

Polyester, bei 30°C waschbar | *Polyester, washable at 30°C* | Polyester, lavable à 30°C | *Poliéster, lavable a 30°C* | Poliestere, lavabile a 30°C | *Polyester, vaskbar ved 30°C*

creme | cream | crème | crema | crema | creme

XXL 69733 

blau | blue | bleu | azul | blu | blå

XXL 69731 



grün | green | vert | verde | verde | grøn

XXL 69732 

anthrazit | anthracite | anthracite | anthracita | anthracite | antracit

XXL 67705 



 
 35 x 75 x 35 cm 24/Display

Bodendisplay Hundedecke CASPER

Dog blanket | Couverture pour chiens | Manta de perro | Coperta per cani | Hundeteppe

Polyester, bei 30°C waschbar | *Polyester, washable at 30°C* | Polyester, lavable à 30°C | *Poliéster, lavable a 30°C* | Poliestere, lavabile a 30°C | *Polyester, vaskbar ved 30°C*

69859 





Schmutzfang-Hundematte WATERLOO

Brush mat for dogs | Tapis pour chien antialisurre | Alfombrilla atrapasuciedad para perros | Tappetino cattura-sporco per cani | Snavsfenger-hundemåtte

Polyester/TPR, hochwertige, wasserdichte und rutschhemmende Unterseite aus TPR, gute Aufnahme von Schmutz, schützt den Boden vor Schmutz und Nässe, schnelltrocknend, sehr saugfähig, bei 40°C waschbar | *Polyester/TPR, high-quality, waterproof and non-slip bottom made of TPR, good absorption of dirt, protects the floor from dirt and moisture, fast drying, very absorbent, washable at 40°C* | Polyester/TPR, dessous de haute qualité, imperméable et antidérapant en TPR, bonne absorption de la saleté, protège le sol contre la saleté et l'humidité, séchage rapide, très absorbant, lavable à 40°C | *Poliéster/TPR, de alta calidad, a prueba de agua y antideslizante de la parte inferior de TPR, buena absorción de la suciedad, protege el suelo de la suciedad y la humedad, de secado rápido, muy absorbente, lavable a 40°C* | Poliestere/TPR, lato inferiore di alta qualità, impermeabile e antiscivolo in TPR, buon assorbimento dello sporco, protegge il pavimento dallo sporco e dall'umidità, asciugatura rapida, molto assorbente, lavabile a 40°C | *Polyester/TPR, høj kvalitet, vandtæt og skridsikker bund lavet af TPR, god optagelse af snavs, beskytter gulvet mod snavs og fugt, hurtigtørrende, meget absorberende, vaskbar ved 40°C*

rot | red | rouge | rojo | rosso | rød

S 69633  M 69634 

hellbraun | light brown | marron clair | marrón claro | marrone chiaro | lysebrun

S 69630  M 69631 

L 69632 

grau | grey | gris | gris | grigio | grå

S 69627  M 69628 

L 69629 

anthrazit | anthracite | anthracite | anthracita | anthracite | antracit

S 67768  M 67769 

L 67770  XL 69465 

XXL 69466 



Größe	Maße
S	60 x 40 cm
M	80 x 60 cm
L	90 x 60 cm
XL	100 x 70 cm
XXL	120 x 80 cm

Dank der wasserdichten und rutschhemmenden Unterseite aus TPR (Thermoplastisches Gummi) bleibt WATERLOO zuverlässig an der gewünschten Stelle liegen bis der Vierbeiner trocken und sauber ist.

Thanks to the waterproof and anti-slip underside made of TPR (thermoplastic rubber), WATERLOO reliably stays in place until the quadruped is dry and clean.





↗	■
M	75 x 55 cm
L	105 x 70 cm
XL	120 x 70 cm

Hundematte FULLY

Dog mat | Tapis pour chiens | Alfombra para perros | Tappeto per cani | Hundemätte

Polyester, rutschhemmende Unterseite, bei 30°C waschbar | *Polyester, non-slip bottom, washable at 30°C* | Polyester, partie inférieure antidérapante, lavable à 30°C | *Poliéster, base antideslizante, lavable a 30°C* | Poliestere, fondo antiscivolo, lavabile a 30°C | *Polyester, skridsikker bund, vaskbar ved 30°C*

braun | brown | marron | marrón | marrone | brun

M 67537  L 67538 

XL 67539 

schwarz | black | noir | negro | nero | sort

M 67534  L 67535 

XL 67536 



SUPER SOFT



⇒	■
L	100 x 70 cm

Hundedecke KONSTANZ

Dog blanket | Couverture pour chiens | Manta de perro | Coperta per cani | Hundeteppe

Polyester, bei 30°C waschbar | *Polyester, washable at 30°C* | Polyester, lavable à 30°C | *Poliéster, lavable a 30°C* | Poliestere, lavabile a 30°C | *Polyester, vaskbar ved 30°C*

braun | brown | marron | marrón | marrone | brun

L 65093 

schwarz | black | noir | negro | nero | sort

L 65091 





■
145 x 150 cm



■
100 x 65 cm

Rückbank-Schutzdecke HAMILTON

Rear seat cover | Couverture de protection pour siège arrière | Manta para el coche (asiento trasero) | Coperta coprisedile per sedili posteriori | Skånebetræk til bilens bagsæde

Polyester/Baumwolle, Sitzfläche mit Polyester-Füllung, verstellbare Gurte zum Anbringen an den Kopfstützen, schützt das Auto vor Schmutz und Haaren, mit Schlitz für Autosicherheitsgeschirre, mit praktischer Tasche, waschbar bei 95 °C | *Polyester/Cotton, cushioned with polyester filling, adjustable belts for fastening to the headrests, protects the car from dirt and hair, with slits for car seatbelts, with practical bag, washable at 95 °C* | Polyester/coton, siège rembourré de polyester, sangles réglables pour fixation aux appuis-tête, protège la voiture de la saleté et des poils, avec fentes pour les harnais de sécurité pour automobile, poches pratiques, lavable à 95 °C | *Poliéster/algodón, asiento con relleno de poliéster, correas ajustables para fijar a los reposacabezas, protege el coche de suciedad y pelos, con ranuras para arneses de coches, con un práctico bolsillo, lavable a 95 °C* | Poliestere/cotone, superficie di seduta con imbottitura in poliester, cinghie regolabili per il fissaggio ai poggiatesta, protegge l'auto da sporco e capelli, con fessure per le cinture di sicurezza, con pratica tasca, lavabile a 95 °C | *Polyester/Bomuld, Sideflade med polyesterfyld, indstillelige remme til anbringelse på nakkestøtterne, beskytter bilen mod snavs og hård, med slider til bilens sikkerhedsseler, med praktisk lomme, kan vaskes ved 95 °C*

schwarz | black | noir | negro | nero | sort

68197 

Kofferraum-Schutzdecke HAMILTON

Car blanket for protection for the trunk | Couverture de protection pour le coffre de la voiture | Manta de protección para el maletero del coche | Coperta protettiva per portabagagli | Teppe til bagagerum

Polyester/Baumwolle, Sitzfläche mit Polyester-Füllung, verstellbare Gurte zum Anbringen an den Kopfstützen, schützt den Kofferraum vor Schmutz und Haaren, waschbar bei 95 °C | *Polyester/Cotton, cushioned with polyester filling, adjustable belts for fastening to the headrests, protects the car boot from dirt and hair, washable at 95 °C* | Polyester/coton, siège rembourré de polyester, sangles réglables pour fixation aux appuis-tête, protège le coffre de la saleté et des poils, lavable à 95 °C | *Poliéster/algodón, asiento con relleno de poliéster, correas regulables para fijar a los reposacabezas, protege el maletero de suciedad y pelos, lavable a 95 °C* | Poliestere/cotone, superficie di seduta con imbottitura in poliester, cinghie regolabili per il fissaggio ai poggiatesta, protegge il portabagagli da sporco e capelli, lavabile a 95 °C | *Polyester/Bomuld, Sideflade med polyesterfyld, indstillelige gjorde til anbringelse på nakkestøtterne, beskytter bagagerummet mod snavs og hård, kan vaskes ved 95 °C*

schwarz | black | noir | negro | nero | sort

68196 



XXL
120 x 70 cm

■
120 x 70 cm

Hundedecke HAMILTON

Dog blanket | Couverture pour chiens | Manta de perro | Coperta per cani | Hundetæppe

Baumwolle / Polyester, bei 95°C waschbar | *Cotton / Polyester, washable at 95°C* | Coton / Polyester, lavable à 95°C | *Algodón / Poliéster, lavable a 95°C* | Cotone / Poliestere, lavabile a 95°C | *Bomuld / Polyester, vaskbar ved 95°C*

grau | grey | gris | gris | grigio | grå

66220 



Der besondere Clou dieser Hundedecke: Sie ist bei 95 °C waschbar. Durch die Kochwäsche werden alle Keime und Parasiten (Hausstaubmilben o.ä.) zuverlässig aus dem Inneren des Gewebes ausgewaschen und abgetötet. Das sorgt für ultimative Reinheit und Hygiene. Darüber hinaus sorgt das Baumwollmischgewebe für eine weiche Unterlage, die außerdem noch strapazierfähig und pflegeleicht ist. Ein gemütlicher, universell einsetzbarer und leicht zu verstauender Allrounder für jede Gelegenheit.

The special highlight of this dog blanket: it is washable at 95 °C. A high-temperature wash will reliably remove all germs and parasites (dust mites and similar creatures) from the blanket's interior and kill them. This ensures optimal cleanliness and hygiene. What's more, the cotton blend creates a soft surface that is also durable and easy to clean. A comfy all-rounder that can be used anywhere at any time and is easy to store.

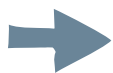

hygienisch
hygienic



robust
durable



universell einsetzbar
universally usable





↗	■
XS	60 x 40 cm
S	70 x 50 cm
M	90 x 60 cm
L	100 x 80 cm
XL	120 x 100 cm

Hundematte VERMONT

Dog mat | Tapis pour chiens | Alfombra para perros | Tappeto per cani | Hundemätte

Polyester, Füllung (Polyester/ Schaumstoff), rutschhemmende Unterseite, bei 30°C waschbar | Polyester, polyester/ foam filling, non-slip bottom, washable at 30°C | Polyester, rembourrage (polyester/ mousse), partie inférieure antidérapante, lavable à 30°C | Poliéster, relleno (poliéster/ espuma), base antideslizante, lavable a 30°C | Poliestere, l'imbottitura (poliestere/ schiuma), fondo antiscivolo, lavabile a 30°C | Polyester, fylld (polyester/ skum), skridsikker bund, vaskbar ved 30°C

grau | grey | gris | gris | grigio | grå

XS	65063		S	65064	
M	65065		L	65053	
XL	65054				

schwarz | black | noir | negro | nero | sort

XS	65066		S	65067	
M	65068		L	65055	
XL	65056				



↗	■
S	60 x 40 cm
M	70 x 50 cm
L	90 x 60 cm
XL	100 x 80 cm

Hundematte VERMONT COZY

Dog mat | Tapis pour chiens | Alfombra para perros | Tappeto per cani | Hundemätte

Polyester, Füllung (Polyester), sehr weicher Plüsch, rutschhemmende Unterseite, bei 30°C waschbar | Polyester, Polyester filling, very soft plush, non-slip bottom, washable at 30°C | Polyester, rembourrage (polyester), peluche très douce, partie inférieure antidérapante, lavable à 30°C | Poliéster, relleno (poliéster), felpa muy suave, base antideslizante, lavable a 30°C | Poliestere, l'imbottitura (poliestere), felpato molto morbido, fondo antiscivolo, lavabile a 30°C | Polyester, fylld (polyester), meget blødt plys, skridsikker bund, vaskbar ved 30°C

beige | tan | beige | beige | beige | beige

S	65709		M	65710	
L	65711		XL	65712	

grau | grey | gris | gris | grigio | grå

S	65705		M	65706	
L	65707		XL	65708	



Ø
55 cm

Hunde- und Katzenschlafplatz LUGANO

Dog and cat bed | Caverne pour chiens et chats | Cama para perros y gatos | Cuccetta per cani e gatti | Hunde- og kattesoveplads

Polyester, sehr weicher Plüsch, wendbares Innenkissen, faltbar auch als Bett benutzbar, Handwäsche | *Polyester, very soft plush, reversible inner cushion, folds to also use as a bed, hand wash* | Polyester, peluche très douce, coussin intérieur réversible, pliable et peut également être utilisé comme lit, lavage à la main | *Poliéster, felpa muy suave, cojín interior reversible, plegable para usarse también como cama, lavar a mano* | Poliestere, felpato molto morbido, cuscino interno double face, pieghevole e utilizzabile anche come letto, lavaggio a mano | *Polyester, meget blødt plys, vendbar inderpude, sammenfoldelig også anvendelig som seng, håndvask*

anthrazit | anthracite | anthracite | anthracita | anthracite | antracit

65269 



Ø
50 cm

Hunde- und Katzenschlafplatz SAMARA

Dog and cat bed | Caverne pour chiens et chats | Cama para perros y gatos | Cuccetta per cani e gatti | Hunde- og kattesoveplads

Polyester, Handwäsche | *Polyester, hand wash* | Polyester, lavage à la main | *Poliéster, lavar a mano* | Poliestere, lavaggio a mano | *Polyester, håndvask*

anthrazit | anthracite | anthracite | anthracita | anthracite | antracit

67688 



Ø
50 cm

Hunde- und Katzenschlafplatz MIRANDA

Dog and cat bed | Caverne pour chiens et chats | Cama para perros y gatos | Cuccetta per cani e gatti | Hunde- og kattesoveplads

Polyester, Füllung: Polyester, bei 30°C waschbar | *Polyester, filling: polyester, washable at 30°C* | Polyester, remplissage: polyester, lavable à 30°C | *Poliéster, relleno: poliéster, lavable a 30°C* | Poliestere, imbottitura: poliestere, lavabile a 30°C | *Polyester, fylde: polyester, vaskbar ved 30°C*

grau | grey | gris | gris | grigio | grå

67651 

anthrazit | anthracite | anthracite | anthracita | anthracite | antracit

67652 

SUPER SOFT



⇒	Ø
S	50 cm
M	60 cm

Hunde- und Katzenschlafplatz LOPPA

Dog and cat bed | Caverne pour chiens et chats | Cama para perros y gatos | Cuccetta per cani e gatti | Hunde- og kattesoveplads

Polyester, sehr weiches Plüsch, Füllung (Polyester) kann dank Reißverschlüssen komplett entnommen werden, rutschhemmende Unterseite, Bezug bei 30°C waschbar | *Polyester, very soft plush, Polyester filling can be completely removed using the zippers, non-slip bottom, cover washable at 30°C* | Polyester, peluche très douce, rembourrage (polyester) complètement amovible grâce à des fermetures éclair, partie inférieure antidérapante, housse lavable à 30°C | *Poliéster, felpa muy suave, relleno (poliéster) puede extraerse por completo gracias a su cremallera, base antideslizante, funda lavable a 30°C* | Poliestere, felpato molto morbido, l'imbottitura (poliestere) si può rimuovere completamente grazie alle cerniere incluse, fondo antiscivolo, federa lavabile a 30°C | *Polyester, meget blødt plys, fyld (polyester) kan tages helt ud ved hjælp af lynlåsen, skridsikker bund, betæk vaskbar ved 30°C*

weiß | white | blanc | blanco | bianco | hvid

S 68672  M 68673 

anthrazit | anthracite | anthracite | anthracita | anthracite | antracit

S 68674  M 68675 



Extrem weich
und flauschig
Especially soft and fluffy



Rockford-Family

Orthopädisches Hundesofa ROCKFORD

Orthopaedic dog sofa | Sofa orthopédique pour chiens | Sofá ortopédico para perros | Divano ortopedico per cani | Ortopædisk hundesofa

Polyester, sehr weicher Plüsch, Füllung (Polyester/ Liegefläche Memoryschaum) kann dank Reißverschlüssen komplett entnommen werden, wendbares Innenkissen, rutschhemmende Unterseite, optimal für ältere Hunde oder solche mit Erkrankungen des Bewegungsapparates, Bezug bei 30°C waschbar | Polyester, very soft plush, filling (polyester/ lying surface memory foam) can be completely removed thanks to zips, reversible inner cushion, non-slip underside, ideal for older dogs or those with musculoskeletal disorders, cover washable at 30°C | Polyester, peluche très douce, rembourrage (polyester/ surface e couchage mousse à mémoire de forme) peut être entièrement retiré grâce à des fermetures éclair, coussin intérieur réversible, partie inférieure antidérapante, optimal pour les chiens âgés ou ceux souffrant de maladies de l'appareil locomoteur, housse lavable à 30 °C | Poliéster, felpa muy suave, relleno (poliéster/ superficie tumbada espuma viscoelástica) totalmente desmontable gracias a las cremalleras, cojín interior reversible, base antideslizante, ideal para perros mayores o con trastornos musculoesqueléticos, funda lavable a 30°C | Poliester, felpato molto morbido, imbottitura (poliester/ superficie di appoggio memory foam) completamente rimovibile grazie alle cerniere, cuscino interno double face, fondo antiscivolo, ideale per cani anziani o con disturbi muscoloscheletrici, rivestimento lavabile a 30 °C | Polyester, meget blødt phys, fyld (polyester/ liggende overflade hukommelseskum) kan fjernes helt takket være lynlåse, vendbar inderpude, skridsikker bund, ideel til ældre hunde eller hunde med lidelser i bevægeapparatet, betræk kan vaskes ved 30 °C

beige | tan | beige | beige | beige

S 200238  M 200240 

L 200242  XL 201868 

braun | brown | marron | marrón | marrone | brun

S 200244  M 200246 

L 200248  XL 201869 

anthrazit/hellgrau | anthracite/light grey | anthracite/gris clair | anthracita/gris claro | anthracite/grigio chiaro | antracit/lysegrå

S 200232  M 200234 

L 200236  XL 201867 



budget friendly
Preis STARK

↕	📏
S	60 x 40 cm
M	80 x 60 cm
L	100 x 70 cm
XL	120 x 90 cm

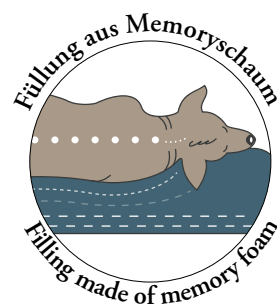

Rockford-Family

Hunde- und Katzenschlafplatz ROCKFORD

Dog and cat bed | Caverne pour chiens et chats | Cama para perros y gatos | Cuccetta per cani e gatti | Hunde- og kattesoveplads

Polyester, sehr weicher Plüsch, wendbares Innenkissen, rutschhemmende Unterseite, bei 30°C waschbar | *Polyester, very soft plush, reversible inner cushion, non-slip bottom, washable at 30°C* | Polyester, peluche très douce, coussin intérieur réversible, partie inférieure antidérapante, lavable à 30 °C | *Poliéster, felpa muy suave, cojín interior reversible, base antideslizante, lavable a 30 °C* | Poliestere, felpato molto morbido, cuscino interno double face, fondo antiscivolo, lavabile a 30 °C | *Polyester, meget blødt plys, vendbar inderpude, skridsikker bund, vaskbar ved 30 °C*

beige | tan | beige | beige | beige | beige

S 200310  M 200312 

L 200314 

braun | brown | marron | marrón | marrone | brun

S 200316  M 200318 

L 200320 

anthrazit/hellgrau | anthracite/light grey | anthracite/gris clair | anthracita/gris claro | anthracite/grigio chiaro | antracit/lysegrå

S 200304  M 200306 

L 200308 



DONUT



budget friendly
Preis STARK

↕	Ø
S	50 cm
M	70 cm
L	90 cm

Rockford-Family

Hundekissen ROCKFORD

Dog cushion | Coussin pour chiens | Cojín para perro | Cuscino per cani | Hundepude

Polyester, sehr weicher Plüsch, wendbar, bei 30°C waschbar | *Polyester, very soft plush, reversible, washable at 30 °C* | Polyester, peluche très douce, réversible, lavable a 30 °C | *Poliéster, felpa muy suave, reversible, lavable a 30 °C* | Poliestere, felpato molto morbido, double face, lavabile a 30 °C | *Polyester, meget blødt plys, vendbar, vaskbar ved 30 °C*

beige | tan | beige | beige | beige | beige

M 200292  L 200294 

XL 200296 

braun | brown | marron | marrón | marrone | brun

M 200298  L 200300 

XL 200302 

anthrazit/hellgrau | anthracite/light grey | anthracite/gris clair | anthracita/gris claro | anthracite/grigio chiaro | antracit/lysegrå

M 200286  L 200288 

XL 200290 

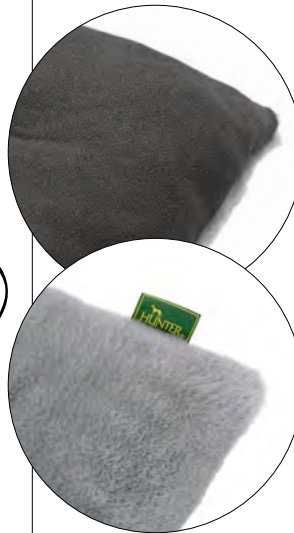

budget friendly
Preis STARK

	⇒	▣
M		80 x 60 x 12 cm
L		100 x 70 x 14 cm
XL		120 x 80 x 16 cm



Rockford-Family**Hundematte ROCKFORD**

Dog mat | Tapis pour chiens | Alfombra para perros | Tappeto per cani | Hundemätte

Polyester, sehr weicher Plüsch, wendbar, bei 30°C waschbar | *Polyester, very soft plush, reversible, washable at 30 °C* | Polyester, peluche très douce, réversible, lavable a 30 °C | *Poliéster, felpa muy suave, reversible, lavable a 30 °C* | Poliestere, felpato molto morbido, double face, lavabile a 30 °C | *Polyester, meget blødt plys, vendbar, vaskbar ved 30 °C*

beige | tan | beige | beige | beige | beige

XS 200262  S 200264 

M 200266  L 200268 

XL 200270  XXL 200272 

braun | brown | marron | marrón | marrone | brun

XS 200274  S 200276 

M 200278  L 200280 

XL 200282  XXL 200284 

anthrazit/hellgrau | anthracite/light grey | anthracite/gris clair | anthracita/gris claro | anthracite/grigio chiaro | antracit/lysegrå

XS 200250  S 200252 

M 200254  L 200256 

XL 200258  XXL 200260 

budget friendly
**Preis
STARK**

XXL
130 x 90 cm



↗	■
XS	50 x 35 x 5 cm
S	60 x 45 x 5 cm
M	75 x 55 x 5 cm
L	90 x 65 x 5 cm
XL	110 x 70 x 5 cm
XXL	130 x 90 x 5 cm

Hundekissen
Dog cushion

Hundematte
Dog mat



Rockford-Family

Polster-Schondecke ROCKFORD

Sofa cover | Couverture de protection pour canapés | Funda protectora para sofás | Copertura protettiva per divani | Beskyttelsesbetræk til sofaer

Polyester, sehr weicher Plüsch, schützt das Sofa vor Haaren und Schmutz, mit Rand zur Begrenzung und zum Einkuscheln, bei 30°C waschbar | Polyester, very soft plush, protects the sofa from hair and dirt, with edge for bordering and snuggling in, washable at 30°C | Polyester, peluche très douce, protège le canapé des cheveux et de la saleté, avec bord pour le délimiter et s'y blottir, lavable a 30 °C | Poliéster, felpa muy suave, protege el sofá del pelo y la suciedad, con borde para bordearlo y acurrucarse en él, lavable a 30 °C | Poliestere, felpato molto morbido, protegge il divano da peli e sporcizia, con un bordo per accostarlo e accoccolarlo, lavabile a 30 °C | Polyester, meget blødt plys, beskytter sofaen mod hår og snavs, med kant til at omslutte og putte sig i, vaskbar ved 30 °C

beige | tan | beige | beige | beige | beige

L 200326  XL 200328 

braun | brown | marron | marrón | marrone | brun

L 200330  XL 200332 

anthrazit/hellgrau | anthracite/light grey | anthracite/gris clair | anthracita/gris claro | anthracite/grigio chiaro | antracit/lysegrå

L 200322  XL 200324 





budget friendly
Preis STARK



⇒ 
L 90 x 70 cm
XL 120 x 100 cm



 **Schützt Polster vor Haaren und Schmutz**
Protects upholstery from hair and dirt

 **Gepolsterter Rand zur Begrenzung und zum Einkuscheln**
Padded edge for bordering and snuggling in

 **Liegefläche mit sehr weichem und kuscheligem Plüsch**
Lying surface with very soft and cosy plush

Rockford-Family

Kissen und Hundedecke 2in1 ROCKFORD

Pillow and dog blanket 2in1 | Coussin et couverture pour chien 2en1 | Almohada y manta para perro 2en1 | Cuscino e coperta per cani 2in1 | Pude og hundeteppe 2i1

Polyester, Oberseite mit sehr weichem Plüsch, kann bei Nichtgebrauch in der Hülle verstaut und als Deko- und Kuschelkissen genutzt werden, bei 30°C waschbar | *Polyester, top side with very soft plush, can be stored in the cover when not in use and used as a decorative and cosy cushion, washable at 30°C* | Polyester, face supérieure en peluche très douce, peut être rangé dans la housse lorsqu'il n'est pas utilisé et servir de coussin décoratif ou douillet, lavable à 30°C | *Poliéster, cara superior con felpa muy suave, se puede guardar en la funda cuando no se usa y utilizar como cojín decorativo y acogedor, lavable a 30°C* | Poliestere, lato superiore in morbidissimo peluche, può essere riposto nella fodera quando non viene utilizzato e usato come cuscino decorativo e accogliente, lavabile a 30°C | *Polyester, overside med meget blødt plys, kan opbevares i betrækket, når det ikke er i brug, og bruges som en dekorativ og hyggelig pude, kan vaskes ved 30 °C*

braun | brown | marron | marrón | marrone | brun

XL 204812 

anthrazit/hellgrau | anthracite/light grey | anthracite/gris clair | anthracita/gris claro | anthracite/grigio chiaro | antracit/lysegrå

XL 204810 



⇒  XL 120 x 80 cm

Verwandle die Hundedecke bei Bedarf zu einem schicken Deko-Kissen!
Transform the dog blanket into a chic decorative cushion!





NEW SIZE

Rockford-Family**Hunde-Reisedecke ROCKFORD**

Travel blanket for dogs | Couverture de voyage pour chiens | Manta de viaje para perros | Coperta da viaggio per cani | Hund rejse tæppe

Polyester, Oberseite mit sehr weichem Plüsch, kann zusammengerollt, durch Klettstreifen fixiert und platzsparend transportiert werden, mit Tragegriff, bei 30°C waschbar | *Polyester, top side with very soft plush, can be rolled up, secured with velcro and easily transported, with handle, washable at 30°C* | Polyester, face supérieure en peluche très douce, peut être roulée sur elle-même, fixée avec du velcro et transporter de manière peu encombrante, avec poignée, lavable à 30 °C | *Poliéster, top con felpa muy suave, se puede enrollar, fijar con velcro y transportar ahorrando espacio, con asa, lavable a 30 °C* | Poliestere, top in felpato molto morbido, può essere arrotolata, fissato con cinghie di velcro e trasportato con un minimo ingombro, con maniglia, lavabile a 30°C | *Polyester, top med meget blødt plys, kan rulles sammen, fastgøres med velcrobånd og transporteres på en pladsbesparende måde, med håndtag, vaskbar ved 30 °C*

anthrazit/hellgrau | anthracite/light grey | anthracite/gris clair | anthracite/gris claro | anthracite/grigio chiaro | antracit/lysegrå

L 69854



XL 200334



↕	☐
L	100 x 70 cm
XL	120 x 80 cm





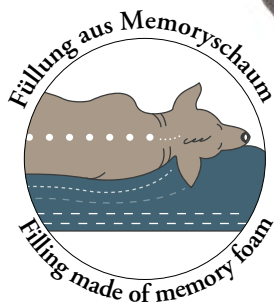

⇒	■
S	60 x 40 cm
M	80 x 60 cm
L	100 x 70 cm
XL	120 x 90 cm

Orthopädisches Hundesofa SEATTLE

Orthopaedic dog sofa | Sofa orthopédique pour chiens | Sofá ortopédico para perros | Divano ortopedico per cani | Ortópædisk hundesofa

Polyester, Füllung (Polyester/ Liegefläche Memoryschaum) kann dank Reißverschlüssen komplett entnommen werden, wendbares Innenkissen, rutschhemmende Unterseite, optimal für ältere Hunde oder solche mit Erkrankungen des Bewegungsapparates, Bezug bei 40°C waschbar | Polyester, filling (polyester/ lying surface memory foam) can be completely removed thanks to zips, reversible inner cushion, non-slip underside, ideal for older dogs or those with musculoskeletal disorders, cover washable at 40 °C | Polyester, rembourrage (polyester/ surface e couchage mousse à mémoire de forme) peut être entièrement retiré grâce à des fermetures éclair, coussin intérieur réversible, dessous antidérapant, optimal pour les chiens âgés ou ceux souffrant de maladies de l'appareil locomoteur, housse lavable à 40 °C | Poliéster, relleno (poliéster/ superficie tumbada espuma viscoelástica) totalmente desmontable gracias a las cremalleras, cojín interior reversible, parte inferior antideslizante, ideal para perros mayores o con trastornos musculoesqueléticos, funda lavable a 40 °C | Poliestere, imbottitura (poliestere/ superficie di appoggio memory foam) completamente rimovibile grazie alle cerniere, cuscino interno double face, lato inferiore antiscivolo, ideale per cani anziani o con disturbi muscoloscheletrici, rivestimento lavabile a 40 °C | Polyester, fylld (polyester/ liggende overflade hukommelseskum) kan fjernes helt takket være lynlåse, vendbar inderpude, skridsikker underside, ideel til ældre hunde eller hunde med lidelser i bevægeapparatet, betræk kan vaskes ved 40 °C

beige | tan | beige | beige | beige | beige

S	69856		M	69857	
L	69858		XL	201870	

grau | grey | gris | gris | grigio | grå

S	69919		M	69920	
L	69921		XL	201871	



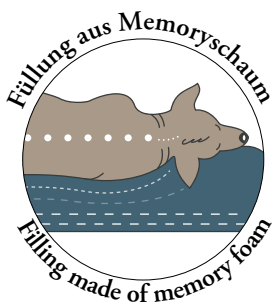

↔	Ø
S	50 cm
M	70 cm
L	90 cm

Orthopädischer Hunde- und Katzenschlafplatz SEATTLE

Orthopaedic Dog and cat bed | Sofa orthopédique pour chiens et chats | Cama ortopédica para perros y gatos | Letto ortopedico per cani e gatti | Ortopadisk hunde- og katteseng

Polyester, Füllung des wendbaren Liegekissens (Memoryschaum) kann dank Reißverschlüssen komplett entnommen werden, rutschhemmende Unterseite, optimal für ältere Tiere oder solche mit Erkrankungen des Bewegungsapparates, Bezug bei 30°C waschbar | *Polyester, filling of the reversible reclining cushion (memory foam) can be completely removed thanks to zips, non-slip underside, ideal for older animals or those with musculoskeletal disorders, cover washable at 30°C* | Polyester, le remplissage du coussin réversible (mousse à mémoire de forme) peut être entièrement retiré grâce à des fermetures éclair, dessous antidérapant, optimal pour les animaux âgés ou souffrant de maladies de l'appareil locomoteur, housse lavable à 30°C | *Poliéster, relleno del cojín reclenable reversible (espuma viscoelástica) totalmente extraíble gracias a las cremalleras, parte inferior antideslizante, ideal para animales mayores o con trastornos musculoesqueléticos, funda lavable a 30°C* | Poliester, l'imbottitura del cuscino reclinabile reversibile (memory foam) può essere completamente rimossa grazie alle cerniere, lato inferiore antiscivolo, ideale per animali anziani o con disturbi muscolo-scheletrici, rivestimento lavabile a 30°C | *Polyester, fyldet i den vendbare liggepude (memory foam) kan tages helt ud takket være lynlåse, skridsikker underside, ideel til ældre dyr eller dyr med lidelser i bevægeapparatet, betræk kan vaskes ved 30°C*

beige | tan | beige | beige | beige | beige

S 200396

M 200398

L 200400

grau | grey | gris | gris | grigio | grå

S 200402

M 200404

L 200406

budget friendly
Preis STARK





budget friendly
Preis STARK

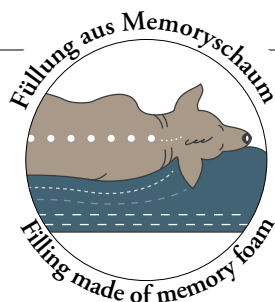

↯	▣
S	60 x 40 cm
M	80 x 60 cm
L	100 x 70 cm
XL	120 x 90 cm

Orthopädisches Hundesofa CLEVELAND

Orthopaedic dog sofa | Sofa orthopédique pour chiens | Sofá ortopédico para perros | Divano ortopedico per cani | Ortopædisk hundesofa

Polyester, Füllung (Polyester/ Liegefläche Memoryschaum) kann dank Reißverschlüssen komplett entnommen werden, wendbares Innenkissen, rutschhemmende Unterseite, optimal für ältere Hunde oder solche mit Erkrankungen des Bewegungsapparates, wasserabweisend, Bezug bei 40°C waschbar | *Polyester, filling (polyester/ lying surface memory foam) can be completely removed thanks to zips, reversible inner cushion, non-slip underside, ideal for older dogs or those with musculo-skeletal disorders, water-repellent, cover washable at 40°C* | Polyester, rembourrage (polyester/ surface e couchage mousse à mémoire de forme) peut être entièrement retiré grâce à des fermetures éclair, coussin intérieur réversible, dessous antidérapant, optimal pour les chiens âgés ou ceux souffrant de maladies de l'appareil locomoteur, hydrofuge, housse lavable à 40°C | *Poliéster, relleno (poliéster/ superficie tumbada espuma viscoelástica) totalmente desmontable gracias a las cremalleras, cojín interior reversible, parte inferior antideslizante, ideal para perros mayores o con trastornos musculoesqueléticos, repele al agua, funda lavable a 40°C* | Poliestere, imbottitura (poliestere/ superficie di appoggio memory foam) completamente rimovibile grazie alle cerniere, cuscino interno double face, lato inferiore antiscivolo, ideale per cani anziani o con disturbi muscoloscheletrici, idrorepellente, rivestimento lavabile a 40°C | *Polyester, fýld (polyester/ liggende overflade hukommelseskum) kan fjernes helt takket være lynlåse, vendbar inderpude, skridsikker underside, ideel til ældre hunde eller hunde med lidelser i bevøgeapparatet, vandafvisende, betræk kan vaskes ved 40°C*

bordeauxrot | bordeaux red | rouge bordeaux | rojo bordeaux | rosso bordeaux | bordeaux rød

S 206921 M 206923

L 206925

grün | green | vert | verde | verde | grøn

S 206927 M 206929

L 206931

grau | grey | gris | gris | grigio | grå

S 69848 M 69849

L 69850 XL 201866

anthrazit | anthracite | anthracite | anthracita | anthracite | antracit

S 206913 M 206915

L 206917 XL 206919





Hundesofa BOSTON

Dog sofa | Sofa pour chiens | Sofá para perros | Divano per cani | Hundesofa

Polyester, Füllung (Polyester) kann dank Reißverschlüssen komplett entnommen werden, wendbares Innenkissen, rutschhemmende Unterseite, Bezug bei 30°C waschbar | *Polyester, Polyester filling can be completely removed using the zippers, reversible inner cushion, non-slip bottom, cover washable at 30°C* | Polyester, rembourrage (polyester) complètement amovible grâce à des fermetures éclair, coussin intérieur réversible, partie inférieure antidérapante, housse lavable à 30°C | *Poliéster, relleno (poliéster) puede extraerse por completo gracias a su cremallera, cojín interior reversible, base antideslizante, funda lavable a 30°C* | Poliestere, l'imbottitura (poliestere) si può rimuovere completamente grazie alle cerniere incluse, cuscino interno double face, fondo antiscivolo, federa lavabile a 30°C | *Polyester, fyld (polyester) kan tages helt ud ved hjælp af lynlåsen, vendbar inderpude, skridsikker bund, betræk vaskbar ved 30°C*

braun | brown | marron | marrón | marrone | brun

S 61432  M 61433 

L 61434 

grau | grey | gris | gris | grigio | grå

S 61429  M 61430 

L 61431  XL 64383 

↕	■
S	60 x 50 cm
M	80 x 60 cm
L	100 x 70 cm
XL	120 x 80 cm



↕	▣
S	60 x 40 cm
M	80 x 60 cm
L	100 x 70 cm



Hundesofa EIBY

Dog sofa | Sofa pour chiens | Sofá para perros | Divano per cani | Hundesofa

Polyester, Füllung (Polyester) kann dank Reißverschlüssen komplett entnommen werden, schmutzabweisend ausgerüstet mit der EASY CLEAN-Technologie, Bezug bei 30°C waschbar | *Polyester, the filling (polyester) can be completely removed thanks to zip fastenings, dirt-resistant equipped with the EASY CLEAN technology, cover washable at 30°C* | Polyester, rembourrage (polyester) entièrement amovible grâce aux zips, anti-salissures, technologie EASY CLEAN, housse lavable à 30°C | *Poliéster, el relleno (poliéster) puede extraerse por completo gracias a las cremalleras, tratamiento resistente a las manchas y fácil de limpiar gracias a la tecnología EASY CLEAN, funda lavable a 30°C* | Poliestere, imbottitura (in poliester) completamente rimovibile grazie alle chiusure lampo, resistente allo sporco grazie alla tecnologia EASY CLEAN, federa lavabile a 30°C | *Polyester, fylld (polyester) kan toges helt ud ved hjælp af lynlåsen, smudsafvisende udstyret med EASY CLEAN-teknologi, betræk vaskbar ved 30°C*

gelb | yellow | jaune | amarillo | giallo | gul

S 68722 M 68723

L 68724

blau | blue | bleu | azul | blu | blå

S 68728 M 68729

L 68730

grau | grey | gris | gris | grigio | grå

S 68725 M 68726

L 68727

Easy Clean **Technology**





↗	📏
S	70 x 50 x 18 cm
M	80 x 60 x 18 cm
L	100 x 70 x 18 cm
XL	120 x 90 x 18 cm

Hunde-Steppbett LANCASTER

Quilted dog bed | Lit matelassée pour chien | Cama acolchada para perros | Piumone per cani | Quiltet hundeseng

Polyester, gesteppt, Füllung (Polyester) kann dank Reißverschlüssen komplett entnommen werden, rutschhemmende Unterseite, Bezug bei 30°C waschbar | *Polyester, quilted, Polyester filling can be completely removed using the zippers, non-slip bottom, cover washable at 30°C* | Polyester, matelassé, rembourrage (polyester) complètement amovible grâce à des fermetures éclair, partie inférieure antidérapante, housse lavable à 30°C | *Poliéster, acolchada, relleno (poliéster) puede extraerse por completo gracias a su cremallera, base antideslizante, funda lavable a 30°C* | Poliestere, trapuntato, l'imbottitura (poliestere) si può rimuovere completamente grazie alle cerniere incluse, fondo antiscivolo, federa lavabile a 30°C | *Polyester, quiltet, fyld (polyester) kan tages helt ud ved hjælp af lynlåsen, skridsikker bund, betræk vaskbar ved 30°C*

braun | brown | marron | marrón | marrone | brun

S 65062  M 65050 

L 65051  XL 65052 

grau | grey | gris | gris | grigio | grå

S 65060  M 65047 

L 65048  XL 65049 

Trotz der gesteppten Verarbeitung kann die Füllung entnommen werden.

Despite the quilted processing, the filling can be removed.





XXXL
175 x 145 cm



XXXL 175 x 145 cm

SUPER SIZE

Das Hundebett LANCASTER mit seinen unglaublichen 175 x 145 cm bietet Platz für Ihren Riesenhund, ein ganzes Rudel kleinerer Vierbeiner oder aber für Sie, wenn Sie eine ausgiebige Kuschelstunde mit Ihrer Fellnase verbringen wollen. Dieses Hundebett in Super-Size ist die perfekte Liegewiese in bewährter LANCASTER-Qualität.

The LANCASTER dog bed, with its unbelievable 175 x 145 cm dimensions, offers plenty of space for a giant dog, a whole pack of smaller dogs, or for you to enjoy an extended cuddle with your four-legged friend. This super-sized dog bed is the perfect place to relax and enjoy tried-and-tested LANCASTER quality.

Hundebett LANCASTER

Dog bed | Lit pour chiens | Cesta de perro | Letto per cani | Hundeseng

Polyester, Füllung (Polyester) kann dank Reißverschlüssen komplett entnommen werden, Bezug bei 30°C waschbar | *Polyester, Polyester filling can be completely removed using the zippers, cover washable at 30°C* | Polyester, rembourrage (polyester) complètement amovible grâce à des fermetures éclair, housse lavable à 30°C | *Poliéster, relleno (poliéster) puede extraerse por completo gracias a su cremallera, funda lavable a 30°C* | Poliestere, l'imbottitura (poliestere) si può rimuovere completamente grazie alle cerniere incluse, federa lavabile a 30°C | *Polyester, fylld (polyester) kan tages helt ud ved hjælp af lynlåsen, betæk vaskbar ved 30°C*

grau | grey | gris | gris | grigio | grå

XXXL 67650 







⇒	■
S	60 x 45 cm
M	80 x 60 cm
L	100 x 70 cm

Hundesofa GENT ANTIBAKTERIELL

Dog sofa | Sofa pour chiens | Sofá para perros | Divano per cani | Hundesofa

Polyester, Füllung (Polyester) kann dank Reißverschlüssen komplett entnommen werden, wendbares Innenkissen, wasser- und schmutzabweisend sowie antibakteriell ausgerüstet mit SILVERPLUS® und BIONIC FINISH® C6, Bezug bei 30°C waschbar | *Polyester, Polyester filling can be completely removed using the zippers, reversible inner cushion, water- and dirt-resistant, as well as anti-bacterially treated with SILVERPLUS® and BIONIC FINISH® C6, cover washable at 30°C* | Polyester, rembourrage (polyester) complètement amovible grâce à des fermetures éclair, coussin intérieur réversible, résistant à l'eau et à la saleté et traitement antibactérien avec SILVERPLUS® et BIONIC FINISH® C6, housse lavable à 30°C | *Poliéster, relleno (poliéster) puede extraerse por completo gracias a su cremallera, cojín interior reversible, repelente al agua y la suciedad así como antibacterial con SILVERPLUS® y BIONIC FINISH® C6, funda lavable a 30°C* | Poliestere, l'imbottitura (poliestere) si può rimuovere completamente grazie alle cerniere incluse, cuscino interno double face, idrofugo, antimacchia e antibatterico dotato di SILVERPLUS® e BIONIC FINISH® C6, federa lavabile a 30°C | *Polyester, fyld (polyester) kan tages helt ud ved hjælp af lynlåsen, vendbar inderpude, vand- og smudsafvisende samt antibakteriel udstyret med SILVERPLUS® og BIONIC FINISH® C6, betræk vaskbar ved 30°C*

braun | brown | marron | marrón | marrone | brun

S 61806 M 61807

L 62392

grau | grey | gris | gris | grigio | grå

S 61811 M 61812

L 62393

schwarz | black | noir | negro | nero | sort

S 61808 M 61809

L 61810

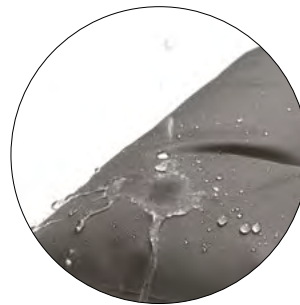



⇒	■
M	80 x 60 x 5 cm
L	100 x 70 x 5 cm

Hundebett GENT ANTIBAKTERIELL

Dog bed | Lit pour chiens | Cesta de perro | Letto per cani | Hundeseng

Polyester, Füllung (Polyester/ Schaumstoff) kann dank Reißverschlüssen komplett entnommen werden, wasser- und schmutzabweisend sowie antibakteriell ausgerüstet mit SILVERPLUS® und BIONIC FINISH® C6, Bezug bei 30°C waschbar | *Polyester, polyester/ foam filling can be completely removed using the zippers, water- and dirt-resistant, as well as anti-bacterially treated with SILVERPLUS® and BIONIC FINISH® C6, cover washable at 30°C* | Polyester, rembourrage (polyester/ mousse) complètement amovible grâce à des fermetures éclair, résistant à l'eau et à la saleté et traitement antibactérien avec SILVERPLUS® et BIONIC FINISH® C6, housse lavable à 30°C | *Poliéster, relleno (poliéster/ espuma) puede extraerse por completo gracias a su cremallera, repelente al agua y la suciedad así como antibacterial con SILVERPLUS® y BIONIC FINISH® C6, funda lavable a 30°C* | Poliestere, l'imbottitura (poliestere/ schiuma) si può rimuovere completamente grazie alle cerniere incluse, idrofugo, antimacchia e antibatterico dotato di SILVERPLUS® e BIONIC FINISH® C6, federa lavabile a 30°C | *Polyester, fjld (polyester/ skum) kan tages helt ud ved hjælp af lynlåsen, vand- og smudsafvisende samt antibakteriel udstyret med SILVERPLUS® og BIONIC FINISH® C6, betræk vaskbar ved 30°C*

braun | brown | marron | marrón | marrone | brun

M 61800 L 61801

grau | grey | gris | gris | grigio | grå

M 61802 L 61803

schwarz | black | noir | negro | nero | sort

M 61798 L 61799



geruchsneutral
odorless



wasser- und schmutzabweisend
water- and dirt-repellent



antibakteriell
antibacterial

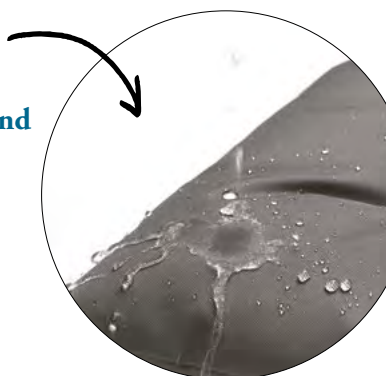

Mit den textilen Ausrüstungen SILVERPLUS® und BIONIC FINISH® C6 setzt HUNTER höchste Standards im Bereich funktionalen Hundezubehörs. Erfolgreich werden die ressourcenschonenden Technologien im Doppelpack genau da eingesetzt, wo Frische und Hygiene eine besonders große Rolle spielen. SILVERPLUS® verhindert die Vermehrung geruchsverursachender Bakterien, daher reichen schon Waschttemperaturen von 30-40 °C für einen wirkungsvollen Bakterienchutz aus. Wasser, ölige Flüssigkeiten und Schmutz perlen dank der BIONIC FINISH® C6 -Veredelung zuverlässig ab und erleichtern in hohem Maße die Pflege der Produkte.

With the SILVERPLUS® and BIONIC FINISH® C6 textile finishes, HUNTER is setting the highest standards in the functional dog accessory sector. The resource-saving technology in this double pack is successfully applied precisely where freshness and hygiene play a particularly significant role. SILVERPLUS® prevents odour-creating bacteria from multiplying, so even wash temperatures of 30-40 °C are enough to ensure effective bacteria protection. Water, oily liquids and dirt simply drip off thanks to the BIONIC FINISH® C6 finishing, facilitating care of the products to a great extent.



Hundekissen INARI

Dog cushion | Coussin pour chiens | Cojín para perro | Cuscino per cani | Hundepude

Polypropylen, Füllung (Polyester) kann dank Reißverschluss komplett entnommen werden, rutschhemmende Unterseite, Bezug bei 30 °C waschbar | *Polypropylene, filling (polyester) can be completely removed thanks to zip fastener, non-slip underside, cover washable at 30 °C* | Polypropylène, le rembourrage (polyester) peut être entièrement retiré grâce à une fermeture éclair, dessous antidérapant, housse lavable à 30 °C | *Polipropileno, el relleno (poliéster) se puede retirar completamente gracias al cierre de cremallera, parte inferior antideslizante, cubierta lavable a 30 °C* | Polipropilene, l'imbottitura (poliester) può essere completamente rimossa grazie alla chiusura lampo, lato inferiore antiscivolo, rivestimento lavabile a 30 °C | *Polypropylen, fylDET (polyester) kan fjernes helt takket vere lynlåsen, skridsikker underside, betræk kan vaskes ved 30 °C*

beige | tan | beige | beige | beige | beige

M 69591  L 69592 

XL 69593 

lindgrün | linden green | vert pâle | verde suave | verdino chiaro | lindengrøn

M 69594  L 69595 

XL 69596 

⇒	■
M	75 x 50 cm
L	100 x 70 cm
XL	120 x 75 cm





↗	▣
M	75 x 50 cm
L	100 x 70 cm
XL	120 x 75 cm

Hundekissen RIBE

Dog cushion | Coussin pour chiens | Cojín para perro | Cuscino per cani | Hundepude

Polyester, Füllung (Polyester) kann dank Reißverschlüssen komplett entnommen werden, wasserabweisend und strapazierfähig, Nutzung im Außenbereich möglich, Bezug bei 30 °C waschbar | *Polyester, filling (polyester) can be completely removed thanks to zips, water-repellent and hard-wearing, outdoor use possible, cover washable at 30 °C* | Polyester, le remplissage (polyester) peut être entièrement retiré grâce à des fermetures éclair, hydrofuge et résistant, utilisation possible en extérieur, housse lavable à 30 °C | *Poliéster, el relleno (poliéster) se puede retirar completamente gracias a las cremalleras, repelente al agua y resistente, se puede utilizar en el exterior, cubierta lavable a 30 °C* | Poliestere, imbottitura (poliestere) completamente rimovibile grazie alle cerniere, idrorepellente e resistente, utilizzabile all'aperto, copertura lavabile a 30 °C | *Polyester, fyld (polyester) kan fjernes helt takket være lynlåse, vandafvisende og slidstærkt, kan bruges udendørs, kan vaskes ved 30 °C*

dunkelgrün | dark green | vert foncé | verde oscuro | verde scuro | mørkegrøn

M	69621		L	69622	
XL	69623				
grau grey gris gris grigio grå					
M	69624		L	69625	
XL	69626				



Strapazierfähiges & wasserabweisendes Hundekissen

Dank des strapazierfähigen und wasserabweisenden Außenmaterials können raue oder harte Untergründe dem Outdoor-Kissen RIBE nichts anhaben. Es kann ganz nach Belieben mit nach draußen an die frische Luft genommen werden, bietet dem Vierbeiner hervorragenden Komfort und ein lauschiges Plätzchen zum Entspannen und Durchatmen.

Durable & water-repellent dog cushion. Thanks to the hard-wearing and water-repellent outer material, rough or hard surfaces cannot harm the outdoor cushion RIBE. It can be taken outside into the fresh air at will and offers your four-legged friend excellent comfort and a cosy place to relax and breathe deeply.





Ø
45 cm



Hunde- und Katzenschlafplatz LIVINGSTON

Dog and cat bed | Caverne pour chiens et chats | Cama para perros y gatos | Cuccetta per cani e gatti | Hunde- og kattesoveplads

Polyester, kann individuell in der Höhe variiert werden, sehr weicher Plüsch, bei 60°C waschbar | *Polyester, adjustable height, very soft plush, washable at 60°C* | Polyester, réglable individuellement en hauteur, peluche très douce, lavable à 60°C | *Poliéster, altura regulable, felpa muy suave, lavable a 60°C* | Poliestere, regolabile individualmente in altezza, felpato molto morbido, lavabile a 60°C | *Polyester, kan varieres individuelt i højden, meget blødt plys, vaskbar ved 60°C*

beige | tan | beige | beige | beige | beige

67427 

braun | brown | marron | marrón | marrone | brun

67426 

anthrazit | anthracite | anthracite | anthracita | anthracite | antracit

67428 



Kann individuell in der Höhe variiert werden
Adjustable height







≡	📏
S	60 x 45 cm
M	80 x 60 cm
L	100 x 75 cm

Hundesofa LIVINGSTON

Dog sofa | Sofa pour chiens | Sofá para perros | Divano per cani | Hundesofa



Polyester, Füllung (Polyester) kann dank Reißverschlüssen komplett entnommen werden, wendbares Innenkissen, Bezug bei 30°C waschbar | *Polyester, Polyester filling can be completely removed using the zippers, reversible inner cushion, cover washable at 30°C* | Polyester, rembourrage (polyester) complètement amovible grâce à des fermetures éclair, coussin intérieur réversible, housse lavable à 30°C | *Polyester, relleño (poliéster) puede extraerse por completo gracias a su cremallera, cojín interior reversible, funda lavable a 30°C* | Polyester, l'imbottitura (poliestere) si può rimuovere completamente grazie alle cerniere incluse, cuscino interno double face, federa lavabile a 30°C | *Polyester, fjild (polyester) kan tages helt ud ved hjælp af lynlåsen, vendbar inderpude, betræk vaskbar ved 30°C*

beige | tan | beige | beige | beige | beige

S 60856  M 60857 

L 60858 

braun | brown | marron | marrón | marrone | brun

S 60859  M 60860 

L 60861 

anthrazit | anthracite | anthracite | anthracita | anthracite | antracit

S 60862  M 60863 

L 60864 





↗	■
M	80 x 60 cm
L	100 x 80 cm

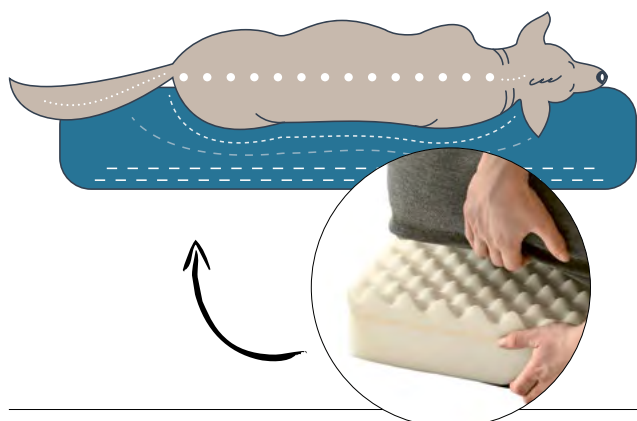

Alle Hunde verdienen einen gemütlichen, warmen Liegeplatz. Das gilt noch mehr für ältere oder kranke Tiere, auf die wir besondere Rücksicht nehmen müssen. Das orthopädische Hundesofa LIVINGSTON bietet auch Hunden mit Gelenk- und Rückenproblemen den gewünschten Komfort. Auf der Vorderseite hat das orthopädische Hundesofa LIVINGSTON keinen Rand, so dass das »Einsteigen« besonders einfach ist. Die Füllung aus Memoryschaum macht das Liegen extra schonend und die Decke mit kuscheligem Plüschbesatz und Reißverschluss tasche nimmt saugfähige Einlagen auf.

All dogs have a right to a warm and homely place to rest. This is especially true for older pets or ill pets, who require even more care. The LIVINGSTON orthopaedic dog sofa also offers dogs with joint or back problems the comfort they need. The LIVINGSTON orthopaedic dog sofa has no border to the front so that your dog can easily get in. The memory foam filling makes lying down extra gentle for your dog, and the blanket with a cosy plush trim and zip pocket can store absorbent incontinence pads.

Orthopädisches Hundesofa LIVINGSTON

Orthopedic dog sofa | Canapé orthopédique pour chien | Cama ortopédica para perros | Divano per cani ortopedico | Ortopédisk hundesofa

Polyester, Füllung (Polyester/Schaumstoff mit Memoryschaum-Oberfläche) kann dank Reißverschlüssen komplett entnommen werden, optimal für Hunde mit Gelenkproblemen, mit Reißverschluss tasche für saugfähige Einlagen, rutschhemmende Unterseite, Bezug bei 30°C waschbar | *Polyester, filling (Polyesterfoam with memory foam surface) can be completely removed using the zippers, optimal for dogs with joint problems, with zip pocket for absorbent pad, cover washable at 30°C, non-slip bottom* | Polyester, rembourrage (polyester/mousse avec surface en mousse à mémoire de forme) complètement amovible grâce à des fermetures éclair, optimal pour les chiens à problèmes articulaires, avec poche zippée pour alèse absorbante, partie inférieure antidérapante, housse lavable à 30°C | *Poliéster, relleno (Poliésterespuma con superficie de espuma viscoelástica) puede extraerse por completo gracias a su cremallera, adecuado para perros con problemas articulares, protección contra salpicaduras de agua, base antideslizante, funda lavable a 30°C* | Poliestere, l'imbottitura (Poliestere/schiuma con superficie in memory foam) si può rimuovere completamente grazie alle cerniere incluse, ottimale per cani con problemi alle articolazioni, con tasca con chiusura zip per inserti assorbenti, fondo antiscivolo, federa lavabile a 30°C | *Polyester, fjld (Polyester/skum med overflade af memory-skum) kan tages helt ud ved hjælp af lynlåsen, optimal til hunde med ledproblemer, med lynlåsomme til absorberende indlæg, skridsikker bund, betræk vaskbar ved 30°C*

anthrazit | anthracite | anthracite | anthracita | anthracite | antracit

M 65267 L 65268





⇒	■
M	80 x 60 x 8 cm
L	100 x 65 x 8 cm
XL	120 x 70 x 8 cm

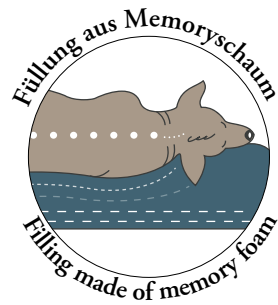

Orthopädische Hundematte TIRANO

Orthopaedic dog mat | Tapis orthopédique pour chien | Colchón ortopédico para perros | Tappetino ortopedico per cani | Ortopædisk hundemåtte

Polyester, Füllung (Polyurethan) kann dank Reißverschlüssen komplett entnommen werden, sehr weicher Plüsch, rutschhemmende Unterseite, optimal für ältere Hunde oder solche mit Erkrankungen des Bewegungsapparates, Bezug bei 30°C waschbar | *Polyester, polyurethane filling can be completely removed using the zippers, very soft plush, non-slip bottom, perfect for older dogs or those with illnesses of the musculoskeletal system, cover washable at 30°C* | Polyester, rembourrage (polyuréthane) complètement amovible grâce à des fermetures éclair, peluche très douce, partie inférieure antidérapante, idéal pour les chiens âgés ou atteints de maladies de l'appareil locomoteur, housse lavable à 30°C | *Poliéster, relleno (poliuretano) puede extraerse por completo gracias a su cremallera, felpa muy suave, base antideslizante, ideal para perros de edad avanzada o con enfermedades del aparato locomotor, funda lavable a 30°C* | Poliestere, l'imbottitura (poliuretano) si può rimuovere completamente grazie alle cerniere incluse, felpato molto morbido, fondo antiscivolo, ideale per cani anziani o con disturbi dell'apparato muscoloscheletrico, federa lavabile a 30°C | *Polyester, fyld (polyurethan) kan tages helt ud ved hjælp af lynlåsen, meget blødt plys, skridsikker bund, optimal til ældre hunde eller do med sygdomme i bevægelsesapparatet, betræk vaskbar ved 30°C*

grau | grey | gris | gris | grigio | grå

M 67692  L 67693 

XL 67694 

schwarz | black | noir | negro | nero | sort

M 67689  L 67690 

XL 67691 





MADE IN EUROPE

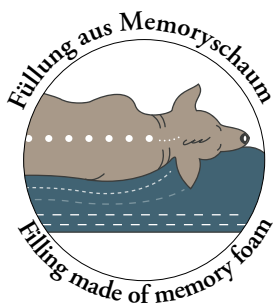

↗	📏
M	70 x 50 cm
L	90 x 70 cm
XL	120 x 80 cm

Orthopädisches Hundesofa MERIDA

Orthopaedic dog sofa | Sofa orthopédique pour chiens | Sofá ortopédico para perros | Divano ortopedico per cani | Ortopædisk hundesofa

Polyester, Füllung (Liegefläche: Memoryschaum-Flocken, erhöhter Rand: Polyester) kann dank Reißverschlüssen komplett entnommen werden, rutschhemmende Unterseite, optimal für ältere Hunde oder solche mit Erkrankungen des Bewegungsapparates, Bezug bei 30 °C waschbar | Polyester, filling (lying surface: memory foam flakes, raised edge: polyester) can be completely removed thanks to zips, non-slip underside, ideal for older dogs or those with musculoskeletal disorders, cover washable at 30 °C | Polyester, rembourrage (surface de couchage : flocons de mousse à mémoire de forme, bord surélevé : polyester) peut être entièrement retiré grâce à des fermetures éclair, dessous antidérapant, optimal pour les chiens âgés ou ceux souffrant de maladies de l'appareil locomoteur, housse lavable à 30 °C | Poliéster, relleno (superficie de reposo: copos de espuma viscoelástica, borde elevado: poliéster) totalmente desmontable gracias a las cremalleras, parte inferior antideslizante, ideal para perros mayores o con trastornos musculoesqueléticos, funda lavable a 30 °C | Poliester, imbottitura (superficie di appoggio: fiocchi di memory foam, bordo rialzato: poliester) completamente rimovibile grazie alle cerniere, lato inferiore antiscivolo, ideale per cani anziani o con disturbi muscoloscheletrici, rivestimento lavabile a 30 °C | Polyester, fyld (liggeflade: skumflager med hukommelseskum, forhøjet kant: polyester) kan fjernes helt takket være lynlåse, skridsikker underside, ideel til ældre hunde eller hunde med lidelser i bevægeapparatet, betræk kan vaskes ved 30 °C

taupe

M 69365 L 69366
 XL 69367

anthrazit | anthracite | anthracite | anthracita | anthracite | antracit

M 69361 L 69362
 XL 69363





Orthopädisches Hundesofa MERIDA 6-ECK

Orthopaedic dog sofa 6-corner | Sofa orthopédique pour chiens 6-angle | Sofá ortopédico para perros 6 esquinas | Divano ortopedico per cani 6 angoli | Ortopædisk hundesofa 6-hjørne

Polyester, Füllung (Liegefläche: Memoryschaum-Flocken, erhöhter Rand: Polyester) kann dank Reißverschlüssen komplett entnommen werden, wendbares Innenkissen, sechseckige Form, rutschhemmende Unterseite, optimal für ältere Hunde oder solche mit Erkrankungen des Bewegungsapparates, Bezug bei 30 °C waschbar | *Polyester, filling (lying surface: memory foam flakes, raised edge: polyester) can be completely removed thanks to zips, reversible inner cushion, hexagonal shape, non-slip underside, ideal for older dogs or those with musculoskeletal disorders, cover washable at 30 °C* | Polyester, rembourrage (surface de couchage : flocons de mousse à mémoire de forme, bord surélevé : polyester) peut être entièrement retiré grâce à des fermetures éclair, coussin intérieur réversible, forme hexagonale, dessous antidérapant, optimal pour les chiens âgés ou ceux souffrant de maladies de l'appareil locomoteur, housse lavable à 30 °C | *Poliéster, relleno (superficie de reposo: copos de espuma viscoelástica, borde elevado: poliéster) totalmente desmontable gracias a las cremalleras, cojín interior reversible, forma hexagonal, parte inferior antideslizante, ideal para perros mayores o con trastornos musculoesqueléticos, funda lavable a 30 °C* | Poliestere, imbottitura (superficie di appoggio: fiocchi di memory foam, bordo rialzato: poliestere) completamente rimovibile grazie alle cerniere, cuscino interno double face, forma esagonale, lato inferiore antiscivolo, ideale per cani anziani o con disturbi muscoloscheletrici, rivestimento lavabile a 30 °C | *Polyester, fylld (liggeflade: skumflager med hukommelseskum, forhøjet kant: polyester) kan fjernes helt takket være lynlåse, vendbar inderpude, sekskantet form, skridsikker underside, ideel til ældre hunde eller hunde med lidelser i bevægeapparatet, betræk kan vaskes ved 30 °C*

taupe

M 201860  L 201861 

XL 201862 

anthrazit | anthracite | anthracite | anthracita | anthracite | antracit

M 201863  L 201864 

XL 201865 

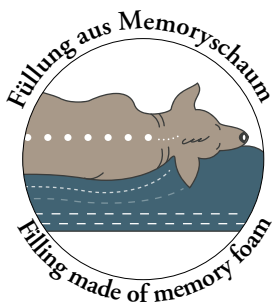

↕	Ø
M	70 cm
L	90 cm
XL	110 cm





MADE IN EUROPE

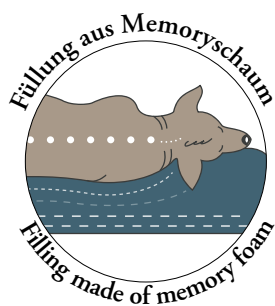

	⇒	■
M	75 x 50 x 15 cm	
L	100 x 70 x 15 cm	
XL	120 x 75 x 15 cm	

Orthopädisches Hundekissen MERIDA

Orthopaedic dog cushion | Coussin orthopédique pour chien | Cojín ortopédico para perros | Cuscino ortopedico per cani | Ortopædisk hundepude

Polyester, Füllung (Memoryschaum-Flocken) kann dank Reißverschlüssen komplett entnommen werden, rutschhemmende Unterseite, optimal für ältere Hunde oder solche mit Erkrankungen des Bewegungsapparates, Bezug bei 30°C waschbar | Polyester, memory foam flakes filling can be completely removed using the zippers, non-slip bottom, perfect for older dogs or those with illnesses of the musculoskeletal system, cover washable at 30°C | Polyester, rembourrage (mousse à mémoire de forme flocons) complètement amovible grâce à des fermetures éclair, partie inférieure antidérapante, idéal pour les chiens âgés ou atteints de maladies de l'appareil locomoteur, housse lavable à 30°C | Poliéster, relleno (espuma con efecto memoria copos) puede extraerse por completo gracias a su cremallera, base antideslizante, ideal para perros de edad avanzada o con enfermedades del aparato locomotor, funda lavable a 30°C | Poliestere, l'imbottitura schiuma memory fiocchi) si può rimuovere completamente grazie alle cerniere incluse, fondo antiscivolo, ideale per cani anziani o con patologie dell'apparato muscoloscheletrico, federa lavabile a 30°C | Polyester, fjild (Memory-skum totter) kan tages helt ud ved hjælp af lynlåsen, skridsikker bund, optimal til ældre hunde eller do. med sygdomme i bevægelsesapparatet, betræk vaskbar ved 30°C

mauve | mauve | mauve | malva | malva | mauve

M 69609 L 69610
XL 69611

olivgrün | olive green | vert olive | verde oliva | verde oliva | olivengrøn

M 69279 L 69280
XL 69281

taupe

M 67716 L 67717
XL 67718

anthrazit | anthracite | anthracite | anthracita | anthracite | antracit

M 67713 L 67714
XL 67715



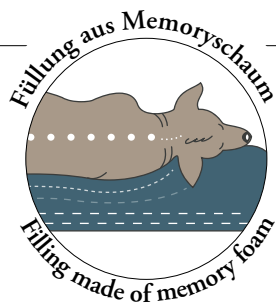

Größe	Maße
S	60 x 40 cm
M	80 x 60 cm
L	100 x 80 cm

Orthopädisches Hundesofa TROSA

Orthopaedic dog sofa | Sofa orthopédique pour chiens | Sofá ortopédico para perros | Divano ortopedico per cani | Ortopedisk hundesofa

Baumwolle/Polyester (vorwiegend recycelte Materialien), Füllung (Polyester/ Liegefläche Memoryschaum) kann dank Reißverschlüssen komplett entnommen werden, wendbares Innenkissen mit Teddyplüsch, optimal für ältere Hunde oder solche mit Erkrankungen des Bewegungsapparates, Bezug bei 30°C waschbar | Cotton/polyester (mainly recycled materials), filling (polyester/memory foam lying surface) can be completely removed thanks to zip fasteners, reversible inner cushion with teddy plush, ideal for older dogs or those with musculoskeletal disorders, cover washable at 30°C | Coton/polyester (principalement des matériaux recyclés), le rembourrage (polyester/mousse à mémoire de forme) peut être entièrement retiré grâce à des fermetures éclair, coussin intérieur réversible en peluche, idéal pour les chiens âgés ou souffrant de maladies de l'appareil locomoteur, housse lavable à 30°C | Algodón/poliéster (principalmente materiales reciclados), relleno (poliéster/espuma viscoelástica) totalmente extraíble gracias a los cierres de cremallera, cojín interior reversible con peluche, ideal para perros mayores o con trastornos musculoesqueléticos, funda lavable a 30°C | Cotone/ poliester (principalmente materiali riciclati), imbottitura (superficie di sdraio in poliester/memory foam) completamente estraibile grazie alle cerniere lampo, cuscino interno reversibile con peluche di orsetto, ideale per cani anziani o con disturbi muscolo-scheletrici, fodera lavabile a 30°C | Bomuld/polyester (hovedsageligt genbrugsmaterialer), fyld (polyester/memory foam-liggeflade) kan tages helt ud med lynlås, vendbar inderpude med bamseplys, ideel til ældre hunde eller hunde med lidelser i bevægeapparatet, betræk kan vaskes ved 30°C

beige | tan | beige | beige | beige | beige

S 204820  M 204822 

L 204824 

grau | grey | gris | gris | grigio | grå

S 204814  M 204816 

L 204818 





↗	Ø
S	50 cm
M	70 cm
L	90 cm

Hundekissen KUMARA

Dog cushion | Coussin pour chiens | Cojín para perro | Cuscino per cani | Hundepude

Polyester, Füllung kann dank Reißverschlüssen komplett entnommen werden, rutschhemmende Unterseite, Bezug bei 30°C waschbar | *Polyester, filling can be completely removed thanks to zips, non-slip underside, cover washable at 30°C* | Polyester, le rembourrage peut être entièrement retiré grâce à des fermetures éclair, dessous antidérapant, housse lavable à 30°C | *Poliéster, relleno totalmente extraíble gracias a las cremalleras, parte inferior antideslizante, funda lavable a 30°C* | Poliestere, imbottitura completamente estraibile grazie alle cerniere, fondo antiscivolo, rivestimento lavabile a 30°C | *Polyester, fyld kan fjernes helt takket være lynlåse, skridsikker underside, betræk kan vaskes ved 30°C*

khaki | kaki | kaki | caqui | cachi | kaki

S 204940  M 204942 

L 204944 

grau | grey | gris | gris | grigio | grå

S 204946  M 204948 

L 204950 

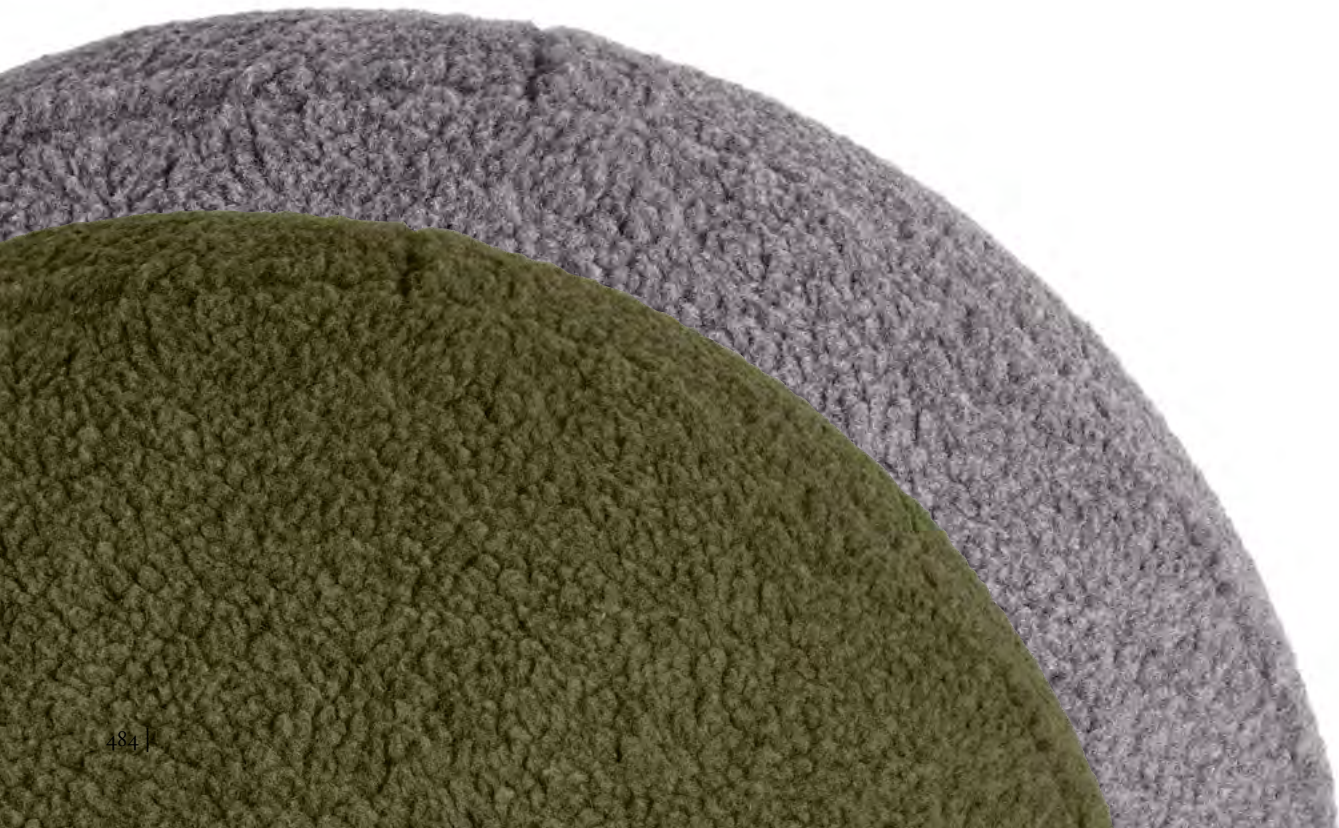



↔	■
S	60 x 40 cm
M	80 x 60 cm
L	100 x 70 cm

Hundesofa KUMARA

Dog sofa | Sofa pour chiens | Sofá para perros | Divano per cani | Hundesofa

Polyester, Füllung kann dank Reißverschlüssen komplett entnommen werden, wendbares Innenkissen, Bezug bei 30°C waschbar, rutschhemmende Unterseite | *Polyester, filling can be completely removed thanks to zips, reversible inner cushion, cover washable at 30°C, non-slip underside* | Polyester, le remplissage peut être entièrement retiré grâce à des fermetures éclair, coussin intérieur réversible, housse lavable à 30°C, dessous antidérapant | *Poliéster, relleno totalmente extraíble gracias a las cremalleras, cojín interior reversible, funda lavable a 30°C, parte inferior antideslizante* | Poliestere, imbottitura completamente estraibile grazie alle cerniere, cuscino interno reversibile, rivestimento lavabile a 30°C, fondo antiscivolo | *Polyester, fyldet kan tages helt ud med lynlås, vendbar inderpude, betrækket kan vaskes ved 30°C, skridsikker underside*

khaki | kaki | kaki | caqui | cachi | kaki

S 204928 M 204930

L 204932

grau | grey | gris | gris | grigio | grå

S 204934 M 204936

L 204938



Mit vier gleich hohen Seiten
With four sides of equal height

NEW SHAPE



Hundekissen NORA

Dog cushion | Coussin pour chiens | Cojín para perro | Cuscino per cani | Hundepude

Polyester, asymmetrische Form, Füllung kann dank Reißverschlüssen komplett entnommen werden, schmutzabweisend ausgerüstet, Bezug bei 30°C waschbar | *Polyester, asymmetrical shape, filling can be completely removed thanks to zips, dirt-repellent finish, cover washable at 30°C* | Polyester, forme asymétrique, le remplissage peut être entièrement retiré grâce à des fermetures éclair, traitement anti-salissures, housse lavable à 30°C | *Poliéster, forma asimétrica, el relleno se puede quitar completamente gracias a las cremalleras, acabado repelente a la suciedad, funda lavable a 30°C* | Poliestere, forma asimmetrica, l'imbottitura può essere completamente rimossa grazie alle cerniere, finitura repellente allo sporco, rivestimento lavabile a 30°C | *Polyester, asymmetrisk form, fjld kan fjernes helt takket være lynlåse, smudsafvisende finish, betræk kan vaskes ved 30°C*

braun | brown | marron | marrón | marrone | brun

S 200342  M 200344 

L 200346 

grau | grey | gris | gris | grigio | grå

S 200336  M 200338 

L 200340 

↑	Ø
S	70 cm
M	90 cm
L	110 cm



Schmutzabweisend ausgerüstet
Dirt-repellent finish



Abstract design

ABSTRAKTES
DESIGN

6-CORNERED



Hundesofa NORA 6-ECK

Dog sofa 6-corner | Sofa pour chiens 6-angle | Sofá para perros 6 esquinas | Divano per cani 6 angoli | Hundesofa 6-hjørne

Polyester, sechseckige Form, rutschhemmende Unterseite, wendbares Innenkissen, Füllung kann dank Reißverschlüssen komplett entnommen werden, schmutzabweisend ausgerüstet, Bezug bei 30°C waschbar | *Polyester, hexagonal shape, non-slip underside, reversible inner cushion, filling can be completely removed thanks to zips, dirt-repellent finish, cover washable at 30°C* | Polyester, forme hexagonale, dessous antidérapant, coussin intérieur réversible, le remplissage peut être entièrement retiré grâce à des fermetures éclair, traité anti-salissures, housse lavable à 30°C | *Poliéster, forma hexagonal, parte inferior antideslizante, cojín interior reversible, parte inferior antideslizante, el relleno se puede quitar completamente gracias a las cremalleras, acabado repelente a la suciedad, funda lavable a 30°C* | Poliester, forma esagonale, fondo antiscivolo, cuscino interno reversibile, fondo antiscivolo, imbottitura completamente estraibile grazie alle cerniere, finitura repellente allo sporco, rivestimento lavabile a 30°C | *Polyester, sekskantet form, skridsikker underside, vendbar inderpude, skridsikker underside, fyllet kan tages helt ud med lynlåse, smudsafvisende finish, betræk kan vaskes ved 30°C*

braun | brown | marron | marrón | marrone | brun

S 200354  M 200356 

L 200358 

grau | grey | gris | gris | grigio | grå

S 200348  M 200350 

L 200352 

Schmutzabweisend ausgerüstet
Dirt-repellent finish

↔	∅
S	60 cm
M	80 cm
L	100 cm





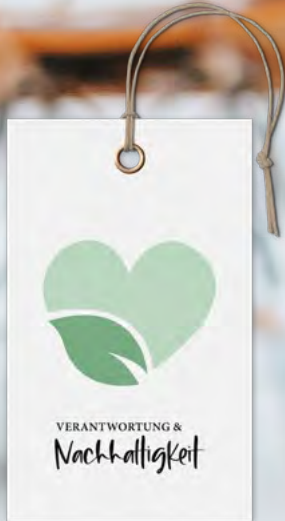

BELLUNO
Nachhaltige Schlafplätze
Sustainable beds





Size	Dimensions
S	60 x 40 cm
M	80 x 60 cm
L	100 x 80 cm

Recycling Hundesofa BELLUNO

Dog sofa | Sofa pour chiens | Sofá para perros | Divano per cani | Hundesofa

Baumwolle/Polyester, Füllung Polyester (vorwiegend recycelte Materialien) kann dank Reißverschluss komplett entnommen werden, wendbares Innenkissen, rutschhemmende Unterseite, Bezug bei 30°C waschbar | *Cotton/polyester, polyester filling (mainly recycled materials) can be completely removed thanks to zip, reversible inner cushion, non-slip underside, cover washable at 30°C* | Coton/polyester, remplissage polyester (principalement des matériaux recyclés) peut être entièrement retiré grâce à la fermeture éclair, coussin intérieur réversible, dessous antidérapant, housse lavable à 30°C | *Algodón/poliéster, relleno de poliéster (principalmente materiales reciclados) totalmente extraíble gracias a la cremallera, cojín interior reversible, parte inferior antideslizante, funda lavable a 30°C* | Cotone/poliestere, imbottitura in poliestere (principalmente materiali riciclati) completamente estraibile grazie alla cerniera, cuscino interno reversibile, lato inferiore antiscivolo, rivestimento lavabile a 30°C | *Bomuld/polyester, polyesterfyld (hovedsageligt genbrugs-materialer) kan tages helt ud med lynlås, vendbar inderpude, skridsikker underside, betæk kan vaskes ved 30°C*

creme | cream | crème | crema | crema | creme

S 200360 M 200362

L 200364

mint | mint | menthe | menta | menta | mynte

S 200372 M 200374

L 200376

braun | brown | marron | marrón | marrone | brun

S 200366 M 200368

L 200370





⇒	■
M	80 x 60 cm
L	100 x 70 cm
XL	120 x 80 cm



Recycling Hundekissen BELLUNO

Dog cushion | Coussin pour chiens | Cojín para perro | Cuscino per cani | Hundepude

Baumwolle/Polyester, Füllung Polyester (vorwiegend recycelte Materialien) kann dank Reißverschluss komplett entnommen werden, rutschhemmende Unterseite, Bezug bei 30°C waschbar | *Cotton/polyester, polyester filling (mainly recycled materials) can be completely removed thanks to zip, non-slip underside, cover washable at 30°C* | Coton/polyester, remplissage polyester (principalement des matériaux recyclés) peut être entièrement retiré grâce à la fermeture éclair, dessous antidérapant, housse lavable à 30°C | *Algodón/poliéster, relleno de poliéster (principalmente materiales reciclados) totalmente extraíble gracias a la cremallera, parte inferior antideslizante, funda lavable a 30°C* | Cotone/poliestere, imbottitura in poliester (principalmente materiali riciclati) completamente estraibile grazie alla cerniera, lato inferiore antiscivolo, rivestimento lavabile a 30°C | *Bomuld/polyester, polyesterfyld (hovedsageligt genbrugsmaterialer) kan tages helt ud med lynlås, skridsikker underside, betræk kan vaskes ved 30°C*

creme | cream | crème | crema | crema | creme

M 200378 L 200380

XL 200382

mint | mint | menthe | menta | menta | mynte

M 200390 L 200392

XL 200394

braun | brown | marron | marrón | marrone | brun

M 200384 L 200386

XL 200388





↗	■
S	60 x 45 cm
M	80 x 60 cm



■
120 x 80 cm

Hundesofa ASTANA

Dog sofa | Sofa pour chiens | Sofá para perros | Divano per cani | Hundesofa

Baumwolle/Polyester, Füllung (Polyester) kann dank Reißverschlüssen komplett entnommen werden, sehr weicher Plüsch, wendbares Innenkissen, Bezug bei 30°C waschbar | *Cotton/Polyester, polyester filling can be completely removed using the zippers, very soft plush, reversible inner cushion, cover washable at 30°C* | Coton/Polyester, rembourrage (polyester) complètement amovible grâce à des fermetures éclair, peluche très douce, coussin intérieur réversible, housse lavable à 30°C | *Algodón/Poliéster, relleno (poliéster) puede extraerse por completo gracias a su cremallera, felpa muy suave, cojín interior reversible, funda lavable a 30°C* | Cotone/Poliestere, l'imbottitura (poliestere) si può rimuovere completamente grazie alle cerniere incluse, felpato molto morbido, cuscino interno double face, federa lavabile a 30°C | *Bomuld/Polyester, fyld (polyester) kan tages helt ud ved hjælp af lynlåsen, meget blødt plys, vendbar inderpude, betræk vaskbar ved 30°C*

beige | tan | beige | beige | beige | beige

S 61925  M 61926 

rot | red | rouge | rojo | rosso | rød

S 61923  M 61924 

grau | grey | gris | gris | grigio | grå

S 63956  M 63957 

Hundedecke ASTANA

Dog blanket | Couverture pour chiens | Manta de perro | Coperta per cani | Hundeteppe

Oberseite aus Polyester/Baumwolle, Unterseite aus Polyester (sehr weicher Plüsch), bei 30°C waschbar | *upper surface made from polyester/cotton, bottom made from polyester (very soft plush), washable at 30°C* | dessus en polyester/coton, dessous en polyester (peluche très douce), lavable à 30°C | *parte superior de poliéster/algodón, parte inferior de poliéster (felpa muy suave), lavable a 30°* | parte superiore in poliestere/cotone, parte inferiore in poliestere (felpato molto morbido), lavabile a 30°C | *overside af polyester/bomuld, underside af polyester (meget blødt plys), vaskbar ved 30°C*

beige | tan | beige | beige | beige | beige

61928 

rot | red | rouge | rojo | rosso | rød

61927 





Hundesofa UNIVERSITY

Dog sofa | Sofa pour chiens | Sofá para perros | Divano per cani | Hundesofa

Polyester, Füllung (Polyester) kann dank Reißverschlüssen komplett entnommen werden, wendbares Innenkissen, sehr weicher Plüsch, Bezug bei 30°C waschbar | *Polyester, polyester filling can be completely removed using the zippers, reversible inner cushion, very soft plush, cover washable at 30°C* | Polyester, rembourrage (polyester) complètement amovible grâce à des fermetures éclair, coussin intérieur réversible, peluche très douce, housse lavable à 30°C | *Poliéster, relleno (poliéster) puede extraerse por completo gracias a su cremallera, cojín interior reversible, felpa muy suave, funda lavable a 30°C* | Poliestere, l'imbottitura (poliestere) si può rimuovere completamente grazie alle cerniere incluse, cuscino interno double face, felpato molto morbido, federa lavabile a 30°C | *Polyester, fyld (polyester) kan tages helt ud ved hjælp af lynlåsen, vendbar inderpude, meget blødt plys, betæk vaskbar ved 30°C*

beige | tan | beige | beige | beige | beige

S 61388  M 61389 

L 61390 

grau | grey | gris | gris | grigio | grå

S 61381  M 61382 

L 61383 



↗	▣
S	60 x 40 cm
M	80 x 60 cm
L	100 x 80 cm



Das stylecats® Design

Die stylecats® Kollektion verfolgt seit dem Jahr 2011 einen völlig neuen Designansatz. Es geht nicht nur um eine Symbiose aus Gestaltung und Funktion, sondern es stehen die Bedürfnisse der Katzen und Katzenbesitzer im Vordergrund.

stylecats®-Produkte folgen dem Credo alles Überflüssige wegzunehmen, um die reine Form zu erhalten - im Bereich Katzenszubehör ist das ein ganz neuer Ansatz.

Die stylecats® Kratzbäume fügen sich in nahezu allen Wohnumfeldern selbstverständlich ein. Design ist unserer Meinung nach kein Selbstzweck. Das Design unserer Katzenmöbel ist kompakt und reduziert.

Since 2011, the stylecats® collection has been pursuing a completely new design approach. It is not only about a symbiosis of design and function, but also the needs of cats and cat owners take centre stage.

stylecats® products follow the credo of removing everything superfluous in order to preserve the pure form - this is a completely new approach in the field of cat accessories.

The stylecats® scratching posts fit naturally into almost any living environment. In our opinion, design is not an end in itself. The design of our cat furniture is compact and reduced.



Wertigkeit

Das bedeutet auch eine langlebige Robustheit gekoppelt mit innovativen Austauschmöglichkeiten. Denn stylecats®-Kratzbäume sind nicht nur einfache Gebrauchsartikel, sondern echte Wertgegenstände mit hoher Attraktivität. Hochwertige, Materialien finden Verwendung in allen stylecats®-Kratzbäumen.

Gegenüber »normalen« Möbeln ist der Kratzbaum enormen Strapazen ausgesetzt. Durch das Springen der Katze wirken permanent dynamische Kräfte auf den Kratzbaum. Darüber hinaus müssen die eingesetzten Textilien strapazierfähig sein, damit sich Miezi die Krallen schärfen kann oder auch die Liegeflächen unbewusst ausgefahrene Krallen überstehen.

Value

This also means long-lasting robustness coupled with innovative replacement options. Because stylecats® scratching posts are not just simple articles of daily use, but genuine items of value with a high level of attractiveness. High-quality materials are used in all stylecats® scratching posts.

Compared to »normal« furniture, the scratching post is exposed to enormous strain. The jumping of the cat exerts permanent dynamic forces on the scratching post. In addition, the textiles used must be hard-wearing so that Miezi can sharpen her claws or the lying surfaces can withstand unconsciously extended claws.

Das Original

Als stylecats® 2011 mit den ersten Entwürfen begann, fand man gänzlich im europäischen Heimtiermarkt, kein modernes, geradliniges oder gar integratives, möbelähnliches Katzenszubehör - Verschleißteile waren auch nicht austauschbar. stylecats® hat über 50 Schutzrechte (eingetragenes Design, Markenschutz, Patente) beim Europäischen Patentamt registriert und geltend gemacht.

The original

When stylecats® started with the first designs in 2011, there were no modern, straightforward or even integrative, furniture-like cat accessories on the European pet market - wear parts were also not interchangeable. stylecats® has registered and asserted over 50 property rights (registered design, trademark protection, patents) at the European Patent Office.





Kratzbaum 2 Liegeflächen OWEN

Scratching post 2 lying surfaces | Arbre à chat 2 surfaces de repos | Rascador 2 superficies de descanso | Graffiatoio 2 superfici di appoggio | Kradsetræ 2 liggeflader

MDF/Sisal, freistehender Kratzbaum, 2 Liegeflächen, puristsiches Design | *Medium density fibreboard/sisal, free-standing scratching post, 2 lying surfaces, purist design* | Panneau de fibres de bois de densité moyenne/sisal, arbre à chat indépendant, 2 surfaces de repos, design puriste | *Tablero de fibra de densidad media/sisal, rascador independiente, 2 superficies para tumbarse, diseño purista* | Pannello di fibra a media densità/sisalvia, tiragraffi indipendente, 2 superfici di appoggio, design purista | *Medium density fiberboard/sisal, fritstående kradsetræ, 2 liggeflader, puristisk design*

mit Kratzfläche | with scratching surface | avec surface à gratter | con superficie rascable | con superficie graffiante | med ridsende overflade

109 cm 271168 

 90 x 55 x 109 cm





Kratzbaum 3 Liegeflächen OWEN

Scratching post 3 lying surfaces | Arbre à chat 3 surfaces de repos | Rascador 3 superficies de descanso | Graffiatoio 3 superfici di appoggio | Kradsetræ 3 liggeflader

MDF/Sisal, freistehender Kratzbaum, 3 Liegeflächen, puristsiches Design | *Medium density fibreboard/sisal, free-standing scratching post, 3 lying surfaces, purist design* | Panneau de fibres de bois de densité moyenne/sisal, arbre à chat indépendant, 3 surfaces de repos, design puriste | *Tablero de fibra de densidad media/sisal, rascador independiente, 3 superficies para tumbarse, diseño purista* | Pannello di fibra a media densità/sisalvia, tiragraffi indipendente, 3 superfici di appoggio, design purista | *Medium density fiberboard/sisal, fritstående kradsetræ, 3 liggeflader, puristisk design*

mit Kratzfläche | with scratching surface | avec surface à gratter | con superficie rascable | con superficie graffiante | med ridsende overflade

145 cm 271170 

 90 x 55 x 145 cm

Kratzbaum OWEN

Scratching post

Der Kratzbaum OWEN von stylecats® überzeugt durch sein geradliniges, modernes Design und seine besondere Wertigkeit.

The OWEN scratching post from stylecats® impresses with its straightforward, modern design and special value.

Kombinierbar mit den Katzenbetten:
Can be combined with cat beds:

DREAMIE, RIMINI & GROOVIE

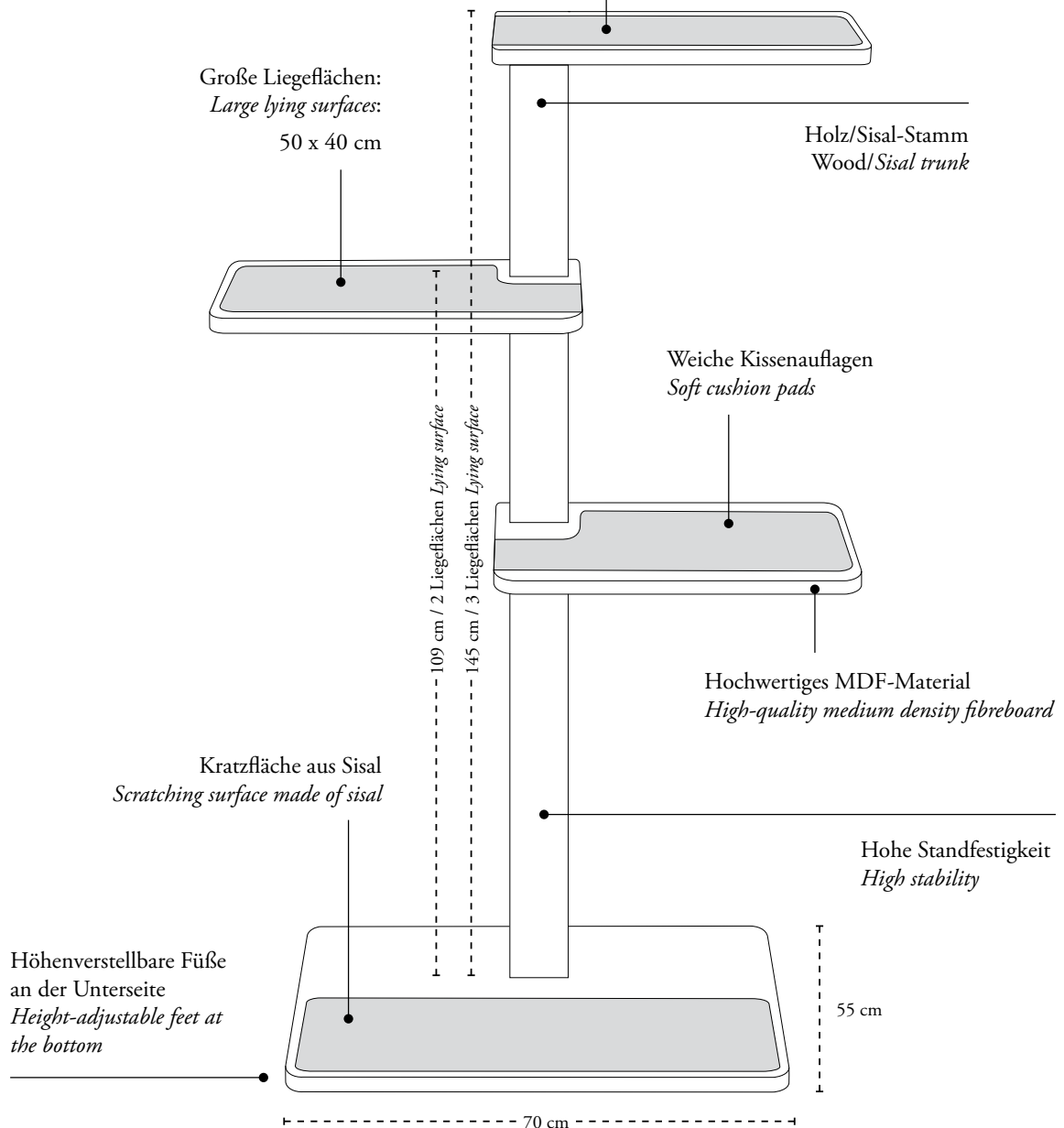

Sein quadratischer Stamm (8 x 8 cm) aus neuseeländischer Kiefer/Pinie ist standardmäßig komplett mit strapazierfähigem 100 % Sisal bezogen. Große Liegeflächen, hochwertige Materialien und seine coole Optik machen OWEN zu einem echten Spitzenprodukt. Den Kratzbaum gibt es mit 2 oder 3 Liegeflächen, weichen Kissenauflagen und mit einer Kratzfläche aus Sisal auf der Bodenplatte.

Its square trunk (8 x 8 cm) made of New Zealand pine is completely covered with hard-wearing 100 % sisal as standard. Large lying surfaces, high-quality materials and its cool look make OWEN a real top product. The scratching post is available with 2 or 3 lying surfaces, soft cushion pads and a sisal scratching surface on the base plate.



Kratzturm TUMBA

Scratch tower | Tour à chat | Torre de rascado | Torre di graffiatura | Kradsetårn

MDF/Sisal, freistehender Kratzturm, 3/4 Liegeflächen, puristsches Design | *Medium density fibreboard/sisal, free-standing scratching tower, 3/4 lying surfaces, purist design* | Panneau de fibres de bois de densité moyenne/sisal, tour à gratter indépendante, 3/4 surfaces de repos, design puriste | *Tablero de fibra de densidad media/sisal, torre rascadora independiente, 3/4 superficies tumbadas, diseño purista* | Pannello di fibra a media densità/sisalvia, torre tiragraffi autoportante, 3/4 superfici distese, design purista | *Medium density fiberboard/sisal, fristående kradsetårn, 3/4 liggeflader, puristisk design*

1: 3 Liegeflächen | 3 lying surfaces | 3 surfaces de couchage | 3 superficies tumbadas | 3 superfici distese | 3 liggende overflader

M 271171 

2: 4 Liegeflächen | 4 lying surfaces | 4 surfaces de couchage | 4 superficies tumbadas | 4 superfici distese | 4 liggende overflader

L 271172 

Befestigungs-/Sicherungsmöglichkeit
an der Wand
*Fastening/securing option
on the wall*

Robust & langlebig, Einsatz
von hochwertigen Materialien
*Robust & durable, use of
high-quality materials*

Austauschbare Textilteile
Replaceable textile parts

Große Kratzfläche aus Sisal
Large scratching surface made of sisal

↗	■
M	40 x 40 x 81 cm
L	40 x 40 x 120 cm



↑ ■
S 40 x 40 cm

Katzenbett DREAMIE

Cat bed | Lit pour chat | Cama para gatos | Letto per gatti | Katteseng

Polyester, Füllung (Polyester) kann dank Reißverschlüssen komplett entnommen werden, wasserabweisend, Innenkissen herausnehmbar, Bezug bei 30°C waschbar | *Polyester, Polyester filling can be completely removed using the zippers, water-repellent, removable inner cushion, non-slip bottom, cover washable at 30°C* | Polyester, rembourrage (polyester) complètement amovible grâce à des fermetures éclair, hydrofuge, coussin intérieur amovible, partie inférieure antidérapante, housse lavable à 30°C | *Polyester, relleno (poliéster) puede extraerse por completo gracias a su cremallera, repelente al agua, cojín interior extraíble, base antideslizante, funda lavable a 30°C* | Polyester, l'imbottitura (poliestere) si può rimuovere completamente grazie alle cerniere incluse, idrorepellente, cuscino interno rimovibile, fondo antiscivolo, federa lavabile a 30°C | *Polyester, fylld (polyester) kan toges helt ud ved hjælp af lynlåsen, vandafvisende, udtagelig inderpude, betræk vaskbar ved 30°C*

beige | tan | beige | beige | beige | beige

S 276048

hellgrau | light grey | gris clair | gris claro | grigio chiaro | lysegrå

S 276049



↑ ■
S 40 x 40 cm

Katzenbett RIMINI

Cat bed | Lit pour chat | Cama para gatos | Letto per gatti | Katteseng

Polyester, Füllung (Polyester) kann dank Reißverschlüssen komplett entnommen werden, Innenkissen herausnehmbar, Bezug bei 30°C waschbar | *Polyester, Polyester filling can be completely removed using the zippers, removable inner cushion, non-slip bottom, cover washable at 30°C* | Polyester, rembourrage (polyester) complètement amovible grâce à des fermetures éclair, coussin intérieur amovible, partie inférieure antidérapante, housse lavable à 30°C | *Polyester, relleno (poliéster) puede extraerse por completo gracias a su cremallera, cojín interior extraíble, base antideslizante, funda lavable a 30°C* | Polyester, l'imbottitura (poliestere) si può rimuovere completamente grazie alle cerniere incluse, cuscino interno rimovibile, fondo antiscivolo, federa lavabile a 30°C | *Polyester, fylld (polyester) kan toges helt ud ved hjælp af lynlåsen, udtagelig inderpude, betræk vaskbar ved 30°C*

beige | tan | beige | beige | beige | beige

S 276056

hellgrau | light grey | gris clair | gris claro | grigio chiaro | lysegrå

S 276052









≠ Ø
S 50 cm

Katzenbett CUSIO

Cat bed | Lit pour chat | Cama para gatos | Letto per gatti | Katteseng

Polyester, Füllung (Polyester) kann dank Reißverschlüssen komplett entnommen werden, Innenkissen herausnehmbar, Bezug bei 30°C waschbar | Polyester, Polyester filling can be completely removed using the zippers, removable inner cushion, non-slip bottom, cover washable at 30°C | Polyester, rembourrage (polyester) complètement amovible grâce à des fermetures éclair, coussin intérieur amovible, partie inférieure antidérapante, housse lavable à 30°C | Polyester, relleno (poliéster) puede extraerse por completo gracias a su cremallera, cojín interior extraíble, base antideslizante, funda lavable a 30°C | Polyester, l'imbottitura (poliestere) si può rimuovere completamente grazie alle cerniere incluse, cuscino interno rimovibile, fondo antiscivolo, federa lavabile a 30°C | Polyester, fyld (polyester) kan tages helt ud ved hjælp af lynlåsen, udtagelig inderpude, betræk vaskbar ved 30°C

hellgrau | light grey | gris clair | gris claro | grigio chiaro | lysegrå

S 276062



≠ Ø
S 50 cm

Katzenbett BARONA

Cat bed | Lit pour chat | Cama para gatos | Letto per gatti | Katteseng

Polyester, Füllung (Polyester) kann dank Reißverschlüssen komplett entnommen werden, wasserabweisend, Innenkissen herausnehmbar, Bezug bei 30°C waschbar | Polyester, rembourrage (polyester) complètement amovible grâce à des fermetures éclair, hydrofuge, coussin intérieur amovible, partie inférieure antidérapante, housse lavable à 30°C | Polyester, rembourrage (polyester) complètement amovible grâce à des fermetures éclair, hydrofuge, coussin intérieur amovible, partie inférieure antidérapante, housse lavable à 30°C | Polyester, relleno (poliéster) puede extraerse por completo gracias a su cremallera, repelente al agua, cojín interior extraíble, base antideslizante, funda lavable a 30°C | Polyester, l'imbottitura (poliestere) si può rimuovere completamente grazie alle cerniere incluse, idrorepellente, cuscino interno rimovibile, fondo antiscivolo, federa lavabile a 30°C | Polyester, fyld (polyester) kan tages helt ud ved hjælp af lynlåsen, vandafvisende, udtagelig inderpude, betræk vaskbar ved 30°C

beige | tan | beige | beige | beige

S 276058



Katzennapf VARA

Cat bowl | Gamelle pour chat | Cuenco para gatos | Ciotola per gatti | Katteskål

Melamin, rutschhemmende Unterseite, spülmaschinengeeignet | Melamine, non-slip bottom, dishwasher-safe | Mélamine, partie inférieure antidérapante, lavable au lave-vaisselle | Melamina, parte inferior antideslizante, apta para lavavajillas | Melamina, fondo antiscivolo, lavabile in lavastoviglie | Melamin, skridsikker underside, tåler opvaskemaskine

weiß | white | blanc | blanco | bianco | hvid

800 ml 276116

schwarz | black | noir | negro | nero | sort

800 ml 276117

▣ Ø III
800 ml 16 cm 2 Stck. | pcs.





☰	∅	
590 ml	15 cm	2 Stck. pcs.

Keramik-Katzennapf BELBO

Ceramic cat bowl | Gamelle pour chat en céramique | Comedero de cerámica para gatos | Ciotola per gatti in ceramica | Katteskål i keramik

Keramik/Bambus, ergonomische Höhe für Katzen, Gummistopper an der Unterseite, spülmaschinengeeignet | *Ceramic/bamboo, ergonomic height for cats, Rubber stopper at the bottom, dishwasher-safe* | Céramique/bambou, hauteur ergonomique pour chats, Butoirs en caoutchouc sur le dessous, lavable au lave-vaisselle | *Cerámica/bambú, altura ergonómica para gatos, Tapón de goma en la parte inferior, seguro para el lavavajillas* | Ceramica/bambù, altezza ergonomica per gatti, Tappo in gomma sul lato inferiore, lavabile in lavastoviglie | *Keramik/bambus, ergonomisk højde til katte, Gummiprop på undersiden, tåler opvaskemaskine*

weiß | white | blanc | blanco | bianco | hvid

590 ml 276110 

Keramik-Katzennapf TANARO

Ceramic cat bowl | Gamelle pour chat en céramique | Comedero de cerámica para gatos | Ciotola per gatti in ceramica | Katteskål i keramik

Keramik/Bambus, Gummistopper an der Unterseite, spülmaschinengeeignet | *Ceramic/bamboo, Rubber stopper at the bottom, dishwasher-safe* | Céramique/bambou, Butoirs en caoutchouc sur le dessous, lavable au lave-vaisselle | *Cerámica/bambú, Tapón de goma en la parte inferior, seguro para el lavavajillas* | Ceramica/bambù, Tappo in gomma sul lato inferiore, lavabile in lavastoviglie | *Keramik/bambus, Gummiprop på undersiden, tåler opvaskemaskine*

weiß | white | blanc | blanco | bianco | hvid

350 ml 276111 

☰	∅	
350 ml	18 cm	2 Stck. pcs.



☰	Ø	
150 ml	11 cm	2 Stck. pcs.

Keramik-Katzennapf OVADA

Ceramic cat bowl | Gamelle pour chat en céramique | Comedero de cerámica para gatos | Ciotola per gatti in ceramica | Katteskål i keramik

Keramik, Silikonrand am Boden ist rutschhemmend und beugt Kratzern auf dem Untergrund vor, spülmaschinengeeignet | *Ceramic, silicon edge stops the bowl from slipping and prevents your floor from being scratched, dishwasher-safe* | Céramique, le bord en silicone sur la partie inférieure est antidérapant et permet d'éviter les rayures sur le sol, lavable au lave-vaisselle | *Cerámica, con borde de silicona en la base para evitar que se deslice y que se raye la superficie inferior, seguro para el lavavajillas* | Ceramica, il bordo in silicone sul pavimento offre resistenza allo scivolamento e previene i graffi sulla superficie, lavabile in lavastoviglie | *Keramik, silikone kant på gulvet sikrer skridsikkerhed og forhindrer ridser på jorden, tåler opvaskemaskine*

weiß | white | blanc | blanco | bianco | hvid

150 ml 276112 

schwarz | black | noir | negro | nero | sort

150 ml 276113 

9 cm



☰	Ø	
90 ml	14 cm	2 Stck. pcs.

Keramik-Katzennapf LANGA

Ceramic cat bowl | Gamelle pour chat en céramique | Comedero de cerámica para gatos | Ciotola per gatti in ceramica | Katteskål i keramik

Keramik, ergonomische Höhe für Katzen, Silikonrand am Boden ist rutschhemmend und beugt Kratzern auf dem Untergrund vor, spülmaschinengeeignet | *Ceramic, ergonomic height for cats, silicon edge stops the bowl from slipping and prevents your floor from being scratched, dishwasher-safe* | Céramique, hauteur ergonomique pour chats, le bord en silicone sur la partie inférieure est antidérapant et permet d'éviter les rayures sur le sol, lavable au lave-vaisselle | *Cerámica, altura ergonómica para gatos, con borde de silicona en la base para evitar que se deslice y que se raye la superficie inferior, seguro para el lavavajillas* | Ceramica, altezza ergonomica per gatti, il bordo in silicone sul pavimento offre resistenza allo scivolamento e previene i graffi sulla superficie, lavabile in lavastoviglie | *Keramik, ergonomisk højde til katte, silikone kant på gulvet sikrer skridsikkerhed og forhindrer ridser på jorden, tåler opvaskemaskine*

weiß | white | blanc | blanco | bianco | hvid

90 ml 276114 

schwarz | black | noir | negro | nero | sort

90 ml 276115 



■ 57 x 38 x 15 cm ■■■ 2 Stck. | pcs.

Katzentoilette SILJAN

Cat toilet | Bac à litière pour chats | Bandeja sanitaria para gatos | Lettiera per gatti | Kattebakke

Kunststoff, puristsches Design, Staufach für Utensilien, pflegeleicht | *Plastic, purist design, storage compartment for utensils, easy to clean* | Plastique, design épuré, compartiment de rangement pour les ustensiles, facile d'entretien | *Plástico, diseño purista, compartimento para utensilios, fácil de limpiar* | *Plastica, design essenziale, scomparto per gli utensili, facile da pulire* | *Plast, puristisk design, opbevaringsrum til redskaber, let at rengøre*

weiß | white | blanc | blanco | bianco | hvid

276158 

Formschönes Design.
Elegant design.

Integriertes Staufach
für Utensilien.
*Integrated storage
compartment for utensils.*



Für eine bessere Grundreinigung
kann das Staufach schnell und einfach
entnommen werden.

*The storage compartment can be removed
quickly and easily for better basic cleaning.*



Katzentoilette OLIGO

Cat toilet | Bac à litière pour chats | Bandeja sanitaria para gatos | Lettiera per gatti | Kattebakke

Melamin, puristisches Design, geringerer Streuverbrauch und höhere Langlebigkeit gegenüber anderen Katzentoiletten, sehr leicht, pflegeleicht | *Melamine, purist design, lower litter consumption and greater durability compared to other litter trays, very light, easy to clean* | Mélamine, design épuré, faible consommation de litière et plus grande longévité par rapport aux autres bacs à litière, très léger, facile d'entretien | *Melamina, diseño purista, menor consumo de arena y mayor durabilidad en comparación con otras bandejas sanitarias, muy ligera, fácil de limpiar* | In melamina, design purista, minore consumo di rifiuti e maggiore durata rispetto ad altre vaschette per rifiuti, molto leggera, facile da pulire | *Melamin, puristisk design, lavere katteforbrug og større holdbarhed sammenlignet med andre kattebakker, meget let, nem at rengøre*

weiß/hellgrau | white/light grey | blanc/gris clair | blanco/gris claro | bianco/grigio chiaro | hvid/lysegrå

276160 

■ 58 x 40 x 19 cm IIII 2 Stck. | pcs.

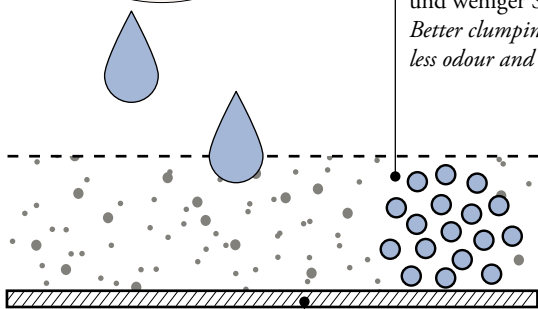
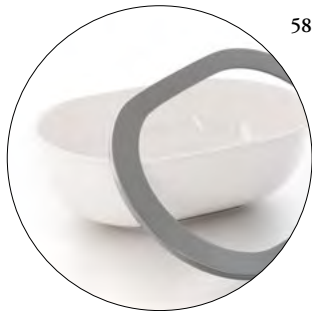

Bessere Verklumpung, dadurch weniger Geruchsaufkommen und weniger Streugut-Einsatz.
Better clumping, resulting in less odour and less spreading.

Melamin

Hochwertigere und härtere Oberfläche bei Melamin gegenüber herkömmlichem Plastik.

Higher quality and harder surface with melamine compared to conventional plastic.

Weniger Kratzer durch Scharren am Wannenhoden.
Fewer scratches due to scraping on the floor of the tub.

Standard plastic

Dank unserer speziellen Formel für das Melaminmaterial erleben Sie eine verbesserte Verklumpung von Katzenstreu. Dies bedeutet weniger Geruchsbildung und eine Reduzierung des Streueinsatzes, sodass Sie und Ihre Katze eine frische und saubere Umgebung genießen können. Die Oberfläche aus Melamin bietet nicht nur eine unübertroffene Haltbarkeit, sondern auch eine härtere und glattere Oberfläche im Vergleich zu herkömmlichem Plastik. Das bedeutet weniger Kratzer und Abnutzungerscheinungen im Wannenhoden, selbst wenn Ihre Katze ausgiebig scharren sollte.

Thanks to our special formula for the melamine material, you will experience improved clumping of cat litter. This means less odour build-up and a reduction in litter use, so you and your cat can enjoy a fresh and clean environment. The melamine surface not only offers unrivalled durability, but also a harder and smoother surface compared to traditional plastic. This means less scratching and scuffing of the base of the tray, even if your cat scratches extensively.

-  **Bessere Verklumpung**
Better clumping
-  **Weniger Streugut-Einsatz**
Less grit used
-  **Weniger Geruchsbildung**
Less odour formation
-  **Geringes Gewicht**
Low weight
-  **Robustes Melamin-Material**
Robust melamine material
-  **Weniger Grundreinigung**
Less basic cleaning
-  **Weniger Kratzspuren**
Less scratch marks
-  **Einzigartiges Design**
Unique design



III
3 Stck. | pcs.

Katzenspielzeug ROLLI

*Cat toy | Jouet pour chats | Juguete para gatos | Giocattolo per gatti
| Kattelegetøj*

Wollfilz, warmes und ansprechendes Spielzeug | *Wool felt, warm and appealing toy* | Feutre de laine, jouets chauds et attrayants | *Fieltro de lana, juguete cálido y atractivo* | Giocattolo in feltro di lana, caldo e accattivante | *Uldfilt, varmt og tiltalende legetøj*

1: grau-weiß | grey-white | gris-blanc | gris-blanco | grigio-bianco | grå-hvid

3,5 cm 277105

2: bunt | colourful | multicolore | colorido | colorato | farverig

3,5 cm 277104

Katzenspielzeug SNAKY

*Cat toy | Jouet pour chats | Juguete para gatos | Giocattolo per gatti
| Kattelegetøj*

Wollfilz, warmes und ansprechendes Spielzeug | *Wool felt, warm and appealing toy* | Feutre de laine, jouets chauds et attrayants | *Fieltro de lana, juguete cálido y atractivo* | Giocattolo in feltro di lana, caldo e accattivante | *Uldfilt, varmt og tiltalende legetøj*

1: weiß | white | blanc | blanco | bianco | hvid

115 cm 277119

2: pink | pink | rose | rosa | rosa carico | pink

115 cm 277116

3: hellgrau | light grey | gris clair | gris claro | grigio chiaro | lysegrå

115 cm 277113

4: anthrazit | anthracite | anthracite | anthracita | anthracite | antracit

115 cm 277108

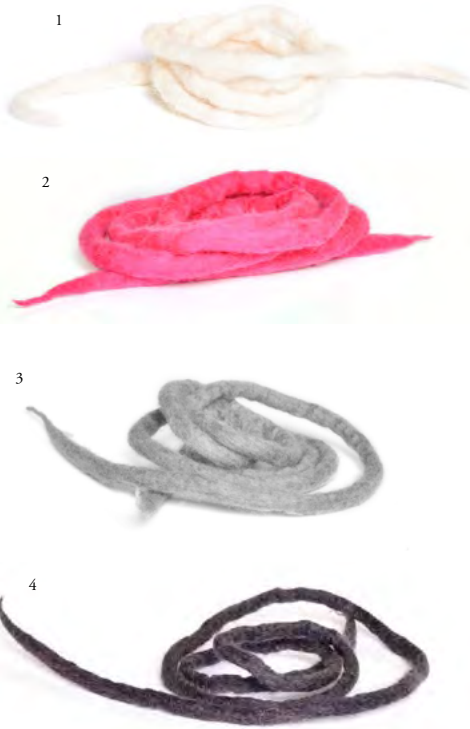

III
3 Stck. | pcs.

3er Set
Set of 3

assorted colours

III
3 Stck. | pcs.

Katzenspielzeug MINIBALL

Cat toy | Jouet pour chats | Juguete para gatos | Giocattolo per gatti
| Kattelegetøj

Wollfilz, warmes und ansprechendes Spielzeug | Wool felt, warm and appealing toy | Feutre de laine, jouets chauds et attrayants | Fieltro de lana, juguete cálido y atractivo | Giocattolo in feltro di lana, caldo e accattivante | Uldfilt, varmt og tiltalende legetøj

2,5 cm 277082

III
3 Stck. | pcs.

Katzenspielzeug FILZRING

Cat toy | Jouet pour chats | Juguete para gatos | Giocattolo per gatti
| Kattelegetøj

Wollfilz, warmes und ansprechendes Spielzeug | Wool felt, warm and appealing toy | Feutre de laine, jouets chauds et attrayants | Fieltro de lana, juguete cálido y atractivo | Giocattolo in feltro di lana, caldo e accattivante | Uldfilt, varmt og tiltalende legetøj

1: weiß | white | blanc | blanco | bianco | hvid

7 cm 277068

2: hellgrau | light grey | gris clair | gris claro | grigio chiaro | lysegrå

7 cm 277067

3: bunt | colourful | multicolore | colorido | colorato | farverig

7 cm 277066

3er Set
Set of 33er Set
Set of 3

assorted colours

III
3 Stck. | pcs.

Katzenspielzeug BOMBS

Cat toy | Jouet pour chats | Juguete para gatos | Giocattolo per gatti
| Kattelegetøj

Wollfilz, warmes und ansprechendes Spielzeug | Wool felt, warm and appealing toy | Feutre de laine, jouets chauds et attrayants | Fieltro de lana, juguete cálido y atractivo | Giocattolo in feltro di lana, caldo e accattivante | Uldfilt, varmt og tiltalende legetøj

1: grau | grey | gris | gris | grigio | grå

13 cm 277001

2: bunt | colourful | multicolore | colorido | colorato | farverig

13 cm 277000





III
3 Stck. | pcs.

Katzenspielzeug KWALLE KARL

Cat toy | Jouet pour chats | Juguete para gatos | Giocattolo per gatti | Kattelegetøj

Wollfilz, warmes und ansprechendes Spielzeug | *Wool felt, warm and appealing toy* | Feutre de laine, jouets chauds et attrayants | *Fieltro de lana, juguete cálido y atractivo* | Giocattolo in feltro di lana, caldo e accattivante | *Uldfilt, varmt og tiltalende legetøj*

weiß | white | blanc | blanco | bianco | hvid

10 cm 277203 



Gesamtlänge:
Total length:
140 cm



III
3 Stck. | pcs.

Katzenspielzeug HECHT

Cat toy | Jouet pour chats | Juguete para gatos | Giocattolo per gatti | Kattelegetøj

Wollfilz, warmes und ansprechendes Spielzeug | *Wool felt, warm and appealing toy* | Feutre de laine, jouets chauds et attrayants | *Fieltro de lana, juguete cálido y atractivo* | Giocattolo in feltro di lana, caldo e accattivante | *Uldfilt, varmt og tiltalende legetøj*

1: blau | blue | bleu | azul | blu | blå

3 cm 277215 

2: hellgrau | light grey | gris clair | gris claro | grigio chiaro | lysegrå

3 cm 277216 



III
3 Stck. | pcs.

Katzenspielzeug OCTI OTTO

*Cat toy | Jouet pour chats | Juguete para gatos | Giocattolo per gatti
| Kattelegetøj*

Wollfilz, warmes und ansprechendes Spielzeug | *Wool felt, warm and appealing toy* | Feutre de laine, jouets chauds et attrayants | *Fieltro de lana, juguete cálido y atractivo* | Giocattolo in feltro di lana, caldo e accattivante | *Uldfilt, varmt og tiltalende legetøj*

pink | pink | rose | rosa | rosa carico | pink

16 cm 277211 



III
3 Stck. | pcs.

Katzenspielzeug MOUSI LONG

*Cat toy | Jouet pour chats | Juguete para gatos | Giocattolo per gatti
| Kattelegetøj*

Wollfilz, warmes und ansprechendes Spielzeug | *Wool felt, warm and appealing toy* | Feutre de laine, jouets chauds et attrayants | *Fieltro de lana, juguete cálido y atractivo* | Giocattolo in feltro di lana, caldo e accattivante | *Uldfilt, varmt og tiltalende legetøj*

hellgrau | light grey | gris clair | gris claro | grigio chiaro | lysegrå

70 cm 277210 

KONG®

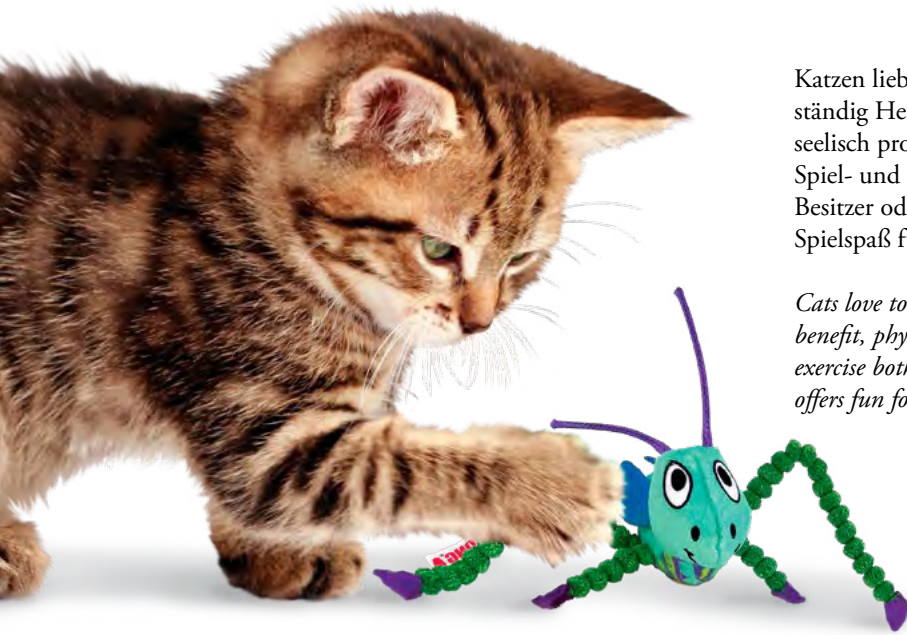

Katzen lieben es, Beute hinterher zu jagen und selbstständig Herausforderungen zu begegnen. Körperlich und seelisch profitieren die Samtpfoten von regelmäßigen Spiel- und Bewegungseinheiten gemeinsam mit Ihrem Besitzer oder auch allein. Das KONG®-Sortiment bietet Spielspaß für jeden Tag und für alle »sieben Sinne«.

Cats love to hunt prey and meet challenges on their own. Cats benefit, physically and psychologically, from regular play and exercise both with their owner or alone. The KONG® range offers fun for every day and for all »seven senses«.



CATNIP

Catnip Spray KONG® NATURALS

Catnip-Öl zum Besprühen von Katzenspielzeug | *Catnip oil for spraying onto the cat's toy* | Huile de catnip pour vaporisation sur des jouets pour chats | *Aceite de catnip para pulverizar sobre el juguete del gato* | Olio di catnip da spruzzare sul giocattolo per gatti | *Catnipolie til at sprøjte på kattelagetøj*

30 ml 46624 



III
3 Stck. | pcs



■: 22 x 27 cm IIII 2 Stck. | pcs.

Katzenspielzeug KONG® CAT PUZZLEMENTS™ PIE

Cat toy | Jouet pour chats | Juguete para gatos | Giocattolo per gatti
| Kattelegetøj

Polyester, mit Knistergeräuschen, mit Catnip, 6-teilig | Polyester, with crackling sounds, with catnip, 6 pieces | Polyester, avec bruits de crépitement, avec catnip, 6 pièces | Poliéster, con sonidos crepitantes, con hierba gatera, 6 piezas | Poliester, con suoni scoppiettanti, con erba gatta, 6 pezzi | Polyester, med knitrende lyde, med kattegræs, 6 stk

69538 



■: 10 x 13,5 cm IIII 2 Stck. | pcs.

Katzenspielzeug KONG® CATNIP INFUSER

Cat toy | Jouet pour chats | Juguete para gatos | Giocattolo per gatti
| Kattelegetøj

ABS/Polyester, mit Catnip, zum Auffrischen von Spielzeug, mit 6 Plüschbällen | ABS/polyester, with catnip, for refreshing toys, with 6 plush balls | ABS/Polyester, avec catnip, pour rafraîchir les jouets, avec 6 balles en peluche | ABS/Poliéster, con hierba gatera, para refrescar los juguetes, con 6 pelotas de felpa | ABS/Poliester, con erba gatta, per rinfrescare i giocattoli, con 6 palline di peluche | ABS/Polyester, med kattegræs, til forfriskende legetøj, med 6 physbolde

69713 



Catnip-Auffrischung

Durch die Löcher des Bodens, der mit hochwertiger Katzenminze gefüllt ist, strömt deren unwiderstehlicher Duft, den die sechs enthaltenen bunten Plüschbälle annehmen und dadurch besonders interessant für alle Samtpfoten werden.

Catnip refresher. The irresistible scent of catnip flows through the holes in the base, which is filled with high-quality catnip, and the six colourful plush balls inside take on the scent, making them particularly interesting for all velvet paws.



Katzenspielzeug KONG® WRANGLER CACTUS

Cat toy | Jouet pour chats | Juguete para gatos | Giocattolo per gatti
| Kattelegetøj

Polyester, mit Knistergeräuschen, mit Catnip | Polyester, with crackling sounds, with catnip | Polyester, avec bruits de crépitement, avec catnip | Poliester, con sonidos crepitantes, con hierba gatera | Poliestere, con suoni scoppiettanti, con erba gatta | Polyester, med knitrende lyde, med kattegræs

22 cm 69714 

Voller Körpereinsatz

Kaktus und Topf sind nur durch ein Gummiband miteinander verbunden, so dass sie vom tobenden Stubentiger auseinandergezogen werden können, ohne dass Einzelteile verloren gehen.

Full body effort. The cactus and the pot are only connected by a rubber band so that they can be pulled apart by the frolicking cat without losing any of the individual parts.

III
3 Stck. | pcs.



Katzenspielzeug KONG® WRANGLER ANGLER FISH

Cat toy | Jouet pour chats | Juguete para gatos | Giocattolo per gatti
| Kattelegetøj

Polyester, mit Knistergeräusch, mit Federn, mit Catnip, farblich sortiert | Polyester, with crackling sound, with feathers, with catnip, assorted colours | Polyester, avec bruit de crépitement, avec plumes, avec catnip, couleurs assorties | Poliester, con sonido crepitante, con plumas, con hierba gatera, colores surtidos | Poliestere, con suono scoppiettante, con piume, con erba gatta, colori assortiti | Polyester, med knitrende lyd, med fjer, med katteurt, assorterede farver

54 cm 207553 

assorted colours
III
3 Stck. | pcs.



CATNIP



III
3 Stck. | pcs.

Katzenspielzeug KONG® CONNECTS PEACOCK

Cat toy | Jouet pour chats | Juguete para gatos | Giocattolo per gatti
| Kattelgetoj

Polyester, mit Federn, mit Catnip | Polyester, with feathers, with catnip
| Polyester, avec plumes, avec catnip | Poliéster, con plumas, con catnip
| Poliestere, con piume, con erba gatta | Polyester, med fjer, med katteurt

45 cm 207625 



assorted colours III
3 Stck. | pcs.

Katzenspielzeug KONG® ACTIVE BUBBLE BALL

Cat toy | Jouet pour chats | Juguete para gatos | Giocattolo per gatti
| Kattelgetoj

Polyester, mit Federn, mit innenliegendem Glöckchen, farblich sortiert
| Polyester, with feathers, with internal bell, assorted colours | Polyester,
avec plumes, avec clochette intérieure, couleurs assorties | Poliéster, con
plumas, con cascabel interior, colores surtidos | Poliestere, con piume, con
campanellino interno, colori assortiti | Polyester, med fjer, med indvendig
klokke, assorterede farver

21 cm 207601 





III
3 Stck. | pcs.

Katzenspielzeug KONG® CRACKLES GRASSHOPPER

Cat toy | Jouet pour chats | Juguete para gatos | Giocattolo per gatti
| Kattelegetøj

Polyester, mit Knistergeräusch, mit innenliegendem Glöckchen, mit Catnip | Polyester, with crackling sound, with inside bell, with catnip | Polyester, avec bruit de crépitement, avec clochette intérieure, avec catnip | Poliéster, con sonido crepitante, con cascabel interior, con hierba gatera | Poliestere, con suono scoppiettante, con campana interna, con erba gatta | Polyester, med knitrende lyd, med indvendig klokke, med katteurt

15 cm 207568 



III
14 x 6 cm 3 Stck. | pcs.

Katzenspielzeug KONG® PULL-A-PARTZ™ SUSHI

Cat toy | Jouet pour chats | Juguete para gatos | Giocattolo per gatti
| Kattelegetøj

Polyester, mit Knistergeräuschen, mit Catnip, 5-teilig | Polyester, with crackling sounds, with catnip, 5 pieces | Polyester, avec bruits de crépitement, avec catnip, 5 pièces | Poliéster, con sonidos crepitantes, con hierba gatera, 5 piezas | Poliestere, con suoni scoppiettanti, con erba gatta, 5 pezzi | Polyester, med knitrende lyde, med kattedegres, 5 stk

69540 



III
3 Stck. | pcs.

Katzenspielzeug KONG® PULL A PARTZ™ PINATA

Cat toy | Jouet pour chats | Juguete para gatos | Giocattolo per gatti
| Kattelegetøj

Polyester/Kunststoff, mit Knistergeräuschen, mit Catnip | Polyester/
Plastic, with crackling sounds, with catnip | Polyester/Plastique, avec
bruits de crépitement, avec catnip | Poliéster/Plástico, con sonidos crepi-
tantes, con hierba gatera | Poliestere/Plastica, con suoni scoppiettanti,
con erba gatta | Polyester/Plast, med knitrende lyde, med kattegræs

12 cm 69715 

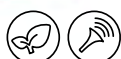

III
4 Stck. | pcs.

Katzenspielzeug KONG® PULL-A-PARTZ™ YARNZ

Cat toy | Jouet pour chats | Juguete para gatos | Giocattolo per gatti
| Kattelegetøj

Polyester, mit Knistergeräuschen, mit Catnip, farblich sortiert |
Polyester, with crackling sounds, with catnip, assorted colours | Polyester,
avec bruits de crépitement, avec catnip, couleurs assorties | Poliéster,
con sonidos crepitantes, con hierba gatera, colores variados, colores surtidos
| Poliestere, con suoni scoppiettanti, con erba gatta, colori assortiti |
Polyester, med knitrende lyde, med kattegræs, farvemæssigt sorteret

12 cm 69724 

assorted colours



Katzenspielzeug KONG® TEASER LOOPZ

Cat toy | Jouet pour chats | Juguete para gatos | Giocattolo per gatti
| Kattelegetøj

Polyester, mit Knistergeräuschen, mit Federn, mit Catnip | Polyester, with crackling sounds, with feathers, with catnip | Polyester, avec bruits de crépitement, avec plumes, avec catnip | Poliéster, con sonidos crepitantes, con plumas, con hierba gatera | Poliestere, con suoni scoppiettanti, con piume, con erba gatta | Polyester, med knitrende lyde, med fjer, med kattegræs

140 cm 69712 

III
2 Stck. | pcs.



Katzenspielzeug KONG® TEASER JELLYFISH

Cat toy | Jouet pour chats | Juguete para gatos | Giocattolo per gatti
| Kattelegetøj

Polyester, mit Knistergeräusch, mit Glöckchen, mit Federn, mit Catnip, farblich sortiert | Polyester, with crackling sound, with bell, with feathers, with catnip, assorted colours | Polyester, avec bruit de crépitement, avec clochette, avec plumes, avec catnip, couleurs assorties | Poliéster, con sonido crepitante, con cascabel, con plumas, con hierba gatera, colores surtidos | Poliestere, con suono scoppiettante, con campana, con piume, con erba gatta, colori assortiti | Polyester, med knitrende lyd, med klokke, med fjer, med katteurt, assorterede farver

15 cm 207616 

assorted colours III
3 Stck. | pcs.



Katzenspielzeug KONG® TROPICS

Cat toy | Jouet pour chats | Juguete para gatos | Giocattolo per gatti
| Kattelegetøj

Polyester/PVC, mit Knistergeräuschen, mit Catnip, | Polyester/PVC, with crackling sounds, with catnip | Polyester/PVC, avec bruits de crépitement, avec catnip | Poliéster/PVC, con sonidos crepitantes, con hierba gatera | Poliestere/PVC, con suoni scoppiettanti, con erba gatta | Polyester/PVC, med knitrende lyde, med kattegræs

1: Flamingo | Flamingo | Flamant | Flamenco | Fenicottero | Flamingo

30 cm 69716 

2: Hula

15 cm 69717 



III
3 Stck. | pcs.



Katzenspielzeug KONG® PLAY SPACES CLOUD

Cat toy | Jouet pour chats | Juguete para gatos | Giocattolo per gatti
| Kattelegetøj

Polyester, beidseitig verwendbare Spiel- und Wellness-Matte, mit Knistergeräuschen, mit Catnip, Handwäsche | Polyester, double-sided play and wellness mat, with crackling sounds, with catnip, hand washable | Polyester, tapis de jeu et de bien-être réversible, avec bruits de crépitement, avec herbe à chat, lavable à la main | Poliéster, de doble cara, para jugar y para el bienestar, con sonidos crepitantes, con hierba gatera, lavable a mano | Poliestere, tappetino double-face per il gioco e il benessere, con suoni scoppiettanti, con erba gatta, lavabile a mano | Polyester, dobbeltsidet lege- og wellnessmätte, med knitrende lyde, med kattegræs, håndvaskbar

69656 



I
60 x 45 cm III
2 Stck. | pcs.

Verkaufshilfen

— *Sales Promotions* —

Die Verkaufshilfen von HUNTER ermöglichen eine individuelle und übersichtliche Warenpräsentation am POS. Das bewährte System zeichnet sich durch große Flexibilität und eine einfache Montage.

The HUNTER sales supports facilitate the individual and clear presentation of goods at the POS. The reliable system is characterised by its extreme flexibility and simple assembly.





MADE
IN
GERMANY

Katalog HUNTER Vol. XII

Catalogue | Catalogue | Catálogo | Catalogo | Katalog

gegliederte Gesamtsortimentsübersicht | *structured total assortment overview* | un aperçu structuré de la gamme complète | *una visión general estructurada de la gama completa* | panoramica strutturata della gamma completa | struktureret oversigt over hele serien

00020 



Passgenau für 2 Europaletten
perfectly fitting for 2 euro-pallets

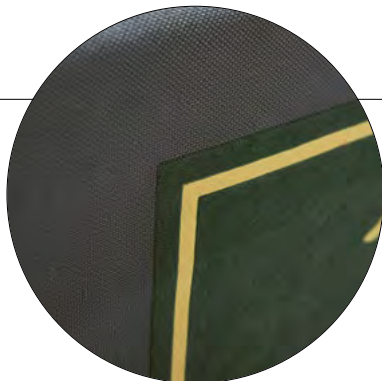

■
120 x 80 x 30 cm

Paletten-Husse

Pallet cover | *Couvertures de palettes* | *Cubiertas de paletas* | *Copertura per pallet* | *Palleovertræk*

Polyester, passend für Euro-Paletten in zwei Stapelhöhen, ansprechende Präsentationsfläche, einfache Handhabung, mit HUNTER-Logo | *Polyester, adapté aux euro-palettes en deux hauteurs d'empilage, surface de présentation attrayante, manipulation facile, avec logo HUNTER* | Polyester, adapté aux euro-palettes en deux hauteurs d'empilage, surface de présentation attrayante, manipulation facile, avec logo HUNTER | *Poliéster, apto para europaletas en dos alturas de apilamiento, superficie de presentación atractiva, fácil manejo, con el logo de HUNTER* | Poliesterre, adatto per europallet in due altezze di impilamento, superficie di presentazione attraente, facile da maneggiare, con logo HUNTER | *Polyester, velegnet til Euro-paller i to stablingshøjder, attraktivt præsentationsområde, let håndtering, med HUNTER-logo*

anthrazit | anthracite | anthracite | anthracita | anthracite | antracit

68715 



PASSEND FÜR 1,25 M
suitable for 1,25 m



Mantelstange

Coat rod | Barre de manteau | Barra de la vaina | Barra della guaina | Skede stang

Stahl, zur ansprechenden Präsentation von Hundebekleidung, geschwungene Form, einfache Handhabung, passend für 125 cm Rückwand | Steel, for attractive presentation of dog clothing, curved shape, easy handling, fits 125 cm back wall | Acier, pour une présentation attrayante des vêtements pour chiens, forme incurvée, manipulation simple, adapté au panneau arrière de 125 cm | Acero, para una presentación atractiva de la ropa del perro, forma curvada, fácil de manejar, se adapta a una pared trasera de 125 cm | Acciaio, per una presentazione attraente dell'abbigliamento per cani, forma curva, facile da maneggiare, si adatta alla parete posteriore di 125 cm | Stål, til attraktiv presentation af hundetøj, buet form, nem håndtering, passer til 125 cm bagveg

69304 

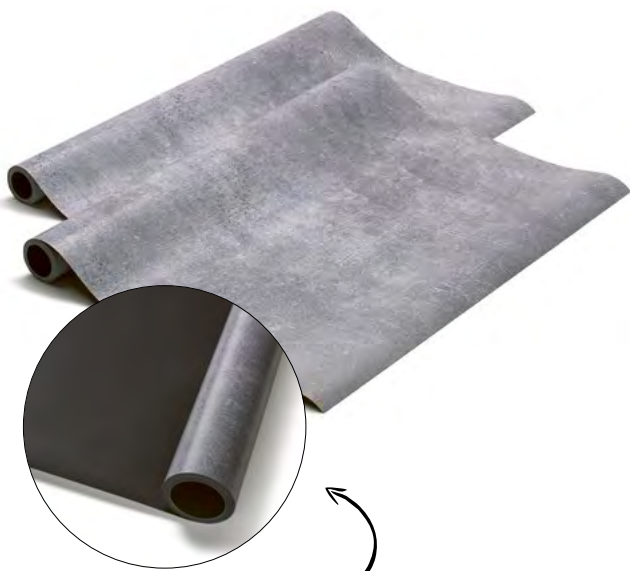

2-teilig, passend für 1,25 m Rückwand
2-piece, suitable for 1.25 m rear wall

Magnet-Folie für Rückwände



Magnetic foil for back panels | Feuille magnétique pour les panneaux arrière | Lámina magnética para los paneles traseros | Lamina magnetica per i pannelli posteriori | Magnetisk folie til bagvegge

PVC, magnetische Folie, passend für 1,25 m Rückwand, edel anmutende Beton-Optik, einfache Handhabung | PVC, magnetic foil, suitable for 1.25 m rear wall, noble concrete look, easy handling | PVC, feuille magnétique, adaptée au mur arrière de 1,25 m, aspect béton noble, manipulation facile | PVC, lámina magnética, adecuada para la pared trasera de 1,25 m, aspecto de hormigón noble, fácil manejo | PVC, pelli-cola magnetica, adatta per parete posteriore di 1,25 m, aspetto nobile in cemento, facile da maneggiare | PVC, magnetfolie, velegnet til 1,25 m bagveg, elegant betonudseende, let at bruge

grau | grey | gris | gris | grigio | grå

68597 



 1 x 2 Stck. | pcs.  220 x 61,85 cm

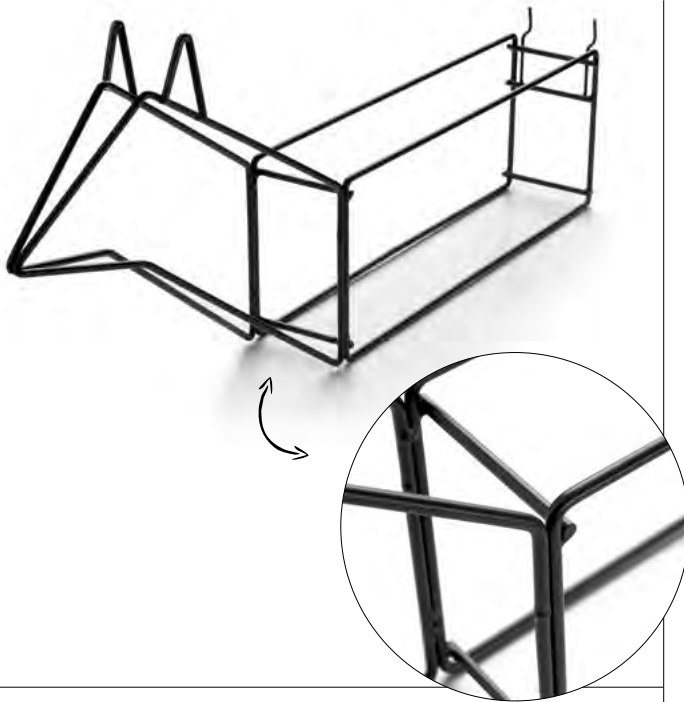

55 x 10 x 20 cm



Hundekorpus zur Bekleidungspräsentation

Dog carcass for clothing presentation | Corps de chien pour la présentation de vêtements | Carcasa de perro para presentación de ropa | Carcassa di cane per la presentazione dell'abbigliamento | Hundekadaver til præsentation af tøj

Stahl, zur anschaulichen Präsentation saisonaler Bekleidungs-Highlights, optimiert für Gr. 35 des HUNTER-Sortiments, einfache Handhabung, passend für alle Rückwand-Varianten (100 cm, 125 cm) | *Steel, for attractive presentation of seasonal clothing highlights, optimised for size 35 of the HUNTER range, easy to use, suitable for all back panel variants (100 cm, 125 cm)* | Acier, pour une présentation claire des points forts de la saison en matière de vêtements, optimisé pour la taille 35 de la gamme HUNTER, manipulation simple, adapté à toutes les variantes de panneaux arrière (100 cm, 125 cm) | *Acero, para una presentación vivida de las prendas más destacadas de la temporada, optimizado para la talla 35 de la gama HUNTER, fácil de manejar, adecuado para todas las variantes de pared trasera (100 cm, 125 cm)* | Acciaio, per una vivace presentazione dei capi di abbigliamento stagionali, ottimizzato per la taglia 35 della gamma HUNTER, facile da maneggiare, adatto a tutte le varianti di parete posteriore (100 cm, 125 cm) | *Stål, til levende præsentation af sæsonens tøjhøjdepunkter, optimeret til størrelse 35 i HUNTER-sortimentet, nem håndtering, passer til alle bagvægsvarianter (100 cm, 125 cm)*

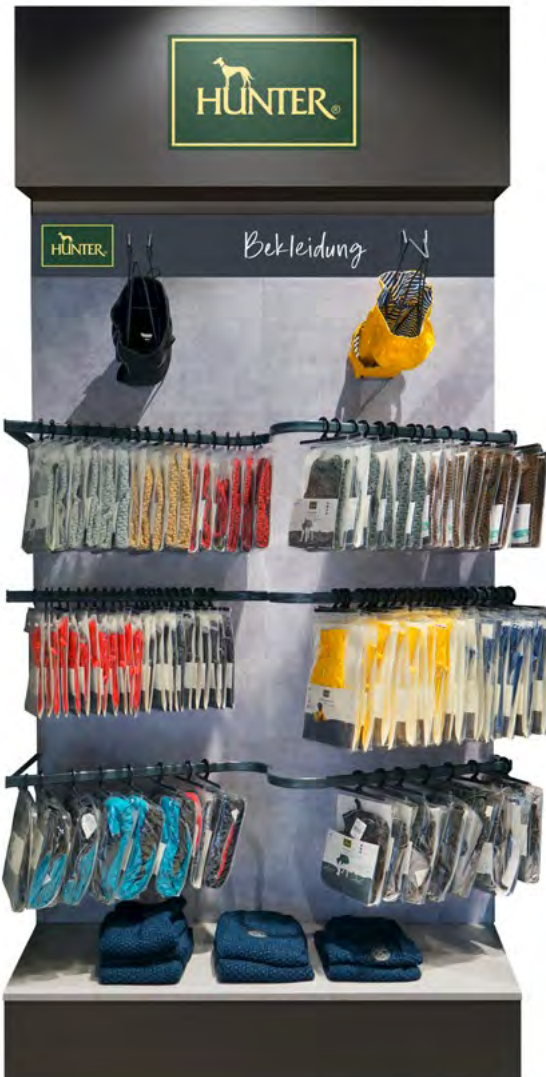
69309 



-  Für die Lochwand geeignet
Suitable for the perforated wall
-  Einfache Handhabung
Easy to use
-  Minimalistisches Design
Minimalist design

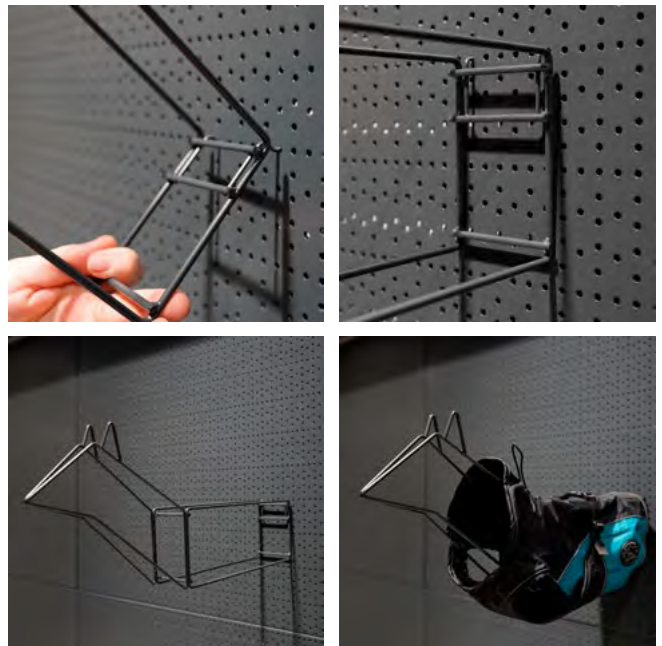



MADE
IN
GERMANY



■
38 x 8 x 8 cm

HILO
Perfect
MATCH

Hakenleiste zur Produktpräsentation

Hook rail for product presentation | Barre à crochets pour la présentation des produits | Barra de enganche para la presentación de productos | Guida a gancio per la presentazione del prodotto | Krogskinne til produktpräsentation

Stahl, zur übersichtlichen Präsentation aller Größen der HILO-Geschirre | *Steel, for clear presentation of all sizes of HILO harnesses* | Acier, pour une présentation claire de toutes les tailles de harnais HILO | *Acero, para una presentación clara de todos los tamaños de arnés HILO* | Acciaio, per una presentazione chiara di tutte le dimensioni dei pettorina HILO | *Stål, til tydelig presentation af alle størrelser af HILO-sele*

69704 

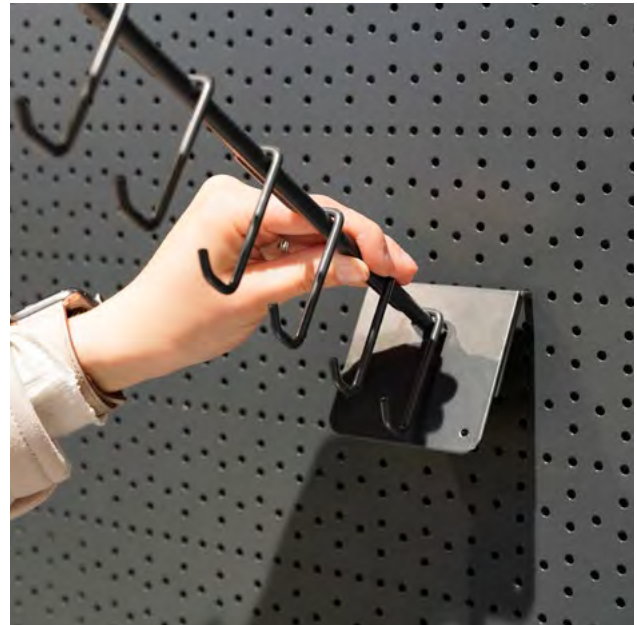

Praktische Hakenleiste,
konzipiert für HILO-Geschirre
*Practical hook rail, designed for
HILO harnesses*



Ermöglicht die übersichtliche
Präsentation aller acht Größen
Enables clear presentation of all eight sizes



Einzelne Artikel können mit einem
Handgriff entnommen werden
*Individual items can be removed
with a flick of the wrist*



Kompatibel mit allen gängigen
Lochwandsystemen
*Compatible with all standard
perforated wall systems*



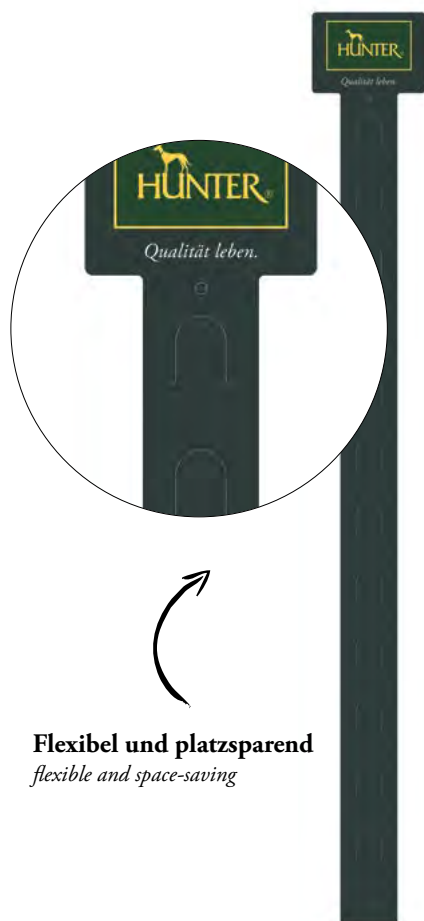

Flexibel und platzsparend
flexible and space-saving

■
95 x 12 cm



|||| 10 Stck. | pcs. ■ 45 x 33 x 10 cm

Clipstrip

Polypropylen, unbestückt, mit 12 Haltern, mit HUNTER-Logo
| Polypropylene, unequipped, with 12 holders, with HUNTER logo |
Polypropylène, déchargé, avec 12 supports, avec le logo HUNTER
| Polipropileno, descargado, con 12 soportes, con el logo de HUNTER
| Polipropilene, scaricata, con 12 supporti, con logo HUNTER |
Polypropylen, tom, med 12 holdere, med HUNTER-logo

66878 

Shopper Bag HUNTER

Baumwolle, OEKO-TEX®-zertifiziert, mit Bodenfalte für mehr Volumen, mit HUNTER-Print | Cotton, OEKO-TEX®-certified, with bottom gusset for more volume, with HUNTER print | Coton, certifié OEKO-TEX®, avec soufflet de fond pour plus de volume, avec imprimé HUNTER | Algodón, certificado OEKO-TEX®, con pliegue inferior para mayor volumen, con estampado HUNTER | Cotone, certificato OEKO-TEX®, con piega sul fondo per aumentare il volume, con stampa HUNTER | Bomuld, OEKO-TEX®-certificeret, med bundfold for mere volumen, med HUNTER-print

69552 



⇒ 
 S 18 x 100 cm
 M 18 x 125 cm

Magnet-Banner

Magnetic banner | Bannière magnétique | Bandera magnética | Banner magnetico | Magnetbanner

magnetischer Banner für beispielsweise Lochwände | magnetic banner for perforated walls, for example | bannière magnétique pour, par exemple, les murs perforés | banderas magnéticas para, por ejemplo, paredes perforadas | banner magnetico per es. pareti forate | magnetisk banner til for eksempel perforerede vægge

Training

S 49671  M 49666 

Näpfe

S 49673  M 49668 

Spielzeug

S 49672  M 49667 

Outdoor

S 49674  M 49669 

Lederartikel

M 69498 

SMART Halsbänder & Leinen

M 49682 

Welpen

M 49685 

kleine Hunde

M 49686 

Geschirre

M 49687 

Collars & Leashes

S 49679  M 49676 

Toys

S 49680  M 49677 

Bowls

S 49681  M 49678 

Schlafplätze

S 49688 

Pflege

S 49689  M 49692 

Leuchtartikel

M 49690 

Bekleidung

M 49691 

Upcycled & Recycled

M 49693 

Harnesses | Harnesses | Harnesses | Harnesses

S 69550  M 69551 

Magnet-Banner
Magnetic banner

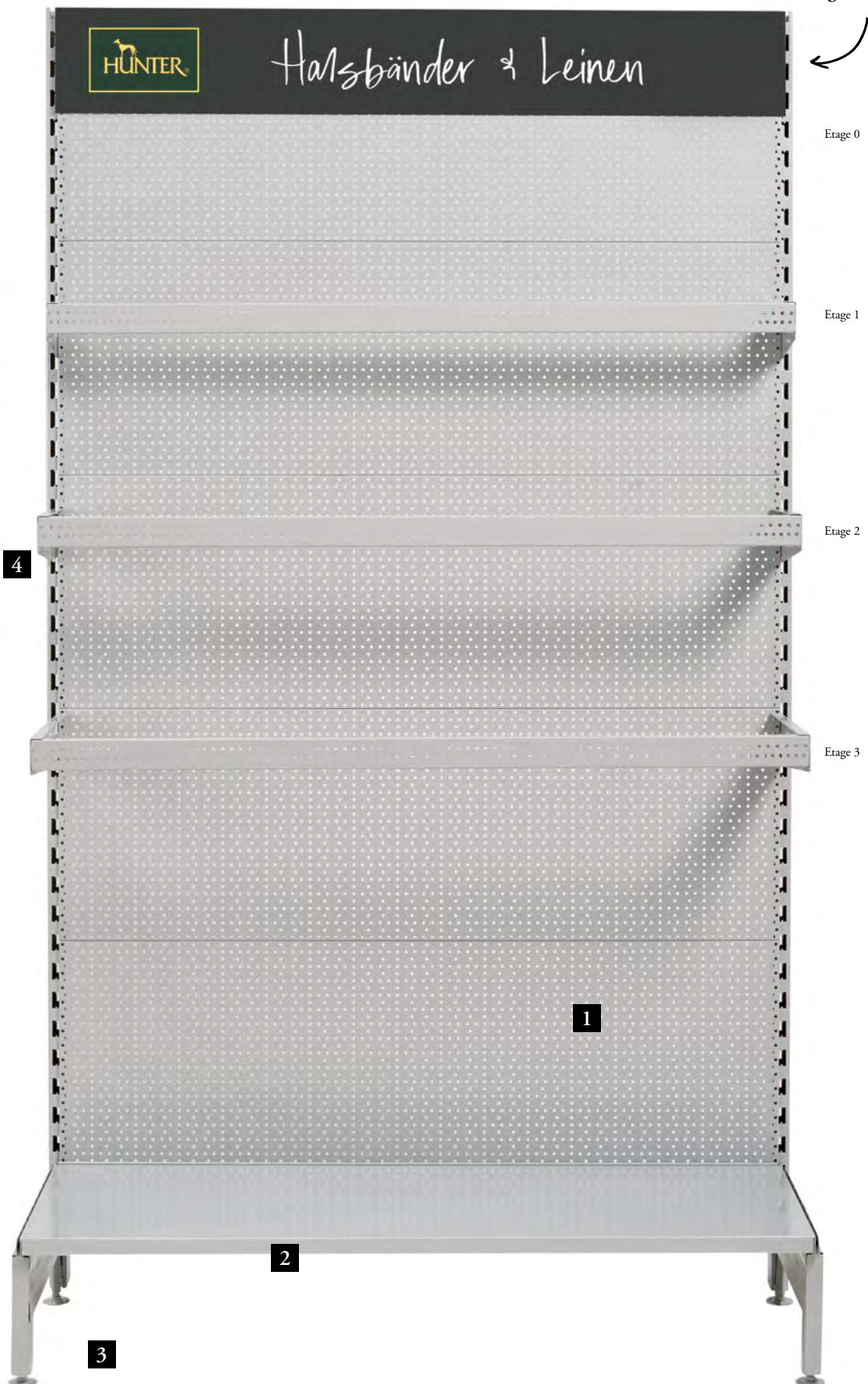



Warenträgersystem

Presentation for Tego | Présentation de Tego | Presentación de Tego | Presentazione per Tego | Præsentation til Tego

grau | grey | gris | gris | grigio | grå

100 cm

1. Etage 45211 

2. Etage 45214 

3. Etage 45217 

125 cm

1. Etage 45212 

2. Etage 45215 

3. Etage 45218 

anthrazit beschichtet | *anthracite surface* | couleur anthracite | *revestimiento en antracita* | rivestito di antracite | *antracitfarvet belægning*

125 cm

0. Etage 64627 

1. Etage 64628 

2. Etage 64629 

3. Etage 64630 

⇒	■i
0. Etage	125 x 4 cm
1. Etage	100/125 x 16 cm
2. Etage	100/125 x 26 cm
3. Etage	100/125 x 36 cm

1: Rückwand Rundlochung

Rear wall round punching | Poinçon rond de mur arrière | Perforación redonda de la pared posterior | Pannello posteriore foratura rotonda | Bagvæg med runde huller

100 45112 

125 45113 

Lochplattenhaken SIMPLE

Perforated plate hook | Crochets pour panneau perforé | Ganci per pannello forato | Ganchos de panel perforado | Hulpladekroge

leicht zu befestigen und individuell auswechselbar | *easy to fix and individually exchangeable* | facile à fixer et à arranger à votre guise | *facil de fijar, se puede sustituir de forma individual* | facile da fissare e sostituibile individualmente | *nem fastgøring, kan udskiftes individuelt*

S 45039 

M 45552 

⇒	■i	■■■
S	120 mm	50 Stck. pcs.
M	200 mm	30 Stck. pcs.

Doppelhaken

Double hook | Crochet de doubles | Gancho de los dobles | Doppio gancio | Dobbelt hage

glanzverzinkt, mit ET-Träger für PVC-Tasche | *gloss-galvanized, with ET carrier for PVC bag* | lustre-galvanisé, avec ET porteur pour le sac de PVC | *lustre-galvanizadi, con ET portador para el bolso del PVC* | zincato lucido, con supporto per borsa in PVC | *glansforzinket, med ET-holdere til PVC-taske*

150 45128 

300 45129 

■i	■■■
150 mm	50 Stck. pcs.
300 mm	50 Stck. pcs.

2: Fachboden

Lower shelf | Étagère | Piano | Estante | Hyldebund

100 45115 

125 45114 

■i
100 x 47 cm
125 x 47 cm

3: Fußsteil

Base | Pied | Piedino | Pie | Fod

45111 

■i
26 x 47 cm

4: Säule

Column | Colonne | Columna | Colonna | Søjle

45110 

■i
6 x 220 x 3 cm



210 x 50 cm



MADE
IN
GERMANY

180 x 60 x 40 cm

Display Rundlochung

Display | Support | Soporte | Espositore | Display

Stahl, 3-seitig, drehbar, für universelle Bestückung, unbestückte Lieferung, passend für HUNTER Lochplattenhaken, mit höhenverstellbaren Füßen | steel, 3-sided, rotatable, for universal mounting, unmounted delivery, suitable for HUNTER perforated plate hooks, with height-adjustable feet | en acier, 3 côtés, tournage, pour un montage universel, livraison à vide, convient aux crochets en tôle perforée HUNTER, avec pieds réglables | acero, 3 lados, rotatorio, para el montaje universal, entrega sin carga, apto para ganchos de chapa perforada HUNTER, con patas ajustables en altura | in acciaio, a 3 lati, ruotabile, per il montaggio universale, consegna a vuoto, adatto per ganci a piastra forata HUNTER, con piedini regolabili in altezza | Stål, 3-sidet, roterbar, til universel samling, uudstyret levering, velegnet til HUNTER perforerede pladekroge, med højdejusterbare fødder

45166

1/4 EURO Lochwanddisplay

1/4 EURO Pegboard Display | 1/4 EURO Présentoir perforé | 1/4 EURO Expositor de pared con orificios | 1/4 EURO Espositore a parete forata | 1/4 EURO Hulvægdisplay

Pappe, für universelle Bestückung, unbestückte Lieferung, passend für HUNTER Lochplattenhaken | cardboard, for universal mounting, unmounted delivery, suitable for HUNTER perforated plate hooks | carton, pour un montage universel, livraison à vide, convient aux crochets en tôle perforée HUNTER | cartón, para el montaje universal, entrega sin carga, apto para ganchos de chapa perforada HUNTER | cartone, per il montaggio universale, consegna a vuoto, adatto per ganci a piastra forata HUNTER | Pap, til universel samling, uudstyret levering, velegnet til HUNTER perforerede pladekroge

45551

**Für Ihre Saisonartikel,
Produktneuheiten
oder selbst definierten
Highlights!**

*For your seasonal articles,
new products
or highlights selected
by you!*

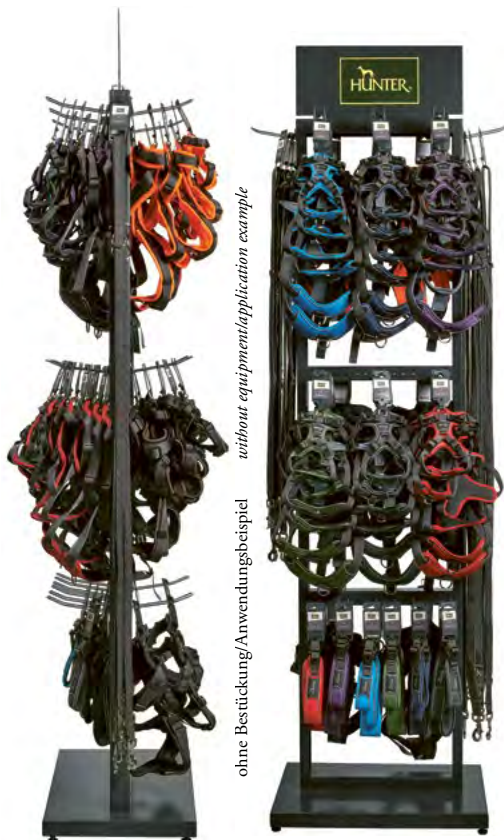

ohne Bestückung/Anwendungsbeispiel
without equipment/application example

H-Display Ständer

H-display stand | Support d'écran H | Expositor en H | Supporto monitor H | H-display stander

Stahl, mit Topper (auswechselbar), für universelle Bestückung, unbestückte Lieferung, passend für HUNTER Lochplattenhaken, mit höhenverstellbaren Füßen, zwei verstellbare Mittelstege | *steel, with topper (exchangeable), for universal mounting, unmounted delivery, suitable for HUNTER perforated plate hooks, with height-adjustable feet, two adjustable centre bars* | en acier, avec topper (échangeable), pour un montage universel, livraison à vide, convient aux crochets en tôle perforée HUNTER, avec pieds réglables, deux barres centrales réglables | *acero, con topper (intercambiable), para el montaje universal, entrega sin carga, apto para ganchos de chapa perforada HUNTER, con patas ajustables en altura, dos barras centrales ajustables* | in acciaio, con topper (intercambiabile), per il montaggio universale, consegna a vuoto, adatto per ganci a piastra forata HUNTER, con piedini regolabili in altezza, due barre centrali regolabili | *Stål, med topper (udskiftelig), til universel samling, udstyret levering, velegnet til HUNTER perforerede pladekroge, med højdejusterbare fødder, to justerbare midterstænger*

68483 

Präsentieren Sie Saisonartikel, Produktneuheiten oder Ihre selbst definierten Highlights aus dem HUNTER-Sortiment übersichtlich und ansprechend auf dem universell einsetzbaren H-Display Ständer. Das geradlinig designte Display kann rundum mit Ware bestückt werden und ist dank zweier höhenverstellbarer Mittelstege flexibel nutzbar. Unebenheiten des Untergrunds lassen sich über vier höhenverstellbare Füße ausgleichen, sodass das Display mitsamt den HUNTER-Artikeln stabil steht. Der Topper mit HUNTER-Logo kann bei Bedarf abgenommen werden.

Ensure clear, attractive presentation of seasonal articles, new products or highlights selected by you from the HUNTER range on the universal H-display stand. Sporting a linear design, the display can be completely filled with items, while its two height-adjustable centre bars make it highly versatile. An uneven base can be balanced out by means of four height-adjustable feet, ensuring the display remains stable complete with the HUNTER items mounted on it. The topper with HUNTER logo can be removed if necessary.

 205 x 55 x 40 cm



Geschirr-Center

Harness Center

Die Auswahl bei hochwertigen Hundegeschirren ist so vielfältig wie deren Einsatzmöglichkeiten und Ausstattungsvarianten. Im HUNTER-Sortiment finden Hundehalter für unterschiedlichste Körperstaturen, Materialvorlieben und Einsatzzwecke das passende »Outfit« für den eigenen Vierbeiner. Manchmal stellt die Suche nach dem individuellen »Lieblings-Geschirr« eine echte Herausforderung dar. Form, Sitz und Materialien sollten auf ganzer Linie überzeugen und die individuellen Bedürfnisse und Ansprüche erfüllen. Das HUNTER Geschirr-Center bietet Orientierung und Kaufberatung in einem. Die Entscheidungsfindung wird angenehm erleichtert und die Kundenzufriedenheit gesteigert. Mit den im stabilen Aluminiumrahmen integrierten Maßbändern kann der Vierbeiner exakt vermessen werden und anhand der übersichtlich gestalteten Größentabelle in der Mitte des Geschirr-Centers ist das »Traum-Geschirr« in der passenden Größe schnell gefunden. Überzeugt es auch bei der obligatorischen Anprobe, sind Hund und Halter glücklich. Worauf darüber hinaus beim Geschirrkau zu achten ist, wird leicht verständlich per Video über den mitgelieferten HD-LED-Monitor (nur Großes Set / Rahmenset 2!) erläutert.

The range of high-quality dog harnesses is as diverse as their possible uses and features. In the HUNTER assortment dog owners can find the suitable »outfit« for their quadruped for most different body shapes, material preferences and purposes. Sometimes the search for the individual »favorite harness« is a real challenge. Shape, fit and materials should be convincing all along the line and meet individual needs and demands. The HUNTER harness center offers orientation and purchase advice in one. Decision making is pleasantly simplified and customer satisfaction is increased. With the measuring tapes integrated in the sturdy aluminum frame, the four-legged friend can be measured exactly and, with the help of the clearly arranged size chart in the heart of the harness center, the »dream harness« in the right size is quickly found. If it convinces also during the obligatory fitting, dog and owner are happy. What else you need to pay attention to when buying a harness is explained in an easy to understand video on the HD-LED monitor (only Large Set / Frame Set 2!).

Vorteile auf einen Blick

Advantages at a glance



Sie erhalten das Komplettsset Ihrer Wahl
You receive the complete set of your choice



Schneller und einfacher Aufbau
Quick and easy assembly



Ein echtes Highlight für Ihren POS
A real highlight for your POS



Pflege der magnetischen Geschirr-Karten und weiterer Komponenten durch Ihren zuständigen Außendienst-Mitarbeiter bzw. Ihre zuständige Außendienst-Mitarbeiterin
Maintenance of the magnetic harness cards and other components by your responsible sales representative



Weckt die Aufmerksamkeit Ihrer Kunden
Attracting the attention of your customers



Weniger fachkundige Beratung erforderlich – die Kunden informieren sich selbst im Detail und treffen eine den Bedürfnissen entsprechende Kaufentscheidung
Less expert advice required - customers inform themselves in detail and make a purchase decision according to their needs



Hohe Informationsdichte & Übersichtlichkeit gleichermaßen
High information density & clarity at the same time



Wenig Aufwand - große Wirkung

Little effort - great effect

Das HUNTER Geschirr-Center bietet Orientierung und Kaufberatung in einem. Die Entscheidungsfindung wird angenehm erleichtert und die Kundenzufriedenheit gesteigert.

The HUNTER harness center offers orientation and purchase advice in one. Decision making is pleasantly simplified and customer satisfaction is increased.

Geschirr-Center SET I

Harness-Center

1,25 m 68771 

Aluminium, umlaufende LED-Beleuchtung, individuelle Bestückung in vier Geschirrkategorien möglich, 19 Haken, Pendeltaschen-Einleger für vier Geschirrkategorien, magnetische Geschirr-Karten zur flexiblen Anbringung am Rahmen, 2 Haken mit 2 Polyester-Maßbändern, Größentabelle mit QR-Code für mehr Informationen, Steckdosenleiste für Beleuchtung, kompatibel mit allen gängigen Lochwandsystemen, schneller und einfacher Aufbau, weiteres Zubehör kann optional ergänzt werden.

Aluminium, all-round LED lighting, individual assembly possible in four harness categories, 19 hooks, pendulum pocket insert for four harness categories, magnetic harness cards for flexible attachment to the frame, 2 hooks with 2 polyester measuring tapes, size chart with QR code for more information, socket strip for lighting, compatible with all common perforated wall systems, quick and easy assembly, further accessories can be added as an option



Geschirr-Center SET 2

Harness-Center

2,50 m 68770 

Aluminium, umlaufende LED-Beleuchtung, 15 Zoll HD-LED-Monitor (16:9) inkl. Fernbedienung, SD-Karte mit hochwertigem Content in Autoloop-Schaltung, individuelle Bestückung in vier Geschirrkategorien möglich, 38 Haken, Pendeltaschen-Einleger für vier Geschirrkategorien, magnetische Geschirr-Karten zur flexiblen Anbringung am Rahmen, 2 Haken mit 2 Polyester-Maßbändern, Größentabelle mit QR-Code für mehr Informationen, Steckdosenleiste für Beleuchtung und LED-Monitor, kompatibel mit allen gängigen Lochwandsystemen, schneller und einfacher Aufbau, weiteres Zubehör kann optional ergänzt werden.

Aluminium, all-round LED lighting, 15 inch HD LED monitor (16:9) incl. remote control, SD card with high-quality content in autoloop circuit, individual assembly possible in four harness categories, 38 hooks, pendulum pocket insert for four harness categories, magnetic harness cards for flexible attachment to the frame, 2 hooks with 2 polyester measuring tapes, size chart with QR code for more information, socket strip for lighting and LED monitor, compatible with all common perforated wall systems, quick and easy assembly, further accessories can be added optionally

small set

Kleines Set

1

1 x 1,25 m

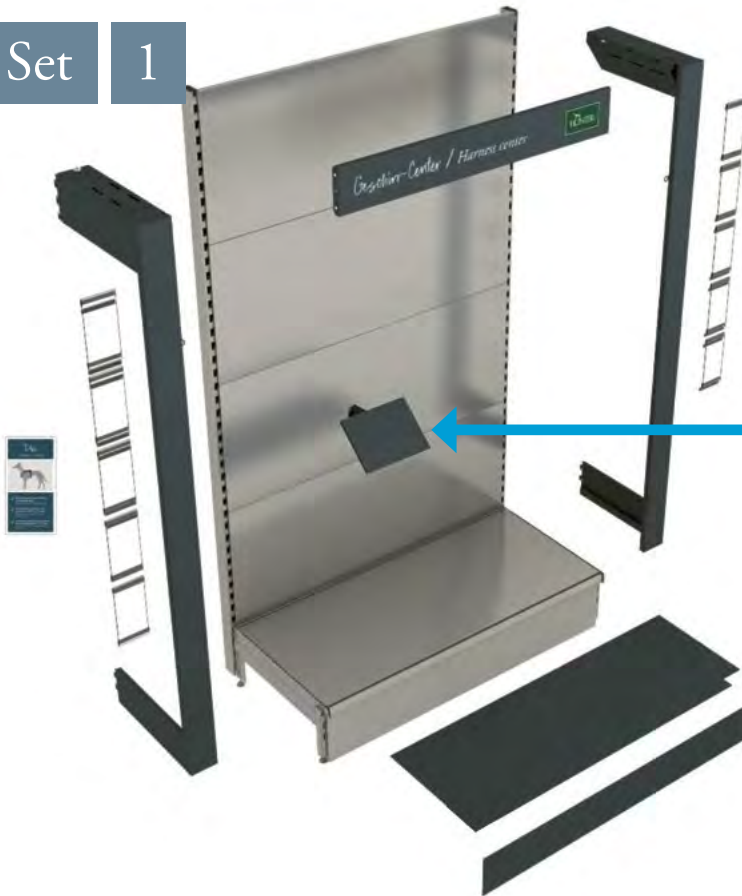

Größentabelle mit QR-Code für mehr Informationen
size chart with QR code for more information

schneller und einfacher Aufbau
quick and easy assembly



Geschirr-Karten zur flexiblen Anbringung am Rahmen
harness cards for flexible attachment to the frame

large set

Großes Set

2

2 x 1,25 m

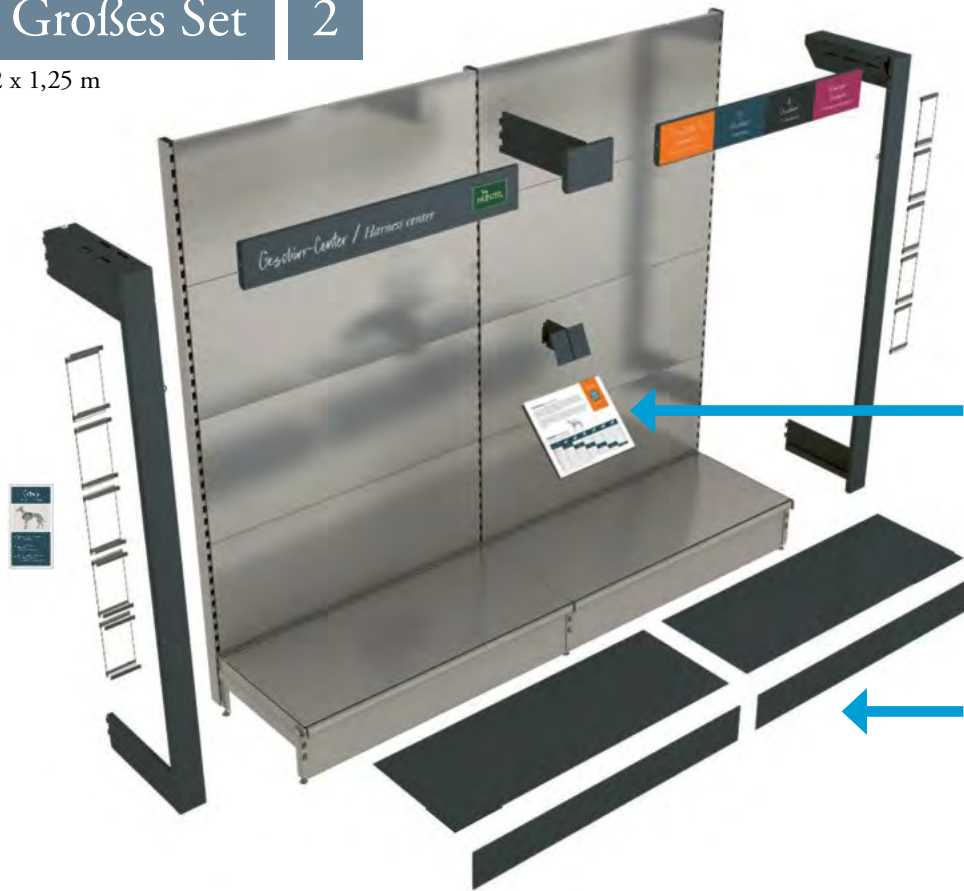

Größentabelle mit QR-Code für mehr Informationen
size chart with QR code for more information

schneller und einfacher Aufbau
quick and easy assembly



Geschirr-Karten zur flexiblen Anbringung am Rahmen
harness cards for flexible attachment to the frame

HD-LED-Monitor
 (16:9) inkl. Fernbedienung
HD LED monitor (16:9) incl. remote control



HUNTER *Shop-in-Shop-System*

Unsere Produkte entstehen mit dem höchsten Anspruch an Materialien, Fertigungsart und Produktkenntnis. Diese Wertschätzung spiegelt sich im Sortiment von HUNTER wieder – und mit diesem Anspruch möchten wir – gemeinsam mit Ihnen – unsere Waren dem Kunden präsentieren.

Das HUNTER Shop-System bietet ein ansprechendes und hochwertiges Umfeld, das dem Endkunden die Möglichkeit gibt, das gesamte HUNTER-Sortiment kompakt vorzufinden. Die besondere Wohlfühl-Atmosphäre erleichtert die Kaufentscheidung. Gerne informieren wir Sie persönlich über die Möglichkeiten und Flexibilität unseres neuen Shop-Systems und stellen verschiedene Konzepte vor. Lassen Sie sich überzeugen. Vielleicht gibt es ja schon bald einen HUNTER Shop-in-Shop bei Ihnen! Kontaktieren Sie uns jederzeit, wir erstellen Ihnen gern ein individuelles, auf Ihre Bedürfnisse abgestimmtes Konzept.

Our products are made with the highest standards of materials, production methods and product knowledge. This high regard is reflected in HUNTER's product range – and with this philosophy in mind – together with you – we would like to present our goods to customers.

The HUNTER shop systems offer an appealing and high-quality environment, which gives end customers the possibility to discover the entire HUNTER product range in compact form. The special feel-good atmosphere facilitates the decision to buy. We will gladly inform you personally about the possibilities and flexibility of our new shop system and introduce various concepts. Why not see for yourself? Maybe there will be a HUNTER shop-in-shop near you soon! Contact us at any time, and we will be happy to create a concept that is individually coordinated to your requirements.

Rückwandmodule

— *Back panel modules* —

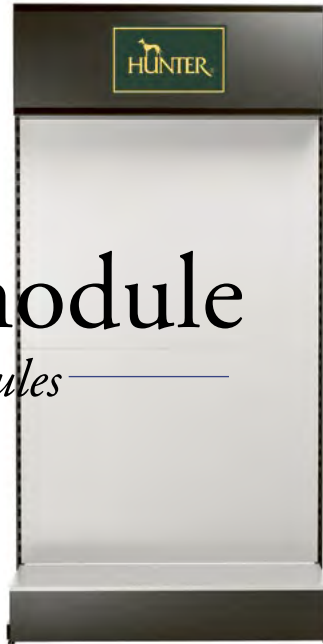

Rückwandmodul Blanko
Back panel module Blanco



Rückwandmodul Lochwand
Back panel module perforated wall



Rückwandmodul Regalböden
Back panel module shelves



Rückwandmodul Traversen
Back panel module goods beam



Rückwandmodul Glasschütten
Back panel module glass shelf



Rückwandmodul Glasschütten
Back panel module glass shelf



Rückwandmodul Mantelstange
Back panel module coat rod



Mittelmöbel

— Centre furnishings —



Auf Sortimente speziell angepasste Möbel und Präsentationsformen. Ermöglicht die Präsentation verschiedener Artikel aus jeder Warengruppe.

Furniture and presentation forms specially adapted to the product ranges. Facilitates the presentation of various articles from every product group.



Das HUNTER Shop-System auf einen Blick:

- Idealbestückung auf Basis jahrelanger Erfahrungswerte
- Individualität in der Sortimentsgestaltung
- Must-Have Produkte werden berücksichtigt
- Priorisierung bei Neuheiten und Aktionen
- Intensive Produktschulungen im Hause HUNTER
- Hohe Kompetenz in den Warengruppen
- Abhebung von Mitbewerbern
- Idealer Warenbestand durch optimale Bestückung
- Attraktive Gestaltung der Fläche

The HUNTER shop system at a glance:

- *Ideal stocking based on many -years of experience*
- *Individually designed product ranges*
- *Must-have products are incorporated*
- *Prioritisation for news and campaigns*
- *Intensive product training at the HUNTER site*
- *High product-group expertise*
- *Standing out against competitors*
- *Ideal inventory by means of optimum stocking*
- *Attractive design of the shop space*



SACHREGISTER

1/4 EURO Lochwanddisplay 530
 zini Clicker mit Umhängeband 230

A

Aalborg **81-95**
 Aalborg Alu-Strong 84
 Aalborg Extrabreit 83
 Aalborg Hearts 85
 Aalborg Mixed 89
 Aalborg Soul 86
 Aalborg Special 82
 Aalborg Style 85
 Aarhus 378, 385
 Adresshülle 239
 Ajka 412
 Albury 234, 235
Allgemeine Geschäftsbedingungen **568**
Alu-Strong
 52, 53, 56, 84, 96, 105, 108, 110, 189, 196, 246
 Alva 222, 223
Amalfi **105-107**
 Amalfi Alu-Strong 105
 Anhänger Hundemarken-Etui . . . 29, 100, 244, 245
 Anti-Schlingnapf 381
 Antijuckreiz-Spray 411
 Aqua Mindelo 283
 Arizona Up 60
 Astana 492
 Atlanta 381
 Ausbildungsgeschirr 232
 Autositz und Reisebett 262

B

Barcelona 274
 Barona 502
 Barrit Alu-Strong 96, 246
 Barry 300
 Basic 103, 383
 Basis Pflegeshampoo 410
 Bayern München, FC . . . 176, 177, 218, 219, 378, 388
 Belbo 504
 Belem 303
 Belluno 490, 491
 Billund 288
 Biri 378, 385
 Birka 304, 422
 Bombs 509
 Boston 467
 Braga 377
 Bugrino 220, 221
 Bugrino Basic 220
 Bugrino Profi 221
 Bugrino Standard 220

Burgos 378
 BVB 174, 175, 218, 219, 379, 388,

C

Calcium Milk Bone 398
Canadian Up **36-41**
 Cannes 56, 57
 Cannes Alu-Strong 56
 Canvas 299
 Canvas Sansibar Rantum 298
 Casper 447
 Catnip Spray 512
 Charlotte 243
 Chester 378, 385
 Cleveland 309, 466
 Clicker mit Umhängeband und Fingerschleife . . . 230
 Clicker mit Universalarmband 230
 Clipstrip 526
 Comfort 67
Convenience **132-137**
 Convenience Comfort 133
 Convenience Reflect 136
 Convenience Reflect Glow 137
 Crossbody-Tasche 243
 Crossbody-Tasche inkl. Decke 265
 Cusio 502

D

Designkarabiner 239
 Diamond Petit 59
 Dimaro 90
 Display Rundlochung 530
 Display Zeckenhaken 412
Divo **152-161**
 Divo Camouflage 152
 Divo Reflect 160-161
 Divo Up 154-157
 Doppeltonpfeife 231
 Dreamie 499
 Dreieckstuch 417
 Dressurhalsung 36, 58, 69, 116
 Dummy 226, 227, 229, 278, 279, 334

E

Easy Change 239
 Ecco Sport 202, 203
 Ecco Sport Vario Basic 202
 Ecco Sport Vario Rapid 202
 Edelstahl 382
 Edelstahlnapf 382
 Eiby 116-120, 289, 375, 388, 468
 El Paso 71
 Entfilzungsmesser 405
 Entwirrungsstriegel, selbstreinigend 407
 Entwirrungsstriegel, zweireihig 407

Ersatznapf für Melamin-Näpfe 381
 Erziehungshilfe 227
 Extra Long 193

F

Fahrrad- & Joggingleine 217
 Faltbare Hundebox 258
 Faltbare Hundebox mit Aluminium-Gestell . . . 259
 Faro 304
 Feldleine 216
 Fellpflege Spray 411
 Feuchtigkeitsshampoo 410
 Filzring 509
 Finja 424
Flingerz™ **310-313**
 Flingerz™ Ball 311
 Flingerz™ Funki 312
 Flingerz™ Furry 312
 Flingerz™ Splash 313
 Floh- und Nissenkamm 404
 Florenz 287
 Flutgasche & Rucksack 266
 Follow me 232
Freestyle **116-121**
 Freestyle Extra Long 118
 Führschleufe 65, 75, 193
 Fully 449
 Futternapf 382
 Fyn 290

G

Gent Antibakteriell 472, 473
 Geschirr-Center 534
 Granby 301
 Gürteltasche 109, 220, 221, 222, 224, 225

H

H-Display Ständer 531
 Hakenleiste zur Produktpräsentation . . . 168, 524
 Halsband-Fliege 247
 Halsung mit Kette 86
 Halter für Apple AirTag 101, 246
 Hamilton 254, 255, 450, 451
 Hecht 510
Hilo **57, 162-177, 219, 240**
 Hilo Basic BVB 175, 219
 Hilo Basic FC Bayern München 177, 219
 Hilo BVB 175
 Hilo Comfort 166, 174, 176
 Hilo Comfort BVB 174
 Hilo Comfort FC Bayern München 176
 Hilo Vario Basic 162
 Hilo Vario Plus 163
 Huggly 301
 Huka 427

 Hunde-Bademantel	418, 419	KONG® Classic	315	KONG® Puppy Goodie Bone™	325
Hunde-Regenmantel	428	KONG® Classic with Rope	316	KONG® Puppy Goodie Bone™ with Rope	325
Hunde-Reisedecke	252, 264, 462	KONG® Comfort HedgeHug™ Puppy	365	KONG® Puppy Tires	324
Hundebar	383	KONG® Comfort Jumbo™ Birds	365	KONG® Quest Star Pods	336
Hundekorpus zur Bekleidungspräsentation	523	KONG® Comfort Pups	364	KONG® Rewards	337
Hundekorbeutel kompostierbar	240	KONG® Comfort™ Kiddos	364	KONG® Rewards Tennis	338
Hundeschal	416	KONG® Connects Peacock	515	KONG® Rewards Tinker	342
Hunting	52-54	KONG® CoreStrength™ Ball	332	KONG® Rewards Wally®	339
Hunting Alu-Strong	52	KONG® CoreStrength™ Bamboo Bone	336	KONG® Ring	316
		KONG® Cozie™	362	KONG® Rope Ball Puppy	330
I		KONG® Cozie™ Naturals	362	KONG® Rope Bunji	329
Inari	196, 280, 474	KONG® Cozie™ Tuggz Cheetah	362	KONG® Rope Tug Puppy	330
Inari Alu-Strong	196	KONG® Crackles Grasshopper	516	KONG® Safestix	334
		KONG® CrunchAir™ Balls	350	KONG® Scrunch Knots Fox	369
J		KONG® Cuteseas Rufflez	355	KONG® Shakers Cuckoos	359
Jamuna	281	KONG® CuteSeas™ Octopus	355	KONG® Shakers Shimmy™	358
Jena	281	KONG® Dental Stick™	319	KONG® Shakers™ Crumples	358
Jula	231	KONG® Dental with Rope	319	KONG® Shakers™ Honkers	359
		KONG® Dotz™ Circle	336	KONG® Shakers™ Luvs	359
K		KONG® Dragon Knots	366	KONG® Sherps™	356
Kangaroo	268	KONG® DuraMax™ Ball	332	KONG® Sherps™ Floofs	356
Kansas	271	KONG® Easy Treat™	345	KONG® Shields Tropics	360
Katalog Vol. XII	521	KONG® Extreme	320	KONG® Signature Ball	327
Katzenbett	499-502	KONG® Extreme Ball	321	KONG® Signature Crunch Rope Single	328
Katzennapf	502-505	KONG® Extreme Ball with Rope	322	KONG® Signature Rope Double Ring Tug	329
Katzenoilette	506, 507	KONG® Extreme Dental	322	KONG® Signature Rope Dual Knot	329
Keramik-Katzennapf	504, 505	KONG® Extreme Dental with Rope	322	KONG® Signature Sport Balls	349
Keramik-Napf	371-377, 504, 507	KONG® Extreme Flyer	323	KONG® Signature Stick	328
Kettenführleine	65	KONG® Extreme Goodie Bone™	320	KONG® Signature Stick with rope	328
Kington	378, 385	KONG® Extreme Goodie Ribbon™	320	KONG® Snacks™	344
Kisa	283	KONG® Extreme Ring	321	KONG® Sneakerz Knots	369
Knoten	282	KONG® Extreme Tyres	323	KONG® Snugga Wubba™	352
Kofferraum-Schutzdecke	254, 450	KONG® Flexball	326	KONG® Snuzzles	357
Kolding	300	KONG® Floppy Knots	366	KONG® Sport Balls	350
Koloa	308	KONG® Flyangle™	333	KONG® Squeakair® Ball with Rope	346
Kombibürste »Bürsten und Pflegen«	406	KONG® Flyer	317	KONG® Squeakair® Balls	346
Kombibürste »Zupfen und Kämmen«	406	KONG® Goodie Bone™	318	KONG® Squeakair® Birthday Balls	349
Kombileine 6in1	75	KONG® Gyro	337	KONG® Squeakair® Ultra Balls	350
KONG®	314-369, 512-519	KONG® Jaxx Brights	333	KONG® Squeezz® Action	327
KONG® Active Bubble Ball	515	KONG® Jumbler™	326	KONG® Squeezz® Ball	327
KONG® AirDog® Squeaker Bone	347	KONG® Knots Carnival	363	KONG® Squeezz® Crackle	334
KONG® AirDog® Squeaker Dumbbell	347	KONG® Knots Twists	367	KONG® Squeezz® Dental Stick	335
KONG® AirDog® Squeaker Fetch Stick	347	KONG® Licks Rewards	341	KONG® Squeezz® Stick	335
KONG® AirDog® Squeaker Football	346	KONG® Licks Spinz	340	KONG® Squeezz® Goomz	332
KONG® AirDog® Squeaker Knobby Ball	348	KONG® Maxx	331	KONG® Stretchezz™ Jumbo	363
KONG® AirDog® Squeaker Paw	348	KONG® Naturals	512	KONG® Stuff'N™ Peanut butter	345
KONG® Aqua	316	KONG® Ogee™ Stick	333	KONG® Switcheroos	357
KONG® Ball	318	KONG® Phatz™	354	KONG® Teaser Jellyfish	518
KONG® Ballistic® VibeZ Birds	354	KONG® Play Spaces Cloud	519	KONG® Teaser Loopz	518
KONG® Bamboo Feeder	338	KONG® Pull-A-Partz™ Pinata	517	KONG® TennisShoes	355
KONG® Biscuit Ball™	319	KONG® Pull-A-Partz™ Sushi	516	KONG® Tigr	339
KONG® Bounzer™	317	KONG® Pull-A-Partz™ Yarnz	517	KONG® Training Dummy	334
KONG® Brush	315	KONG® Puppy	324	KONG® Treat Spinner	342
KONG® Cat Puzzlements™ Pie	513	KONG® Puppy Binkie™	324	KONG® Treat Spiral Stick	335
KONG® Catnip Infuser	513	KONG® Puppy Flyer	325	KONG® Tropics	519

-  KONG® Tug Toy 318
 KONG® Tugger Knots® 369
 KONG® Tuggz™ 361
 KONG® Twistz 326
 KONG® Wild Knots 366
 KONG® Wild Knots Bears 367
 KONG® WildShieldz 360
 KONG® Wobbler™ 317
 KONG® Woozles 361
 KONG® Wrangler Angler Fish 514
 KONG® Wrangler Cactus 514
 KONG® Wubba™ Ballistic Friends 353
 KONG® Wubba™ Classic 351
 KONG® Wubba™ Finz 353
 KONG® Wubba™ Floppy Ears 352
 KONG® Wubba™ Friends 352
 KONG® Wubba™ Puppy 351
 KONG® Wubba™ Weaves 353
 KONG® Wubba™ Wet 351
 KONG® Wubba™ Octopus 354
 KONG® Zoomgroom™ 408
 Konstanz 449
 Koppel 75, 193
 Kotbeutelspender 27, 96, 172, 240, 241, 242
 Krallenschere 405
 Krallenzange 405
 Kratzbaum 496
 Kratzturm 498
 Kumara 484, 485
 Kunststoff Maulkorb 233
 Kurzführer 74, 75, 214
 Kwallé Karl 510
- L**
 Lachs-Öl für Hunde 400, 401
 Lachs-Öl für Katzen 400, 401
 Lancaster 469-471
 Langa 505
 Larvik 64-65
 Leckerchen-Spender 340
 Leinenhalter 96, 246
Lemvig 98, 99
 Lifestyle 394
 Lisboa 377
 List 250-251
 Livingston 476, 478
London 204-211
 London Comfort 208
 London Vario Basic 204
 London Vario Plus 205
 London Vario Rapid 206
 Loppa 454
 Los Angeles 275
Love 24-29, 242, 244
 Lugano 453
- Lugo 218
 Lund 371
 Luton 378, 385
- M**
 Madison 272, 273
 Madona 61
 Madrid 297
 Magic Star 23
 Magnet-Banner 527
 Magnet-Folie 522
Maldon 140-151
 Maldon Up 146
Malia 122-129
 Malmö 416, 423
 Malta 102
 Mantelstange 522
 Marienkäferbürste 256, 409
 Marle 291
 Maulkorb 233, 234, 235
 Maxis 393
 Mayfair 378, 385
Melamin-Napf 378-381, 502
 Merida 480-482
 Miles 266
Milford 430
 Mini Calcium Milk Bone 398
 Miniball 509
 Miranda 453
 Modica 61
 Mogami 378
 Moss 236, 237
 Mousi Long 511
 Muli 303
 München 42-45
 München Mini 42
- N**
 Namy 382
 Napfunterlage 384-388
 Nappa Petit 59
 Nebraska 295
 Neopren 178-185
 Neopren Reflect 181
 Neopren Reflect BVB 174
 Neopren Reflect FC Bayern München 176
 Neopren Vario Plus 180
 Neopren Vario Quick 184
 Nola 417
 Nora 486, 487
Nordby 432-434
 Nordby Dachshund 432
 Nordby Mops & Co. 432
 Norwegeschirr 53, 192
- O**
 Octi Otto 511
 Odense 421
 Oligo 507
 Orlando 270
 Orthopädische Hundematte 479
 Orthopädisches Hundekissen 482
 Orthopädisches Hundesofa 456, 464, 465, 466, 478, 480, 481, 483
 Osby 372
 Osby Glazed 373
 Outdoor Trinkflasche mit Silikonnapf 251
 Ovada 505
 Owen 496, 497
- P**
 Palettenhülle 521
 Panikgeschirr 148, 191
 Paris 247
Paxson 435-437
 Paxson Dachshund 436
 Paxson Mops & Co. 436
 Peppermint Snack 397
 Pflegebürste 406
 Pflegebürste Extra Soft 406
 Pflegebürste, selbstreinigend 406
 Pflegehandschuh 407
 Pflegekamm mit langen und kurzen Zinken 404
 Pflegekamm mit rotierenden Zinken 404
 Pflegemesser 405
 Pflegeshampoo 410
 Pflegestriegel mit integr. Shampoofunktion 407
 Pfotenpflege 411
 Polster-Schondecke 460
 Pori 302
 Portland 270
 Porto 50, 51
- R**
 Racing 192
 Rambo 63
 Ranger 192
 Real 392
 Real Sticks 392
 Reinigungsbürste 315
 Reisenapf 249, 389
 Retriever-Führleine 119
 Retriever-Leine 39, 74, 120
 Ribe 475
 Riga 418, 419
 Rimini 499
 Rio 296
 Road Refresher™ 249, 389
Rockford 252, 456-463
 Rolli 508

-  Round & Soft 36-39, 54, 58
 Rückbank-Schutzdecke 254, 450
 Ruckdämpfer 217
 Rucksack 266, 268, 269, 270
 Rucksack/Tragetasche 269
- S**
- Salima 298
 Samara 453
Sansibar 78, 79, 130, 218, 294, 298
 Sansibar Kampen 294
 Sansibar Morsum 218
 Sansibar Rantum 130
 Sansibar Solid 78
 Schlüsselanhänger 29, 244
 Schmutzfang-Hundematte 448
 Schwimmweste 236, 237
 Seattle 464, 465
 Seaweed Bones 399
 Selection 386
 Selection faltbar 384
 Selection rund 384
Seoul 260-265
 Shampoo für schwarzes Fell 410
 Shampoo für weißes Fell 410
 Shopper Bag HUNTER 526
 Sicherheitsgeschirr 148, 191
 Silda 378
 Silikon falt-Reisenapf 251
 Silikon Reisenapf 250
 Silikon Reisenapf mit Tasche 250
 Siljan 506
 Sioux 61
 Skagen 293
 Snackbeutel . 109, 173, 175, 177, 218, 219, 220, 221,
 222, 224, 225
 Snaky 508
 Snugly 305
Sofia 108, 109
 Sofia Alu-Strong 108
Softie 110-113
 Softie Alu-Strong 110
 Softie Deluxe 111
 Softie Stone 111
 Softie Triluxe 111
Soho Mini 46-49
Soho X Love 48
Solid Education 69-77
 Solid Education Cord 77
 Solid Education Duo 76
 Solid Education Exclusive 71
 Solid Education Special 70
Spa 404-407, 410, 411
 Spike Ball 282
 Spike Bone 397
 Steppbett 469
- Striegel für Hunde 408
stylecats® 494-511
 Suchleine 74, 135, 211, 213, 214, 215, 216
 Super Soft 63
Swiss 21, 22
- T**
- Tanaro 504
 Tara 55
 Tasty Tooth Bone 397
 Taylor 269
 Teckel-Halsband 43
 Terni 302
 Tijuana 63
 Tirana 293
 Tirano 479
 Tough Kamerun 285
 Tough Monster 294
 Tough Pombas 226, 277, 278
 Tough Toys 285
 Tough Tundra 284
 Tragebeutel 275
 Trainer Disc 227
 Training 395, 396
 Trainingshalsband mit Griff 64
 Traverse für Warenträgersystem 529
 Trient 227, 279
 Trimmmesser, sichelförmig 405
 Trimmstriegel mit Edelstahlklinge 407
 Trimmstriegel Spezialklinge 407
 Trino 131
 Tripoli 198-201
 Tripoli Vario Basic 198
 Trosa 483
 Tumba 498
 Tyra 224, 225
- U**
- Umhänge-Snackbeutel 222
 University 493
Uppsala 428, 438-445
 Uppsala Allrounder 443
 Uppsala Cozy 442
 Uppsala Rain 428
 Uppsala Softshell 438
 Uppsala Trend 444
- V**
- Valencia 378
 Vara 502
 Varde 96, 242
 Vario Basic 162, 187, 189, 198, 202, 204
 Vario Basic Alu-Strong 189
 Vario Plus 163, 180, 188, 205
 Vario Rapid 190, 191, 202, 206
 Vario-Leine 121
- Venice 307
 Vermont 452
 Vermont Cozy 452
 Viborg 101, 246
 Visby Super Grip 214
 Vorführleine 213
- W**
- Warenträgersystem 529
 Warnband mit Klettverschluss 231
 Warnweste für Hunde 231
 Wasserspielzeug
 277, 283, 311, 313, 316, 326, 333, 334, 347, 351, 360
 Waterloo 448
 Wellness Handschuh 408
 Wellness Massage Striegel 408
 Welpenshampoo 410
 Wildlife 305
 Windhundhalsband 27, 63
- Y**
- Yuna 241
- Z**
- Zeckenhaken 412
 Zupfbürste, selbstreinigend 406

GLOSSARY

1/4 EURO Pegboard Display 530
2-in-1 clicker with lanyard 230

A

Aalborg **81-95**
Aalborg Alu-Strong 84
Aalborg Extrabreit 83
Aalborg Hearts 85
Aalborg Mixed 89
Aalborg Soul 86
Aalborg Special 82
Aalborg Style 85
Aarhus 378, 385
Ajka 412
Albury 234, 235
Alu-Strong
52, 53, 56, 84, 96, 105, 108, 110, 189, 196, 246
Alva 222, 223
Amalfi 105-107
Amalfi Alu-Strong 105
Anti-itch Spray 411
Aqua Mindelo 283
Arizona Up 60
Astana 492
Atlanta 381

B

Backpack 266, 268, 269, 270
Backpack/Carry bag 269
Barcelona 274
Barona 502
Barrit Alu-Strong 96, 246
Barry 300
Basic 103, 383
Basic care shampoo 410
Bayern München, FC . . 176, 177, 218, 219, 378, 388
Belbo 504
Belem 303
Belluno 490, 491
Belt bag 109, 220, 221, 222, 224, 225
Bicycle & jogging leash 217
Billund 288
Biri 378, 385
Birka 304, 422
Bombs 509
Boston 467
Braga 377
Brush mat for dogs 448
Bugrino 220, 221
Bugrino Basic 220
Bugrino Profi 221
Bugrino Standard 220
Burgos 378
BVB 174, 175, 218, 219, 379, 388

C

Calcium Milk Bone 398
Canadian Up **36-41**
Cannes 56, 57
Cannes Alu-Strong 56
Canvas 299
Canvas Sansibar Rantum 298
Car blanket for protection for the trunk . . 254, 450
Car dog carrier bag and blanket 262
Care glove 407
Care shampoo 410
Carry bag 275
Casper 447
Cat bed 499-502
Cat bowls 502-505
Cat toilet 506, 507
Catalogue 521
Catnip Spray 512
Ceramic bowl 371-377, 504, 505
Ceramic cat bowl 504, 505
Chain leash 65
Charlotte 243
Chester 378, 385
Cleaning brush 315
Cleveland 309, 466
Clicker universal wristband 230
Clicker with lanyard and finger loop 230
Clipstrip 526
Coat rod 522
Collar bow tie 247
Collar with chain 86
Combi-leash 6in1 75
Comfort 67
Convenience **132-137**
Convenience Comfort 133
Convenience Reflect 136
Convenience Reflect Glow 137
Coupling 75, 193
Crossbar for goods display system 529
Crossbody bag 243
Crossbody bag incl. blanket 265
Curry comb/shampooing function 407
Curry-comb for dogs 408
Cusio 502

D

Dachshund collar 43
Dematting knife 405
Design snap hook 239
Detangling rake, double row 407
Detangling rake, self-cleaning 407
Diamond Petit 59
Dimaro 90
Display 530
Display tick hook 412
Divo **152-161**
Divo Camouflage 152

Divo Reflect 160-161
Divo Up 154-157
Dog bar 383
Dog carcass for clothing presentation 523
Dog scarf 416
Dog Tag Case Pendant 29, 100, 244, 245
Dog waste bag compostable 240
Dreamie 499
Dummy 226, 227, 229, 278, 279, 334

E

Easy Change 239
Ecco Sport 202, 203
Ecco Sport Vario Basic 202
Ecco Sport Vario Rapid 202
Edelstahl 382
Education assistance 227
Education harness 232
Eiby 116-120, 289, 375, 388, 468
El Paso 71
Extra Long 193

F

Faro 304
Feeding bowl 382
Filzring 509
Finja 424
Flea and nit comb 404
Flight Bag & Backpack 266
Flingerz™ **310-313**
Flingerz™ Ball 311
Flingerz™ Funki 312
Flingerz™ Furry 312
Flingerz™ Splash 313
Florenz 287
Foldable dog box 258
Foldable dog box with aluminium frame . . . 259
Follow me 232
Food bowl base 384-388
Freestyle **116-121**
Freestyle Extra Long 118
Fully 449
Fyn 290

G

General Terms and Conditions **568**
Gent Antibakteriell 472, 473
Granby 301
Greyhound collar 27, 63
Grooming brush 406
Grooming brush Extra Soft 406
Grooming brush, self-cleaning 406
Grooming comb/long and short teeth 404
Grooming comb/rotating teeth 404
Grooming knife 405
Grooming spray 411

-  **H**
- H-display stand 531
 - Hamilton 254, 255, 450, 451
 - Harness-Center 534
 - Hecht 510
 - Hilo** **57, 162-177, 219, 240**
 - Hilo Basic BVB 175, 219
 - Hilo Basic FC Bayern München 177, 219
 - Hilo BVB 175
 - Hilo Comfort 166, 174, 176
 - Hilo Comfort BVB 174
 - Hilo Comfort FC Bayern München 176
 - Hilo Vario Basic 162
 - Hilo Vario Plus 163
 - Holder for Apple AirTag 101, 246
 - Hook rail for product presentation 168, 524
 - Huggly 301
 - Huka 427
 - Dog bathrobe 418, 419
 - Hunting 52-54
 - Hunting Alu-Strong 52
- I**
- Identification tube 239
 - Inari 196, 280, 474
 - Inari Alu-Strong 196
- J**
- Jamuna 281
 - Jena 281
 - Jula 231
- K**
- Kangaroo 268
 - Kansas 271
 - Keychain 29, 244
 - Kington 378, 385
 - Kisa 283
 - Knoten 282
 - Kolding 300
 - Koloa 308
 - KONG®** **314-369, 512-519**
 - KONG® Active Bubble Ball 515
 - KONG® AirDog® Squeaker Bone 347
 - KONG® AirDog® Squeaker Dumbbell 347
 - KONG® AirDog® Squeaker Fetch Stick 347
 - KONG® AirDog® Squeaker Football 346
 - KONG® AirDog® Squeaker Knobby Ball 348
 - KONG® AirDog® Squeaker Paw 348
 - KONG® Aqua 316
 - KONG® Ball 318
 - KONG® Ballistic® VibeZ Birds 354
 - KONG® Bamboo Feeder 338
 - KONG® Biscuit Ball™ 319
 - KONG® Bounzer™ 317
 - KONG® Brush 315
 - KONG® Cat Puzzlements™ Pie 513
 - KONG® Catnip Infuser 513
 - KONG® Classic 315
 - KONG® Classic with Rope 316
 - KONG® Comfort HedgeHug™ Puppy 365
 - KONG® Comfort Jumbo™ Birds 365
 - KONG® Comfort Pups 364
 - KONG® Comfort™ Kiddos 364
 - KONG® Connects Peacock 515
 - KONG® CoreStrength™ Ball 332
 - KONG® CoreStrength™ Bamboo Bone 336
 - KONG® Cozie™ 362
 - KONG® Cozie™ Naturals 362
 - KONG® Cozie™ Tuggz Cheetah 362
 - KONG® Crackles Grasshopper 516
 - KONG® CrunchAir™ Balls 350
 - KONG® Cuteseas Rufflez 355
 - KONG® CuteSeas™ Octopus 355
 - KONG® Dental Stick™ 319
 - KONG® Dental with Rope 319
 - KONG® Dotz™ Circle 336
 - KONG® Dragon Knots 366
 - KONG® DuraMax™ Ball 332
 - KONG® Easy Treat™ 345
 - KONG® Extreme 320
 - KONG® Extreme Ball 321
 - KONG® Extreme Ball with Rope 322
 - KONG® Extreme Dental 322
 - KONG® Extreme Dental with Rope 322
 - KONG® Extreme Flyer 323
 - KONG® Extreme Goodie Bone™ 320
 - KONG® Extreme Goodie Ribbon™ 320
 - KONG® Extreme Ring 321
 - KONG® Extreme Tyres 323
 - KONG® Flexball 326
 - KONG® Floppy Knots 366
 - KONG® Flyangle™ 333
 - KONG® Flyer 317
 - KONG® Goodie Bone™ 318
 - KONG® Gyro 337
 - KONG® Jaxx Brights 333
 - KONG® Jumbler™ 326
 - KONG® Knots Carnival 363
 - KONG® Knots Twists 367
 - KONG® Licks Rewards 341
 - KONG® Licks Spinz 340
 - KONG® Maxx 331
 - KONG® Naturals 512
 - KONG® Ogee™ Stick 333
 - KONG® Phatz™ 354
 - KONG® Play Spaces Cloud 519
 - KONG® Pull-A-Partz™ Pinata 517
 - KONG® Pull-A-Partz™ Sushi 516
 - KONG® Pull-A-Partz™ Yarnz 517
 - KONG® Puppy 324
 - KONG® Puppy Binkie™ 324
 - KONG® Puppy Flyer 325
 - KONG® Puppy Goodie Bone™ 325
 - KONG® Puppy Goodie Bone™ with Rope 325
 - KONG® Puppy Tires 324
 - KONG® Quest Star Pods 336
 - KONG® Rewards 337
 - KONG® Rewards Tennis 338
 - KONG® Rewards Tinker 342
 - KONG® Rewards Wally® 339
 - KONG® Ring 316
 - KONG® Rope Ball Puppy 330
 - KONG® Rope Bunji 329
 - KONG® Rope Tug Puppy 330
 - KONG® Safestix 334
 - KONG® Scrunch Knots Fox 369
 - KONG® Shakers Cuckoos 359
 - KONG® Shakers Shimmy™ 358
 - KONG® Shakers™ Crumples 358
 - KONG® Shakers™ Honkers 359
 - KONG® Shakers™ Luvs 359
 - KONG® Sherps™ 356
 - KONG® Sherps™ Floofs 356
 - KONG® Shields Tropics 360
 - KONG® Signature Ball 327
 - KONG® Signature Crunch Rope Single 328
 - KONG® Signature Rope Double Ring Tug 329
 - KONG® Signature Rope Dual Knot 329
 - KONG® Signature Sport Balls 349
 - KONG® Signature Stick 328
 - KONG® Signature Stick with rope 328
 - KONG® Snacks™ 344
 - KONG® Sneakerz Knots 369
 - KONG® Snugga Wubba™ 352
 - KONG® Snuzzles 357
 - KONG® Sport Balls 350
 - KONG® Squeakair® Ball with Rope 346
 - KONG® Squeakair® Balls 346
 - KONG® Squeakair® Birthday Balls 349
 - KONG® Squeakair® Ultra Balls 350
 - KONG® Squeezz® Action 327
 - KONG® Squeezz® Ball 327
 - KONG® Squeezz® Crackle 334
 - KONG® Squeezz® Dental Stick 335
 - KONG® Squeezz® Stick 335
 - KONG® Squeezz® Goomz 332
 - KONG® Stretchezz™ Jumbo 363
 - KONG® Stuff'N™ Peanut butter 345
 - KONG® Switcheroos 357
 - KONG® Teaser Jellyfish 518
 - KONG® Teaser Loopz 518
 - KONG® TenniShoes 355
 - KONG® Tikr 339
 - KONG® Training Dummy 334



KONG® Treat Spinner 342
 KONG® Treat Spiral Stick 335
 KONG® Tropics 519
 KONG® Tug Toy 318
 KONG® Tugger Knots® 369
 KONG® Tuggz™ 361
 KONG® Twistz 326
 KONG® Wild Knots 366
 KONG® Wild Knots Bears 367
 KONG® WildShieldz 360
 KONG® Wobbler™ 317
 KONG® Woozles 361
 KONG® Wrangler Angler Fish 514
 KONG® Wrangler Cactus 514
 KONG® Wubba™ Ballistic Friends 353
 KONG® Wubba™ Classic 351
 KONG® Wubba™ Finz 353
 KONG® Wubba™ Floppy Ears 352
 KONG® Wubba™ Friends 352
 KONG® Wubba™ Puppy 351
 KONG® Wubba™ Weaves 353
 KONG® Wubba™ Wet 351
 KONG® Wubba™ Octopus 354
 KONG® Zoomgroom™ 408
 Konstanz 449
 Kumara 484, 485
 Kwalle Karl 510

L

Lancaster 469-471
 Langa 505
 Larvik 64-65
 Leash holder 96, 246
Lemvig **98, 99**
 Lifestyle 394
 Lisboa 377
 List 250-251
 Livingston 476, 478
London **204-211**
 London Comfort 208
 London Vario Basic 204
 London Vario Plus 205
 London Vario Rapid 206
 Loppa 454
 Los Angeles 275
Love **24-29, 242, 244**
 Lugano 453
 Lugo 218
 Lund 371
 Luton 378, 385

M

Madison 272, 273
 Madona 61
 Madrid 297
 Magic Star 23

Magnetic banner 527
 Magnetic Foil 522
Maldon **140-151**
 Maldon Up 146
Malia **122-129**
 Malmö 416, 423
 Malta 102
 Marienkäfer 256, 409
 Marle 291
 Maxis 393
 Mayfair 378, 385
Melamine feeding bowl **378-381, 502**
 Merida 480-482
 Miles 266
Milford **430**
 Mini Calcium Milk Bone 398
 Miniball 509
 Miranda 453
 Modica 61
 Mogami 378
 Moisturising Shampoo 410
 Moss 236, 237
 Mousi Long 511
 Muli 303
 Multi-purpose brush »Brushing and grooming« ..
 406
 Multi-purpose brush »Plucking and combing« 406
 München 42-45
 München Mini 42
 Muzzle 233, 234

N

Nail clippers 405
 Nail scissors 405
 Namy 382
 Nappa Petit 59
 Nebraska 295
 Neopren 178-185
 Neopren Reflect 181
 Neopren Reflect BVB 174
 Neopren Reflect FC Bayern München 176
 Neopren Vario Plus 180
 Neopren Vario Quick 184
 Nola 417
 Nora 486, 487
Nordby **432-434**
 Nordby Dachshund 432
 Nordby Mops & Co. 432
 Norwegian harness 53, 192

O

Octi Otto 511
 Odense 421
 Oligo 507
 Orlando 270
 Orthopaedic dog cushion 482

Orthopaedic dog mat 479
 Orthopaedic dog sofa
 456, 464, 465, 466, 478, 480, 481, 483
 Osby 372
 Osby Glazed 373
 Outdoor drinking bottle with silicone bowl .. 251
 Ovada 505
 Owen 496, 467

P

Pallet cover 521
 Panic harness 148, 191
 Paris 247
 Paw care 411
Paxson **435-437**
 Paxson Dachshund 436
 Paxson Mops & Co. 436
 Peppermint Snack 397
 Pillow and dog blanket 2in2 461
 Plastic muzzle 233
 Plucking brush, self-cleaning 406
 Pori 302
 Portland 270
 Porto 50, 51
 Presentation for Tego 529
 Puppy shampoo 410

Q

Quilted dog bed 469

R

Racing 192
 Rain coat for dogs 428
 Rambo 63
 Ranger 192
 Real 392
 Real Sticks 392
 Rear seat cover 254, 450
 Retriever leash 39, 74, 120
 Retriever training leash 119
 Ribe 475
 Riga 418, 419
 Rimini 499
 Rio 296
 Road Refresher™ 249, 389
Rockford **252, 456-463**
 Rolli 508
 Round & Soft 36-39, 54, 58

S

Safety harness with handle 148, 191
 Safety waistcoat for dogs 231
 Salima 298
 Salmon oil for cats 400, 401
 Salmon oil for dogs 400, 401
 Samara 453

-  **Sansibar** 78, 79, 130, 218, 294, 298
- Sansibar Kampen 294
- Sansibar Morsum 218
- Sansibar Rantum 130
- Sansibar Solid 78
- Scratch tower 498
- Scratching post 496
- Seattle 464, 465
- Seaweed Bones 399
- Selection 386
- Selection faltbar 384
- Selection rund 384
- Seoul** 260-265
- Shampoo for black fur 410
- Shampoo for white fur 410
- Shopper Bag HUNTER 526
- Short leash 74, 75, 214
- Show leash 213
- Silda 378
- Silicone fold travel bowl 251
- Silicone travel bowl 250
- Silicone travel bowl with bag 250
- Siljan 506
- Sioux 61
- Skagen 293
- Slow feeding bowl 381
- Snack bag . . . 109, 173, 175, 177, 218, 219, 220, 221, 222, 224, 225
- Snack bag with shoulder strap 222, 223
- Snaky 508
- Snugly 305
- Sofa cover 460
- Sofia** 108, 109
- Sofia Alu-Strong 108
- Softie** 110-113
- Softie Alu-Strong 110
- Softie Deluxe 111
- Softie Stone 111
- Softie Triluxe 111
- Soho Mini** 46-49
- Soho X Love** 48
- Solid Education** 69-77
- Solid Education Cord 77
- Solid Education Duo 76
- Solid Education Exclusive 71
- Solid Education Special 70
- Spa** 404-407, 410, 411
- Spare bowl for melamine bowls 381
- Spike Ball 282
- Spike Bone 397
- Stainless steel bowl 382
- Stripping knife, crescent-shaped 405
- Stripping rake special blade 407
- Stripping rake with stainless steel blade 407
- stylecats®** 494-511
- Super Soft 63
- Swim vest 236, 237
- Swiss** 21, 22
- T**
- Tanaro 504
- Tara 55
- Tasty Tooth Bone 397
- Taylor 269
- Terni 302
- Tick hook 412
- Tijuana 63
- Tirana 293
- Tirano 479
- Tough Kamerun 285
- Tough Monster 294
- Tough Pombas 226, 277, 278
- Tough Toys 285
- Tough Tundra 284
- Tracking leash 216
- Tracking leash 74, 135, 211, 213, 214, 215, 216
- Traffic leash 65, 75, 193
- Trainer Disc 227
- Training 395, 396
- Training collar 36, 58, 69, 116
- Training collar with handle 64
- Travel blanket for dogs 252, 264, 462
- Travel bowl 249, 389
- Treat dispenser 340
- Triangular scarf 417
- Trient 227, 279
- Trino 131
- Tripoli 198-201
- Tripoli Vario Basic 198
- Trosa 483
- Tug absorber 217
- Tumba 498
- Two-tone whistle 231
- Tyra 224, 225
- U**
- University 493
- Uppsala** 428, 438-445
- Uppsala Allrounder 443
- Uppsala Cozy 442
- Uppsala Rain 428
- Uppsala Softshell 438
- Uppsala Trend 444
- V**
- Valencia 378
- Vara 502
- Varde 96, 242
- Vario Basic 162, 187, 189, 198, 202, 204
- Vario Basic Alu-Strong 189
- Vario leash 121
- Vario Plus 163, 180, 188, 205
- Vario Rapid 190, 191, 202, 206
- Venice 307
- Vermont 452
- Vermont Cozy 452
- Viborg 101, 246
- Visby Super Grip 214
- W**
- Warning reflecting strap with velcro fastener . . 231
- Waste bag dispenser . . . 27, 96, 172, 240, 241, 242
- Water toys 277, 283, 311, 313, 316, 326, 333, 334, 347, 351, 360
- Waterloo 448
- Wellness glove 408
- Wellness massage curry comb 408
- Wildlife 305
- Y**
- Yuna 241

Ihr HUNTER Team vor Ort

Your HUNTER team

Es macht Spaß, Teil dieses facettenreichen Teams zu sein, Tag für Tag eigene Ideen einbringen zu können und die Liebe zu HUNTER weltweit zu verbreiten. Leidenschaftlich sind wir, mit Herzblut bei der Sache und »immer wieder anders«. Innovation hat bei HUNTER Tradition und unser Ziel ist es, das Leben mit den geliebten Vierbeinern so angenehm und komfortabel wie möglich zu gestalten. Kostbare Qualitätszeit für die, die wir lieben. Rund 170 Mitarbeiterinnen und Mitarbeiter geben Tag für Tag in der Manufaktur, im Customer Service, im Produktmanagement, im Marketing und den vielen weiteren Bereichen in der HUNTER Gruppe ihr Bestes, um die Marke HUNTER im besten Licht strahlen zu lassen. Wir alle, komplettiert um unsere geliebten Bürohunde, wir sind die HUNTER Familie. Lernen Sie einen Teil von uns auf den folgenden Seiten kennen...

It's a pleasure to be part of this multifaceted team, to be able to contribute ones own ideas day after day and to spread the love for HUNTER worldwide. We are passionate, put our heart and soul into our work and are »always different«. Innovation is a tradition at HUNTER and our goal is to make life with our beloved four-legged friends as pleasant and comfortable as possible. Precious quality time for the ones we love. Around 170 employees give their best day after day in the manufacture, in customer service, in product management, marketing and the many other other areas in the HUNTER Group do their best, to let the HUNTER brand shine in the best light. All of us, completed by our beloved office dogs, we are the HUNTER family. Get to know a part of us on the following pages get to know us...





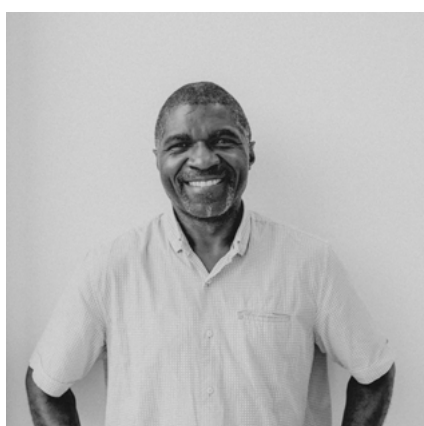
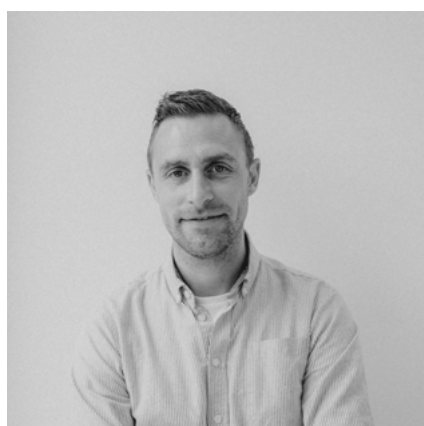
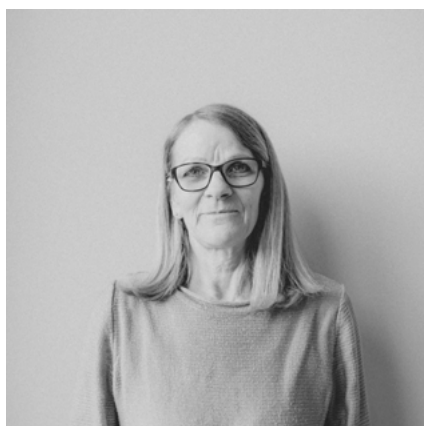



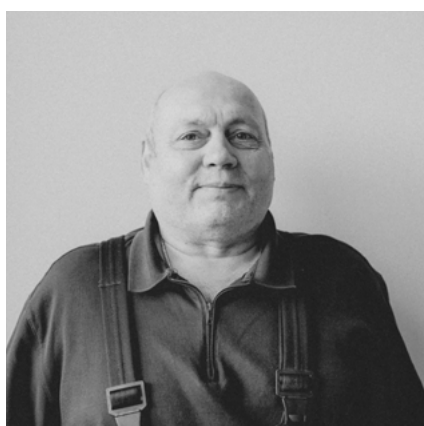

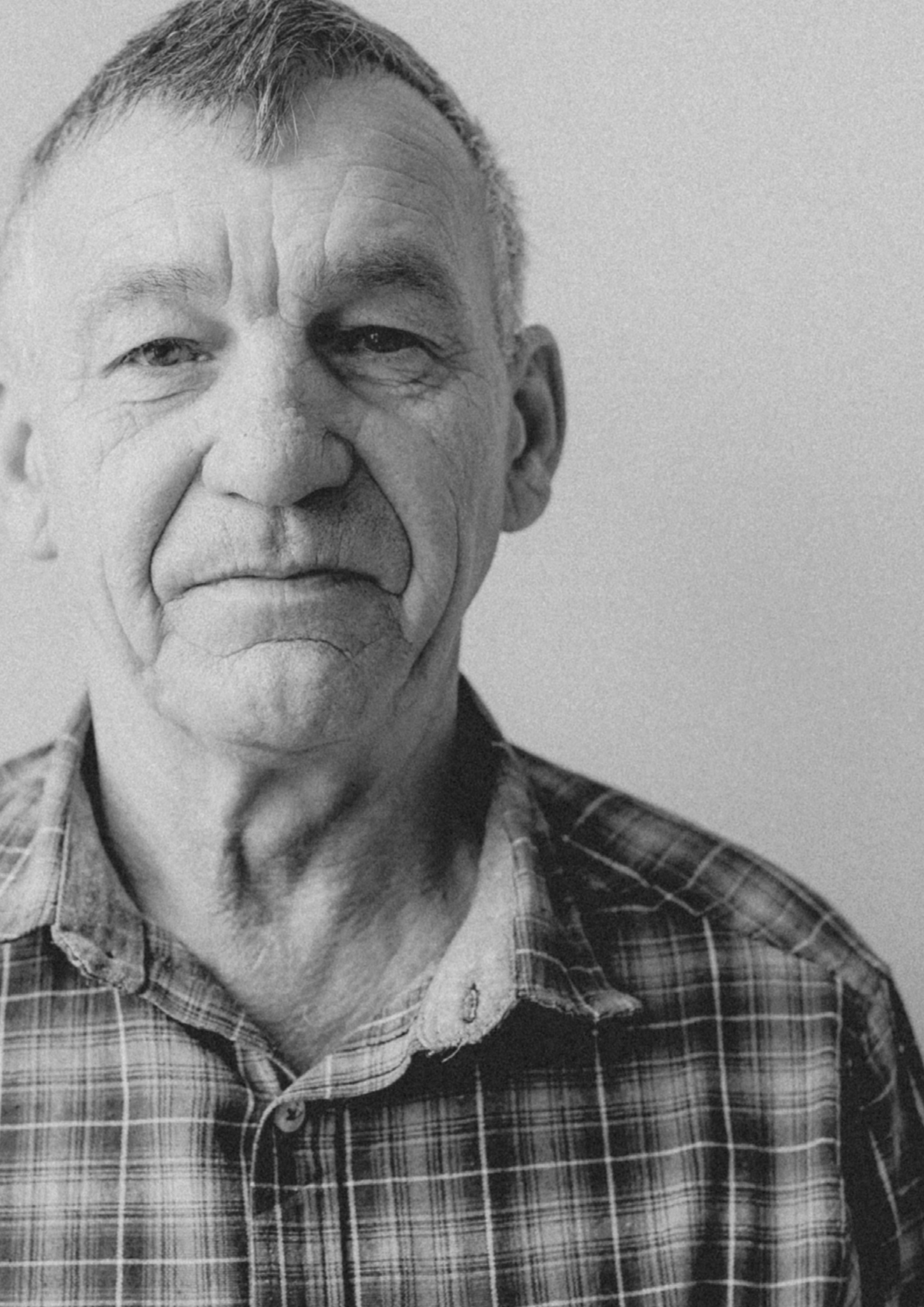

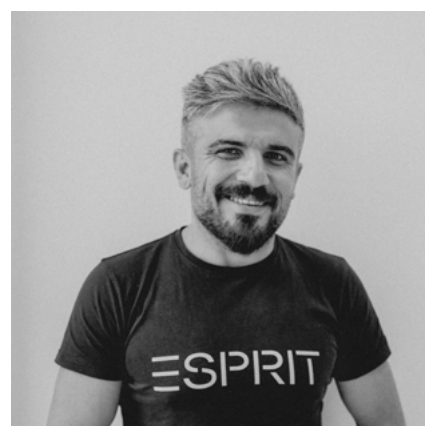



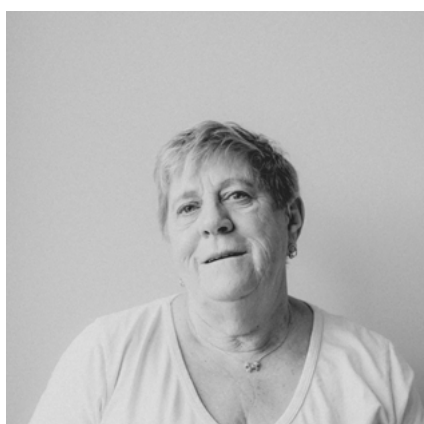
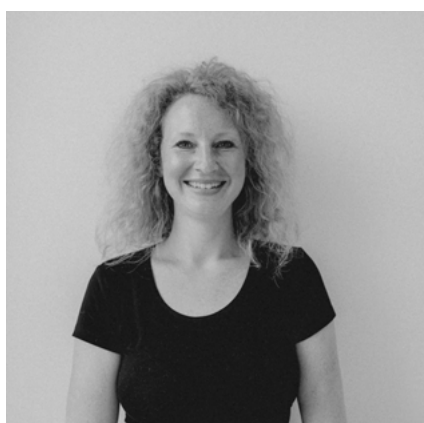

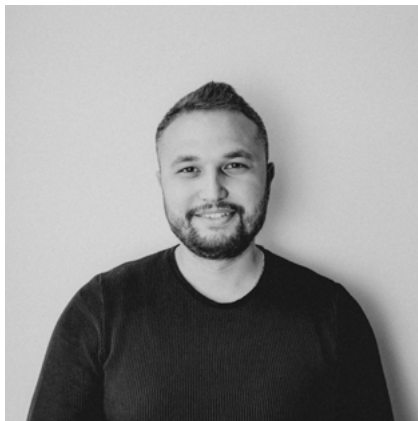

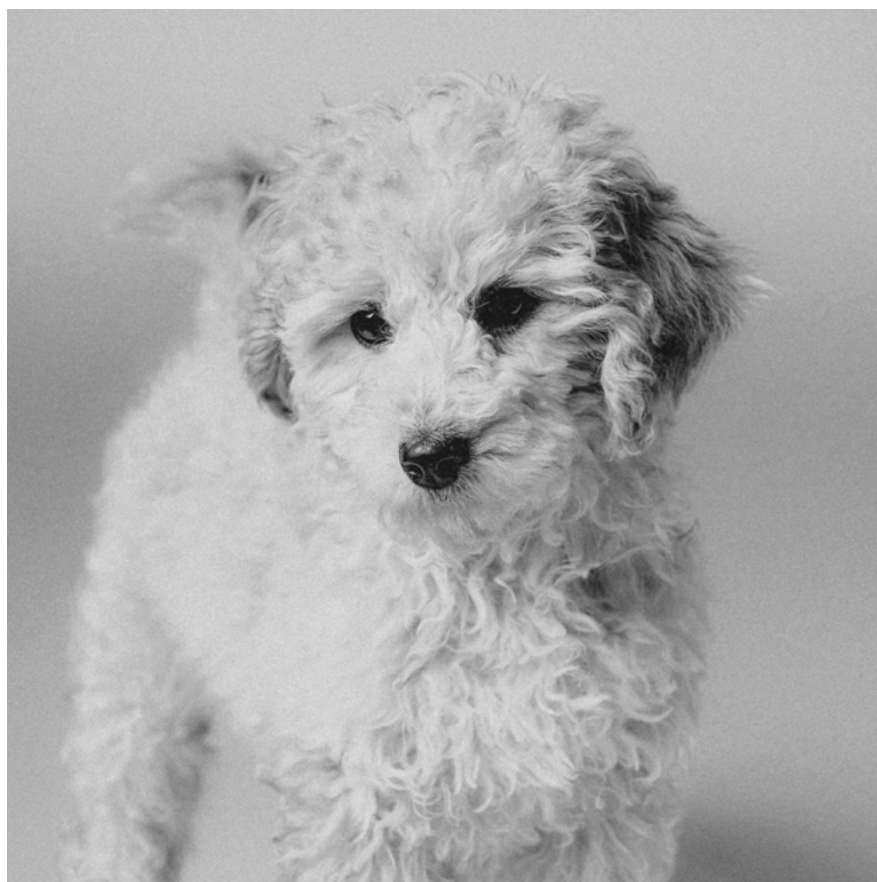

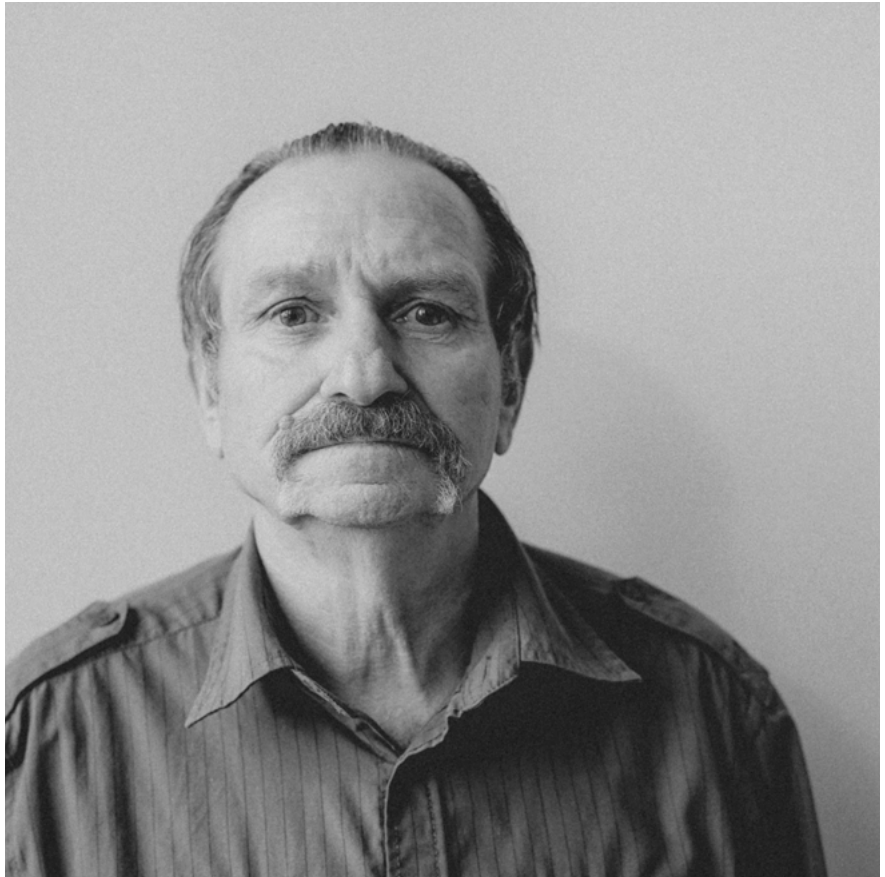









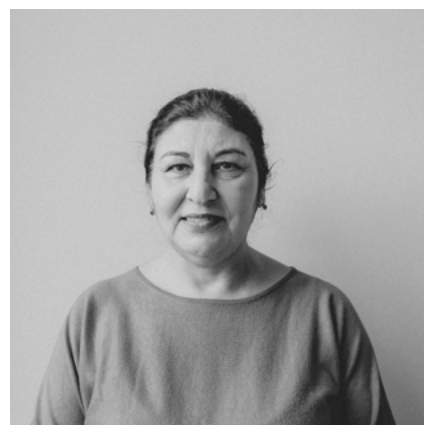

ALLGEMEINE GESCHÄFTSBEDINGUNGEN

der
HUNTER INTERNATIONAL GmbH
Mittelbreite 5, 33719 Bielefeld, Deutschland

und
Dogsport GmbH
Mittelbreite 5, 33719 Bielefeld, Deutschland

Letztmalig aktualisiert am 05.04.2018

I. Geltung der Bedingungen

1. Der Verkauf erfolgt ausschließlich an Unternehmer i.S.d. § 14 BGB. Die Lieferungen, Leistungen und Angebote des Verkäufers erfolgen ausschließlich aufgrund dieser Geschäftsbedingungen. Diese gelten somit auch für alle künftigen Geschäftsbeziehungen, auch wenn sie nicht nochmals ausdrücklich vereinbart werden. Spätestens mit der Entgegennahme der Ware oder Leistungen gelten diese Bedingungen als angenommen. Einer Gegenbestätigung des Käufers unter Hinweis auf seine Geschäfts- bzw. Einkaufsbedingungen wird hiermit widersprochen.
2. Im Einzelfall getroffene, individuelle Vereinbarungen mit dem Käufer (einschließlich Nebenabreden, Ergänzungen und Änderungen) haben in jedem Fall Vorrang vor diesen Geschäftsbedingungen. Für den Inhalt derartiger Vereinbarungen ist, vorbehaltlich des Gegenbeweises, ein schriftlicher Vertrag bzw. die schriftliche Bestätigung des Verkäufers maßgebend.
3. Der Käufer kann die derzeit gültigen Allgemeinen Geschäftsbedingungen auf der Website unter bzb.hunter.de/agb abrufen und ausdrucken.

II. Angebot, Preise

1. Die Angebote des Verkäufers, sei es online im Händlerportal unter bzb.hunter.de (im Folgenden »Händlerportal«) oder offline, sind freibleibend und unverbindlich und stellen kein verbindliches Angebot auf den Abschluss eines Kaufvertrages dar. Vielmehr handelt es sich um eine unverbindliche Aufforderung, Waren zu bestellen. Dies gilt auch, wenn der Verkäufer dem Käufer Kataloge, Dokumentationen (z.B. Zeichnungen, Pläne, Berechnungen, Kalkulationen, Verweisungen auf DIN-Normen), sonstige Produktbeschreibungen oder Unterlagen – auch in elektronischer Form – überlassen hat, an denen sich der Verkäufer Eigentums- und Urheberrechte vorbehält.
2. Mit Erscheinen eines neuen Kataloges oder einer neuen Preisliste verlieren alle vorherigen Kataloge und Preislisten ihre Gültigkeit. Auch die Katalog- und Preislistenpreise sind freibleibend bis zur Bestätigung durch den Verkäufer.
3. Die Preise gelten zuzüglich der gesetzlichen Mehrwertsteuer. Die Preise gelten Netto unfrei ab Werk. Der Versand erfolgt jeweils auf Kosten des Käufers.

III. Vertragsschluss

1. Die Bestellung der Ware durch den Käufer gilt als verbindliches Vertragsangebot.
2. Im Händlerportal kann der Verkäufer vor verbindlicher Abgabe der Bestellung seine Eingaben laufend über die üblichen Tastatur- und Mausfunktionen korrigieren. Die von dem Käufer über den Button »In den Warenkorb« ausgewählten Produkte werden dem Käufer sodann zum Abschluss des Bestellprozesses noch einmal in einer Bestellübersicht zusammengefasst. Hier sollte der Käufer alle im Rahmen des Bestellprozesses gemachten Angaben vor der verbindlichen Abgabe der Bestellung noch einmal überprüfen und über die Schaltfläche »ändern« ergänzen bzw. berichtigen. Mit Anklicken des Buttons »Jetzt zahlungspflichtig bestellen« gibt der Käufer im Händlerportal ein verbindliches Kaufangebot ab (§ 145 BGB). Nach Eingang des Kaufangebots über das Händlerportal erhält der Käufer eine automatisch erzeugte E-Mail, mit der der Verkäufer bestätigt, dass er die Bestellung des Käufers erhalten hat (Bestellbestätigung). Diese Bestellbestätigung stellt noch keine Annahme des Kaufangebots dar. Ein Vertrag kommt durch die Bestellbestätigung noch nicht zustande.
3. Der Text der Bestellung des Käufers im Händlerportal wird von dem Verkäufer gespeichert und wird dem Käufer nach Annahme seiner Bestellung durch den Verkäufer nebst den vorliegenden AGB in Textform (z.B. E-Mail, Fax oder Brief) zugeschickt. Zusätzlich wird der Vertragstext von dem Verkäufer archiviert und kann von dem Käufer über sein passwortgeschütztes Kundenkonto unter Angabe der

entsprechenden Login-Daten kostenlos abgerufen werden. Für den Vertragsschluss im Händlerportal stehen Deutsch oder Englisch als Sprachen zur Verfügung.

4. Sofern sich aus der Bestellung nichts anderes ergibt, ist der Verkäufer berechtigt, dieses Vertragsangebot innerhalb von sieben Tagen nach seinem Zugang bei dem Käufer anzunehmen.
5. Die Annahme kann entweder schriftlich (z.B. durch Auftragsbestätigung) oder durch Auslieferung der Ware an den Käufer erklärt werden. Für die Lieferung ist die schriftliche Auftragsbestätigung oder – falls eine solche nicht erteilt wird – die Rechnung des Verkäufers maßgebend.
6. Erstaufträge werden grundsätzlich gegen Vorkasse geliefert.
7. Wenn sich nach Vertragsabschluss auftragsbezogene Kosten wesentlich ändern, sind die Vertragspartner verpflichtet, sich über eine Anpassung der Preise zu verständigen. Für die Berechnung sind die vom Verkäufer ermittelten Gewichte, Stückzahlen und Mengen maßgebend, wenn der Käufer nicht unverzüglich widerspricht.

IV. Kundenkonto im Händlerportal

1. Damit der Käufer das Händlerportal des Verkäufers nutzen kann, muss nach Absprache mit dem Verkäufer ein Kundenkonto für den Käufer eingerichtet werden. In dem passwortgeschützten Kundenkonto werden die notwendigen Daten des Käufers für eine Bestellung hinterlegt, der Käufer kann nach Login den Status von getätigten Bestellungen einsehen sowie die Bestellhistorie ansehen.
2. Der Käufer verpflichtet sich, seine Login-Daten nicht an Dritte weiterzugeben.

V. Lieferung

1. Die vom Verkäufer genannten Termine und Fristen sind unverbindlich, sofern nicht ausdrücklich schriftlich etwas anderes vereinbart wurde.
2. Die Lieferfrist ist eingehalten, wenn bis zu ihrem Ablauf der Liefergegenstand das Werk verlassen hat. Sie gilt auch dann als eingehalten, wenn die Versandbereitschaft mitgeteilt ist und der Käufer den Liefergegenstand innerhalb der Lieferfrist nicht abnimmt.
3. Sofern der Verkäufer verbindliche Lieferfristen aus Gründen, die der Verkäufer nicht zu vertreten hat, nicht einhalten kann (Nichtverfügbarkeit der Leistung), wird der Verkäufer den Käufer hierüber unverzüglich informieren und gleichzeitig die voraussichtliche neue Lieferfrist mitteilen. Ist die Leistung auch innerhalb der neuen Lieferfrist nicht verfügbar, ist der Verkäufer berechtigt, ganz oder teilweise vom Vertrag zurückzutreten; eine bereits erbrachte Gegenleistung des Käufers wird der Verkäufer unverzüglich erstatten. Als Fall der Nichtverfügbarkeit der Leistung in diesem Sinne gilt insbesondere die nicht rechtzeitige Selbstbelieferung durch einen Zulieferer des Verkäufers, wenn der Verkäufer ein kongruentes Deckungsgeschäft abgeschlossen hat, weder den Verkäufer noch seinen Zulieferer ein Verschulden trifft oder der Verkäufer im Einzelfall zur Beschaffung nicht verpflichtet ist.
4. Angemessene Teillieferungen sind zulässig. Die Lieferungen erfolgen in der Regel in Standardverpackungen. Soweit das nicht der Fall ist, sind handelsübliche Abweichungen von den vereinbarten Liefermengen zulässig.
5. Der Eintritt des Lieferverzugs bestimmt sich nach den gesetzlichen Vorschriften. In jedem Fall ist aber eine Mahnung durch den Käufer erforderlich. Gerät der Verkäufer in Lieferverzug, gelten die entsprechenden gesetzliche Ansprüche und Rechte des Käufers.
6. Die Rechte des Käufers gem. VIII. und IX. dieser AGB und die gesetzlichen Rechte des Verkäufers, insbesondere bei einem Ausschluss der Leistungspflicht (z.B. aufgrund Unmöglichkeit oder Unzumutbarkeit der Leistung und/oder Nacherfüllung), bleiben unberührt.
7. Die Lieferpflicht des Verkäufers ruht, solange der Käufer mit einer fälligen Zahlung trotz Mahnung im Rückstand ist.

8. Ist die Ware innerhalb eines bestimmten Zeitraums nach und nach abzunehmen, so ist die Abnahme, wenn nicht ausdrücklich etwas anderes vereinbart wurde, gleichmäßig über den Gesamtzeitraum zu verteilen. Bleibt der Käufer mit der Abnahme vereinbarter Teilmengen zurück, so ist der Verkäufer befugt, nach Gewährung einer angemessenen Nachfrist die entsprechende Menge für Rechnung und auf eigene Gefahr des Käufers einzulagern oder sie von der Abschlussmenge zu streichen. Im letztgenannten Fall entfallen auch die für bereits gelieferte Waren eingeräumten Sonderkonditionen.

VI. Versand, Gefahrübergang, Verpackung

1. Sofern nicht anders vereinbart, wählt der Verkäufer Versandweg und Versandart, wobei die Interessen des Käufers angemessen zu berücksichtigen sind. Auf Wunsch des Käufers wird zusätzlich zu den Versandkosten auf seine Kosten die Sendung durch den Verkäufer gegen Diebstahl, Bruch, Transport-, Feuer- u. Wasserschäden sowie sonstige versicherbare Risiken versichert.
2. Die Gefahr für Untergang, Verlust oder Beschädigung der Ware geht mit deren Absendung oder im Falle der Abholung mit der dem Käufer mitgeteilten Bereitstellung auf diesen über. Das gilt auch bei frachtfreier Lieferung. Verzögert sich der Versand infolge von Umständen, die der Käufer zu vertreten hat, so geht die Gefahr vom Tage der Versandbereitschaft ab auf diesen über; jedoch ist der Verkäufer verpflichtet, auf Wunsch und Kosten des Käufers die Versicherungen zu bewirken, die dieser verlangt.
3. Angelieferte Waren sind, auch wenn sie unwesentliche Mängel aufweisen, vom Käufer unbeschadet der Rechte aus Ziff. VIII. abzunehmen.

VII. Zahlungen

1. Die Rechnungen sind zahlbar gemäß den vereinbarten Zahlungsbedingungen. Zahlungen gelten erst dann als bewirkt, wenn der Betrag auf einem Konto des Verkäufers endgültig verfügbar ist. Der Verkäufer behält sich auch bei anderweitigen Zahlungsbestimmungen des Käufers vor, Zahlungen zur Begleichung der ältesten Rechnungsposten zuzüglich der darauf aufgelaufenen Verzugszinsen und Kosten zu verwenden, und zwar in der Reihenfolge: Kosten, Zinsen, Hauptforderung. Forderungen, denen gegenüber der Einwand der berechtigten Mängelrüge erhoben worden ist, sind von dieser Regelung ausgenommen. Dem Käufer steht ein Zurückbehaltungs- oder Aufrechnungsrecht nur zu, sofern seine Ansprüche rechtskräftig festgestellt oder unbestritten sind. Bei Mängeln der Lieferung bleiben die Gegenrechte des Käufers unberührt.
2. Wird nach Abschluss des Vertrags erkennbar (z.B. durch Antrag auf Eröffnung eines Insolvenzverfahrens), dass der Anspruch des Verkäufers auf den Kaufpreis durch mangelnde Leistungsfähigkeit des Käufers gefährdet wird, so ist der Verkäufer nach den gesetzlichen Vorschriften zur Leistungsverweigerung und – gegebenenfalls nach Fristsetzung – zum Rücktritt vom Vertrag berechtigt (§ 321 BGB). Bei Verträgen über die Herstellung unvertretbarer Sachen (Einzelfertigungen) kann der Verkäufer den Rücktritt sofort erklären; die gesetzlichen Regelungen über die Entbehrlichkeit der Fristsetzung bleiben unberührt.
3. Gerät der Käufer in Verzug, so ist der Verkäufer berechtigt, von dem betreffenden Zeitpunkt ab Zinsen in Höhe des von seinen Geschäftsbanken berechneten Zinssatzes für offene Kontokorrentkredite, mindestens jedoch in Höhe von 9%-Punkten über dem jeweiligen Basiszinssatz zu berechnen.

VIII. Rügepflicht, Mängelrechte

1. Die Mängelansprüche des Käufers setzen voraus, dass er seinen gesetzlichen Untersuchungs- und Rügepflichten (§§ 377, 381 HGB) nachgekommen ist. Zeigt sich bei der Lieferung, der Untersuchung oder zu irgendeinem späteren Zeitpunkt ein Mangel, so ist dem Verkäufer hiervon unverzüglich schriftlich Anzeige zu machen. In jedem Fall sind offensichtliche Mängel innerhalb von 7 Arbeitstagen ab Lieferung und bei der Untersuchung nicht erkennbare Mängel innerhalb der gleichen Frist ab Entdeckung schriftlich anzuzeigen. Versäumt der Käufer die ordnungsgemäße Untersuchung und/oder Mängelanzeige, ist die Haftung des Verkäufers für den nicht bzw. nicht rechtzeitig oder nicht ordnungsgemäß angezeigten Mangel nach den gesetzlichen Vorschriften ausgeschlossen.
2. Ist die gelieferte Sache mangelhaft, kann der Verkäufer zunächst wählen, ob er Nacherfüllung durch Beseitigung des Mangels (Nachbesserung) oder durch Lieferung einer mangelfreien Sache (Ersatzlieferung) leistet. Das Recht des Verkäufers, die Nacherfüllung unter den gesetzlichen Voraussetzungen zu verweigern, bleibt unberührt.
3. Der Verkäufer ist berechtigt, die geschuldete Nacherfüllung davon abhängig zu machen, dass der Käufer den fälligen Kaufpreis bezahlt. Der Käufer ist jedoch berechtigt, einen im Verhältnis zum Mangel angemessenen Teil des Kaufpreises zurückzubehalten.
4. Der Käufer hat dem Verkäufer die zur geschuldeten Nacherfüllung erforderliche Zeit und Gelegenheit zu geben, insbesondere die beanstandete Ware zu Prüfungszwecken zu übergeben. Im Falle der Ersatzlieferung hat der Käufer dem Verkäufer die mangelhafte Sache nach den gesetzlichen Vorschriften zurückzugeben. Die Nacherfüllung beinhaltet weder den Ausbau der mangelhaften Sache noch den erneuten Einbau, wenn der Verkäufer ursprünglich nicht zum Einbau verpflichtet war.
5. Die zum Zweck der Prüfung und Nacherfüllung erforderlichen Aufwendungen, insbesondere Transport-, Wege-, Arbeits- und Materialkosten (nicht: Ausbau- und Einbaukosten), trägt der Verkäufer, wenn tatsächlich ein Mangel vorliegt. Andernfalls kann der Verkäufer vom Käufer die aus dem unberechtigten Mangelbeseitigungsverlangen entstandenen Kosten (insbesondere Prüf- und Transportkosten) ersetzt verlangen, es sei denn, die fehlende Mangelhaftigkeit war für den Käufer nicht erkennbar.
6. In dringenden Fällen, z.B. bei Gefährdung der Betriebssicherheit oder zur Abwehr unverhältnismäßiger Schäden, hat der Käufer das Recht, den Mangel selbst zu beseitigen und von dem Verkäufer Ersatz der hierzu objektiv erforderlichen Aufwendungen zu verlangen. Von einer derartigen Selbstvornahme ist der Verkäufer unverzüglich, nach Möglichkeit vorher, zu benachrichtigen. Das Selbstvornahmerecht besteht nicht, wenn der Verkäufer berechtigt wäre, eine entsprechende Nacherfüllung nach den gesetzlichen Vorschriften zu verweigern.
7. Wenn die Nacherfüllung fehlgeschlagen ist oder eine für die Nacherfüllung vom Käufer zu setzende angemessene Frist erfolglos abgelaufen oder nach den gesetzlichen Vorschriften entbehrlich ist, kann der Käufer vom Kaufvertrag zurücktreten oder den Kaufpreis mindern. Bei einem unerheblichen Mangel besteht jedoch kein Rücktrittsrecht.
8. Ansprüche des Käufers auf Schadensersatz bzw. Ersatz vergeblicher Aufwendungen bestehen auch bei Mängeln nur nach Maßgabe von IX. dieser Allgemeinen Geschäftsbedingungen und sind im Übrigen ausgeschlossen.
9. Wird der Käufer im Wege des Rückgriffs gem. §§ 478 f. BGB von seinem Käufer in Anspruch genommen, so ist er verpflichtet, dem Verkäufer diese Inanspruchnahme unverzüglich, spätestens binnen vierzehn Tagen, schriftlich anzuzeigen. Bevor der Käufer seinerseits die Ware zurücknimmt oder nachbessert oder Minderung akzeptiert oder Schadenersatz leistet, ist er verpflichtet, dem Verkäufer die Möglichkeit der Nachbesserung oder Neulieferung einzuräumen. Der Käufer ist verpflichtet, diese Regelung seinem Käufer, sofern dieser kein Verbraucher ist, ebenfalls aufzuerlegen. Die Geltendmachung von Schadensersatzansprüchen im Wege des Rückgriffs ist in jedem Fall ausgeschlossen.

10. Beanstandete Ware darf erst nach Ablauf der angemessenen Frist gemäß VIII Ziffer 4 ohne ausdrückliche Einwilligung des Verkäufers zurückgesandt werden.
11. Ansprüche wegen jeglicher Mängel verjähren innerhalb von einem Jahr ab der Ablieferung der Sache. Bei Schadenersatzansprüchen wegen der Verletzung von Leben, Körper und Gesundheit sowie bei Schadenersatzansprüchen wegen vorsätzlicher oder grob fahrlässiger Pflichtverletzung (Ziff. IX. dieser AGB) gilt die gesetzliche Verjährungsregelung.

IX. Haftung

1. Soweit sich aus diesen Allgemeinen Geschäftsbedingungen einschließlich der nachfolgenden Bestimmungen nichts anderes ergibt, haftet der Verkäufer bei einer Verletzung von vertraglichen und außervertraglichen Pflichten nach den gesetzlichen Vorschriften.
2. Auf Schadenersatz der Verkäufer – gleich aus welchem Rechtsgrund – im Rahmen der Verschuldenshaftung bei Vorsatz und grober Fahrlässigkeit. Bei einfacher Fahrlässigkeit haftet der Verkäufer vorbehaltlich eines mildernden Haftungsmaßstabs nach gesetzlichen Vorschriften (z.B. für Sorgfalt in eigenen Angelegenheiten) nur
 - a) für Schäden aus der Verletzung des Lebens, des Körpers oder der Gesundheit,
 - b) für Schäden aus der nicht unerheblichen Verletzung einer wesentlichen Vertragspflicht (Verpflichtung, deren Erfüllung die ordnungsgemäße Durchführung des Vertrags überhaupt erst ermöglicht und auf deren Einhaltung der Vertragspartner regelmäßig vertraut und vertrauen darf); in diesem Fall ist die Haftung des Verkäufers jedoch auf den Ersatz des vorhersehbaren, typischerweise eintretenden Schadens begrenzt.
3. Die sich aus IX Ziffer 2 ergebenden Haftungsbeschränkungen gelten auch bei Pflichtverletzungen durch bzw. zugunsten von Personen, deren Verschulden der Verkäufer nach gesetzlichen Vorschriften zu vertreten hat. Sie gelten nicht, soweit der Verkäufer einen Mangel arglistig verschwiegen oder eine Garantie für die Beschaffenheit der Ware übernommen hat und für Ansprüche des Käufers nach dem Produkthaftungsgesetz.
4. Wegen einer Pflichtverletzung, die nicht in einem Mangel besteht, kann der Käufer nur zurücktreten oder kündigen, wenn der Verkäufer die Pflichtverletzung zu vertreten hat. Ein freies Kündigungsrecht des Käufers (insbesondere gem. §§ 651, 649 BGB) wird ausgeschlossen. Im Übrigen gelten die gesetzlichen Voraussetzungen und Rechtsfolgen.

X. Eigentumsvorbehalt

1. Bis zur vollständigen Bezahlung aller gegenwärtigen und künftigen Forderungen des Verkäufers aus dem Kaufvertrag und einer laufenden Geschäftsbeziehung (gesicherte Forderungen) behält sich der Verkäufer das Eigentum an den verkauften Waren vor.
2. Die unter Eigentumsvorbehalt stehenden Waren dürfen vor vollständiger Bezahlung der gesicherten Forderungen weder an Dritte verpfändet, noch zur Sicherheit übereignet werden. Der Käufer hat den Verkäufer unverzüglich schriftlich zu benachrichtigen, wenn ein Antrag auf Eröffnung eines Insolvenzverfahrens gestellt oder soweit Zugriffe Dritter (z.B. Pfändungen) auf die uns gehörenden Waren erfolgen.
3. Der Käufer ist verpflichtet, die Vorbehaltsware für den Verkäufer sorgfältig zu verwahren und auf eigene Kosten ordnungsgemäß gegen Abhandenkommen und Beschädigung zu versichern. Er tritt seine Ansprüche aus den Versicherungsverträgen hiermit im Voraus ab.
4. Bei vertragswidrigem Verhalten des Käufers, insbesondere bei Nichtzahlung des fälligen Kaufpreises, ist der Verkäufer berechtigt, nach den gesetzlichen Vorschriften vom Vertrag zurückzutreten oder/und die Ware auf Grund des Eigentumsvorbehalts heraus zu verlangen. Das Herausgabeverlangen beinhaltet nicht zugleich die Erklärung des Rücktritts; der Verkäufer ist vielmehr berechtigt, lediglich die Ware

- heraus zu verlangen und sich den Rücktritt vorzubehalten. Zahlt der Käufer den fälligen Kaufpreis nicht, darf der Verkäufer diese Rechte nur geltend machen, wenn der Verkäufer dem Käufer zuvor erfolglos eine angemessene Frist zur Zahlung gesetzt haben oder eine derartige Fristsetzung nach den gesetzlichen Vorschriften entbehrlich ist.
5. Der Käufer ist bis auf Widerruf gemäß unten IX. Ziffer 8 befugt, die unter Eigentumsvorbehalt stehenden Waren im ordnungsgemäßen Geschäftsgang weiter zu veräußern und/oder zu verarbeiten. In diesem Fall gelten ergänzend die nachfolgenden Bestimmungen.
6. Der Eigentumsvorbehalt erstreckt sich auf die durch Verarbeitung, Vermischung oder Verbindung der Waren des Verkäufers entstehenden Erzeugnisse zu deren vollem Wert, wobei der Verkäufer als Hersteller gilt. Bleibt bei einer Verarbeitung, Vermischung oder Verbindung mit Waren Dritter deren Eigentumsrecht bestehen, so erwirbt der Verkäufer Miteigentum im Verhältnis der Rechnungswerte der verarbeiteten, vermischten oder verbundenen Waren. Im Übrigen gilt für das entstehende Erzeugnis das Gleiche wie für die unter Eigentumsvorbehalt gelieferte Ware.
7. Die aus dem Weiterverkauf der Ware oder des Erzeugnisses entstehenden Forderungen gegen Dritte tritt der Käufer schon jetzt insgesamt bzw. in Höhe des etwaigen Miteigentumsanteils des Verkäufers gemäß vorstehendem Absatz zur Sicherheit an den Verkäufer ab. Der Verkäufer nimmt die Abtretung an. Die in IX Ziffer 2 und 3 genannten Pflichten des Käufers gelten auch in Ansehung der abgetretenen Forderungen.
8. Zur Einziehung der Forderung bleibt der Käufer neben dem Verkäufer ermächtigt. Der Verkäufer verpflichtet sich, die Forderung nicht einzuziehen, solange der Käufer seinen Zahlungsverpflichtungen dem Verkäufer gegenüber nachkommt, kein Mangel seiner Leistungsfähigkeit vorliegt und der Verkäufer den Eigentumsvorbehalt nicht durch Ausübung eines Rechts gem. IX Ziffer 4 geltend macht. Ist dies aber der Fall, so kann der Verkäufer verlangen, dass der Käufer dem Verkäufer die abgetretenen Forderungen und deren Schuldner bekannt gibt, alle zum Einzug erforderlichen Angaben macht, die dazugehörigen Unterlagen aushändigt und den Schuldnern (Dritten) die Abtretung mitteilt. Außerdem ist der Verkäufer in diesem Fall berechtigt, die Befugnis des Käufers zur weiteren Veräußerung und Verarbeitung der unter Eigentumsvorbehalt stehenden Waren zu widerrufen.
9. Übersteigt der realisierbare Wert der Sicherheiten die Forderungen des Verkäufers um mehr als 10%, wird der Verkäufer auf Verlangen des Käufers Sicherheiten nach Wahl des Verkäufers freigeben.
10. Der Käufer ist auf Verlangen des Verkäufers verpflichtet, den Erwerb der Abtretung bekanntzugeben und dem Verkäufer die zur Geltendmachung seiner Rechte gegen die Erwerber erforderlich Auskünfte zu geben und Unterlagen auszuhändigen. Es ist dem Käufer untersagt, mit seinem Abnehmer Abreden zu treffen, welche die Rechte des Verkäufers in irgendeiner Weise ausschließen oder beeinträchtigen können. Der Käufer darf insbesondere keine Vereinbarungen eingehen, welche die Vorausabtretung der Forderungen an den Verkäufer zunichtemacht oder beeinträchtigt.

XI. Rechtswahl, Erfüllungsort, Gerichtsstand, Teilnichtigkeit

1. Für die gesamte Geschäftsbeziehung zwischen Verkäufer und Käufer findet deutsches Recht (HGB, BGB) unter Ausschluss des UN-Kaufrechts Anwendung.
2. Erfüllungsort für die Lieferung ist die jeweilige Versandstelle des Verkäufers, für die Zahlung dessen Sitz.
3. Der Gerichtsstand für alle Streitigkeiten ist Bielefeld.
4. Sollten einzelne Klauseln dieser Verkaufs- und Lieferungsbedingungen ganz oder teilweise ungültig sein, so berührt das die Wirksamkeit der übrigen Klauseln nicht. Eine unwirksame Regelung gilt als durch eine solche Regelung ersetzt, die dem wirtschaftlichen Zweck der unwirksamen Regelung am nächsten kommt und wirksam ist.

GENERAL TERMS AND CONDITIONS

of
HUNTER INTERNATIONAL GmbH
Mittelbreede 5, 33719 Bielefeld, Germany

and
Dogsport GmbH
Mittelbreede 5, 33719 Bielefeld, Germany

Last updated: 05 April 2018

I. Scope of the Terms and Conditions

1. Sale is exclusively to business entities within the meaning of Sec. 14 German Civil Code (Bürgerliches Gesetzbuch, BGB). Supply of goods, supply of services and offers of sale of Vendor are made exclusively on the basis of these Terms and Conditions. Therefore, these Terms and Conditions also apply to all future business relationships, even if this is not expressly stated in each case. These Terms and Conditions shall be deemed to have been accepted at the latest on receipt of the goods or services. A counter-confirmation from Purchaser making reference to their terms or purchasing conditions is hereby expressly rejected.
2. Individual agreements concluded with Purchaser in individual cases (including side agreements, amendments or alterations) will always take precedence over these Terms and Conditions. Subject to evidence to the contrary, the content of such agreements shall require a written contract or written confirmation from Vendor.
3. Purchaser can retrieve and print the current version of the Terms and Conditions from the website b2b.hunter.de/agb.

II. Offer of sale, prices

1. Vendor's offers of sale, whether online on the dealer portal b2b.hunter.de (hereinafter: "Dealer Portal") or offline, are subject to change and non-binding and do not represent binding offers to conclude a contract of sale. Instead, it constitutes a non-binding invitation to order goods. This also applies if Vendor has provided Purchaser with catalogues, documentation (e.g. drawings, plans, calculations, estimations, references to DIN standards), other product descriptions or paperwork - including in electronic form - in which Vendor holds property rights and copyright.
2. Upon publication of a new catalogue or price list, all previous catalogues and price lists become invalid. The catalogue and price list prices also remain subject to change until confirmed by Vendor.
3. The prices are exclusive of statutory VAT. All prices listed are ex works. Shipping in all cases is at Purchaser's cost.

III. Conclusion of Agreement

1. An order for goods placed by Purchaser will be deemed a binding offer to conclude a contract.
2. On the Dealer Portal, Vendor can use the usual keyboard and mouse functions to correct the information it has entered at any point prior to the binding submission of the order. The products selected by Purchaser using the "Add to shopping cart" button will then be summarised for Purchaser in an order overview at the end of the order process. At this point, Purchaser should double-check all information provided in the scope of the order process prior to submitting the binding order and amend or correct it accordingly using the "amend" button. By clicking the button "Place order and pay", Purchaser thereby makes a binding offer to purchase on the Dealer Portal (Sec. 145 BGB). After the offer to purchase via Dealer Website has been submitted, Purchaser will receive an automatically generated email, with which Vendor confirms that it has received Purchaser's order (Order Confirmation). This Order Confirmation does not yet represent an acceptance of the offer to purchase. The Order Confirmation does not yet mean that a contract has been concluded.
3. The text of Purchaser's order on the Dealer Portal is saved by Vendor and will be sent to Purchaser by Vendor following acceptance of their order together with these Terms and Conditions in written form (e.g. email, fax or letter). In addition, the contract text will be archived by Vendor and can be retrieved by Purchaser, free of charge, via their password protected customer account, by providing the relevant login data. Contracts can be concluded on the Dealer Portal in either English or German.
4. Unless otherwise stated in the order, Vendor is entitled to accept this offer to conclude a contract within seven days of receipt by Vendor.

5. Acceptance may be declared either in writing (e.g. by way of a separate Acceptance of Order) or by way of delivery of the goods to Purchaser. The relevant record in respect of the delivery of goods is the written Acceptance of Order or - if one is not issued - Vendor's invoice.
6. First time orders will generally only be upon receipt of prepayment.
7. If, following conclusion of the contract, order related costs significantly change, the contracting parties are obligated to agree on a price adjustment. The respective calculation will be based on the weights, numbers of units and quantities unless Purchaser immediately objects.

IV. Customer account on Dealer Portal

1. In order that Purchaser is able to use Vendor's Dealer Portal, a customer account for Purchaser must be created, with Vendor's agreement. All Purchaser information required for placing orders will be stored in the password protected customer account; after logging in, Purchaser can check the status of their existing orders and view their order history.
2. Purchaser undertakes not to disclose their login data to third parties.

V. Delivery

1. The dates and time limits stated by Vendor are non-binding, unless otherwise expressly set out in writing.
2. The delivery period is deemed to have been complied with, if the object of delivery has been dispatched before expiry of the delivery period. It is equally deemed to have been complied with if the readiness for despatch has been communicated and Purchaser fails to accept the object of delivery within the delivery period.
3. To the extent that Vendor is unable to comply with binding delivery periods due to reasons for which Vendor is not responsible (impossibility of performance), Vendor will inform Purchaser thereof without delay whilst also notifying Purchaser of the expected new delivery period. If performance is also impossible within the new delivery period, Vendor is entitled to withdraw, partially or fully, from the contract; any consideration already made by Purchaser will be reimbursed immediately by Vendor. An example of impossibility of performance within the meaning of this clause is, in particular, if delivery from one of Vendor's own suppliers is delayed, if Vendor has concluded a congruent covering supply arrangement, if neither Vendor nor Vendor's supplier is responsible or if Vendor is not obligated to supply in a given case.
4. Reasonable partial deliveries are permitted. Deliveries will generally be made using standard packaging. If this is not the case, deviations from the agreed delivery quantities according to standard industry practices are permitted.
5. A default of delivery will be deemed to have taken effect as per the respective statutory provisions. In any case, however, a written notification from Purchaser is required. Should the vendor fail to deliver on time, the corresponding legal claims and rights of the purchaser apply.
6. Purchaser's rights under VIII. and IX. of these terms and conditions and Vendor's statutory rights, in particular in the event of an exclusion of the obligation to perform (e.g. due to impossibility or unreasonableness of performance and/or subsequent performance), remain unaffected.
7. Vendor's delivery obligation is suspended, for as long as Purchaser is in arrears with a due payment despite a reminder.
8. If the goods are to be gradually called off over a determined time period, the call off is must, unless otherwise expressly set out, be spread evenly over the entire time period. If Purchaser falls behind with the call off of the agreed partial quantities, Vendor is authorised, after granting a reasonable extension to the time limit, to store the corresponding quantity for Purchaser's account and at Purchaser's own risk or to remove it from the final quantity. In the latter case, the special conditions granted for the goods already delivered also cease to apply.

VI. Shipping, transfer of risk, packaging

1. Unless otherwise agreed, Vendor shall select the shipment route and method of shipment, taking due account of Purchaser's interests. At Purchaser's request, shipments from Vendor can be insured against theft, breakage, transport, fire and water damage as well as other insurable risks at Purchaser's expense in addition to the shipping costs.
2. The risk of goods being destroyed, lost or damaged is transferred to Purchaser upon dispatch or, in the case of collection, upon communication of their readiness for dispatch. The same applies in respect of carriage-paid deliveries. If shipment is delayed due to circumstances for which Purchaser is responsible, the risk passes to Purchaser from the date on which the goods are ready for despatch; Vendor is, however, obligated, at Purchaser's request and at Purchaser's request, to effect any insurance requested by Purchaser.
3. Goods delivered to Purchaser, even if there is evidence of minor defects, must be accepted by Purchaser without prejudice to the rights in VIII.

VII. Payments

1. Invoices are payable as per the agreed payment terms. A payment is only considered to have been effected when the amount is showing as definitively available in Vendor's account. Even where Purchaser's payment terms stipulate otherwise, Vendor reserves the right to apply payments received to the oldest invoice item, plus the default interest accrued and costs, specifically in the following order: costs, interest, principal claim. Claims, against which the objection of justified notification of defects has been raised, are excluded from this provision. Purchaser is only entitled to a right of retention or offsetting where their claims have been determined as final by a competent court or are undisputed. In the case of defective delivery, Purchaser's opposing rights remain unaffected.
2. If, following conclusion of the contract, it becomes apparent (e.g. by an application to institute insolvency proceedings) that Vendor's entitlement to the purchase price is in jeopardy due to Purchaser's inability to perform, Vendor is entitled, according to the statutory provisions, to refuse performance and - if necessary after setting a deadline - to withdraw from the contract (Sec. 321 BGB). As far as contracts for the manufacture of custom goods (one-off production) are concerned, Vendor can declare immediate withdrawal from the contract; statutory regulations regarding the unnecessary setting of a deadline remain unaffected.
3. If Purchaser is in default, Vendor is entitled to charge interest from the relevant point in time, at the level of interest charged by its commercial bank for active overdrafts, at least however in the amount of 9 percentage points above the respective base rate.

VIII. Obligation to give notice of defects, rights regarding defects

1. Purchaser's claims for defects depend on their having complied with their statutory inspection obligations and obligations to give notice of defects (Sec. 377, Sec. 381 German Commercial Code (Handelsgesetzbuch, HGB)). If a defect is present at the time of delivery, inspection or at any other later time, Vendor must be notified thereof in writing without delay. In any case, obvious defects must be reported in writing within 7 working days of delivery, and any defects that cannot be identified during inspection must be reported in writing within the same time limit from the time of discovery. If Purchaser fails to carry out the proper inspection and/or notification of defects, Vendor's liability for a defect that is not notified, or not notified in a timely manner or not properly notified, is excluded according to the relevant statutory provisions.
2. If the delivered item is defective, Vendor can first choose whether to provide subsequent performance by remedying the defect (repair) or by delivering an item free from defects (replacement delivery). Vendor's right to refuse subsequent performance under statutory requirements remains unaffected.

3. Vendor is entitled to make the subsequent performance owed dependent on Purchaser having already paid purchase price due. Purchaser is however entitled to withhold a part of the purchase price which is reasonable in relation to the defect.
4. Purchaser shall give Vendor the time and opportunity required to provide the subsequent performance, in particular to hand over the goods concerned for inspection purposes. In the case of replacement delivery, Purchaser shall return to Vendor the defective item according to the relevant statutory provisions. The subsequent performance includes neither deinstallation of the defective item nor installation of the replacement, if Vendor was not originally obliged to install the relevant item.
5. The cost and effort required to carry out the assessment and subsequent performance, in particular transport, travel, work and material costs (not: deinstallation and installation costs) shall be borne by Vendor, where a defect actually exists. If this is not the case, Vendor can demand from Purchaser the corresponding costs incurred from the unjustified request for remedy of the defect (in particular assessment and transport costs), unless the lack of defect was not apparent to Purchaser.
6. In urgent cases, e.g. when operational reliability is jeopardised or to avoid disproportionate damages, Purchaser has the right to remedy the defect itself and to demand reimbursement for the objectively required expenditure to this end. Vendor must be informed without delay about any such activity, if possible beforehand. The right to remedy defects shall not exist if Vendor would have been entitled to refuse the corresponding subsequent performance in accordance with statutory provisions.
7. If the subsequent performance fails or if Purchaser's reasonable deadline for subsequent performance expires fruitlessly or where subsequent performance is unnecessary under the relevant statutory provisions, Purchaser may withdraw from the contract of sale or reduce the purchase price. However, no such right of withdrawal exists for insignificant defects.
8. Purchaser's claims for damages or reimbursement of wasted expenditure also exist, even where defects exist, in accordance with the provisions of IX. of these General Terms and Conditions and are otherwise excluded.
9. If Purchaser has a claim asserted against it by its customer by way of recourse as per Sec. 478 et seq. BGB, Purchaser is thereby obligated to inform Vendor of this claim without delay and in writing, at the latest within fourteen days. Before Purchaser for its part takes the goods back or effects repairs or accepts a price reduction or pays compensation, it is obligated to grant Vendor the opportunity to repair or replace. Purchaser is obligated also to impose this rule on its customer, provided that is not a consumer. The assertion of claims for damages by way of recourse is any case excluded.
10. Contested goods may be returned without Vendor's express consent only after expiry of the reasonable time limit as per VIII point 4.
11. Claims due to any defects are statute barred after one year from the date of delivery of the goods. The statute of limitations under the law applies to claims for damages due to injuries to life, body and health as well as claims for damages due to intentional or grossly negligent violation of obligations (IX. of these Terms and Conditions).

IX. Liability

1. Unless otherwise stipulated in these General Terms and Conditions including the following provisions, Vendor is liable in the event of violation of contractual and non-contractual obligations in accordance with the relevant statutory provisions.
2. Vendor is liable to pay damages - regardless of the legal grounds - in the scope of tortious liability in the case of intent and gross negligence. In the case of simple negligence, Vendor is liable subject to milder liability criteria in accordance with the relevant statutory provisions (e.g. the duty of care in its own affairs) only

- a) for damage or loss arising from injury to life, body or health,
 - b) for damage or loss arising from the not insignificant violation of a material contractual obligation (an obligation which must be fulfilled to enable the due and proper performance of the contract and the observance of which the respective other party to the contract will usually rely on and be entitled to rely on); in this case, Vendor's liability is limited, however, to compensation for damage or losses which can typically be foreseen in this type of transaction.
3. The limitations of liability which follow from IX. point 2 also apply to breaches of obligations by or to the benefit of persons, for whose actions Vendor bears responsibility under the relevant statutory provisions. They do not apply in cases where Vendor has maliciously concealed a defect, or has provided a guarantee for the quality of the goods, and for Purchaser's claims according to the German Product Liability Act (Produkthaftungsgesetz, ProdHaftG).
 4. Purchaser may only withdraw from or terminate the contract due to a violation of obligations which do not consist in a defect, if Vendor may be held responsible for the violation of obligations. A free right of cancellation for Purchaser (in particular as per Sec. 651, Sec. 649 BGB) is excluded. Otherwise the statutory requirements and legal consequences shall apply.

X. Reservation of title

1. Vendor retains ownership of the goods sold until complete payment of all current and future claims of Vendor based on the contract of sale and a current business relationship (secured claims).
2. Prior to complete payment of the secured claims, the goods for which title is reserved may neither be pledged to third parties nor assigned by way of security. Purchaser must inform Vendor in writing without delay if an application for commencement of insolvency proceedings has been filed or in the case of third party access (e.g. seizure) in respect of the goods belonging to Vendor.
3. Purchaser is obligated to store the goods for which title is reserved for Vendor carefully and to insure them properly against loss and damage at its own cost. Purchaser hereby assigns, in advance, its claims based on the insurance contracts to Vendor.
4. In case of a breach of contract on the part of Purchaser, in particular non-payment of the purchase price due, Vendor is entitled, under the relevant statutory provisions, to withdraw from the contract and/or to demand the goods be returned, on the grounds of the reservation of title. A demand for return of goods does not also constitute a declaration of withdrawal from the contract; rather, Vendor is entitled merely to demand the goods be returned and to reserve the right to withdraw. If Purchaser does not pay the purchase price due, Vendor may assert these rights only if Vendor has set Purchaser a reasonable time limit for payment which has expired fruitlessly or such a time limit is not required under the relevant statutory provisions.
5. Purchaser is authorised, until such time as the respective right is revoked as per X. point 8 below, to resell and/or process the goods subject to reservation of title in the proper course of business. In such a case, the following provisions shall apply in addition.
6. The reservation of title extends to the full value of the goods produced by processing, mixing or combining Vendor's goods, whereby Vendor shall be considered the manufacturer. If, in the event of processing, mixing or combining with third party goods, the right of property of such third parties endures, Vendor shall thereby acquire co-ownership in relation to the invoiced values of the processed, mixed or combined goods. Otherwise, the same shall apply to the goods produced as to the goods delivered which are subject to reservation of title.
7. Purchaser hereby assigns to Vendor, already at this point, any claims against third parties resulting from the resale of the goods or the product in total or in the amount of any co-ownership proportion due to Vendor as per the aforementioned paragraph by way of security.

Vendor hereby accepts the assignment. Purchaser's obligations under X. points 2 and 3 also apply in light of the assigned claims.

8. Even after assignment, Purchaser remains authorised, alongside Vendor, to collect payment according to the claim. Vendor undertakes not to assert the claim for payment provided Purchaser complies with its payment obligations to Vendor, there is no defect in its performance and Vendor does not assert its reservation of title by exercising a right under X. point 4. If this is the case however, Vendor can demand that Purchaser informs Vendor about its assignment of claims and their corresponding debtors, provides all information necessary for collection, supplies all associated documentation and notifies the debtors (third parties) of the assignment. In addition, Vendor is entitled in such a case to revoke Purchaser's authorisation to resell and process the goods subject to reservation of title.
9. If the realisable value of the securities exceeds Vendor's claims by more than 10%, Vendor will, on request of Purchaser, release securities of Vendor's choice.
10. Purchaser is obliged, at Vendor's request, to notify its customers of the respective assignment and to give Vendor the information and documentation necessary for asserting its rights against Purchaser's customers. Purchaser is prohibited from entering into side agreements with its customer which could exclude or impair Vendor's rights in any way. Purchaser may, in particular, not enter into any agreements which invalidate or impair the advance assignment of the claims to Vendor.

XI. Choice of law, place of performance, place of jurisdiction, partial invalidity

1. The entire business relationship between Vendor and Purchaser is governed by German law (HGB, BGB) with the exclusion of the application of the UN Convention on Contracts for the International Sale of Goods.
2. The place of performance for delivery of goods is Vendor's respective shipping point, and for payment its registered office.
3. The place of jurisdiction for all disputes is Bielefeld.
4. If any individual clauses of these sales and delivery terms should be or become wholly or partly invalid, the validity of the remaining clauses shall be unaffected thereby. An invalid provision will be deemed to have been replaced by a valid provision which most closely reflects the economic purpose of the invalid provision.

Legende ^{Key}

-  wasserabweisend | *water-repellent*
-  windabweisend | *wind-repellent*
-  wasserfest | *waterproof*
-  schützt vor Kälte | *protects against the cold*
-  reflektierend | *reflective*
-  mit USB-Ladekabel | *with USB charging cable*
-  mit LED | *with LED*
-  mit Geräusch | *with sound*
-  ohne Geräusch | *without sound*
-  mit Reißverschluss | *with zipper*
-  befüllbar mit Snacks | *can be filled with treats*
-  schwimmfähig | *buoyant*
-  kann die Zahnreinigung unterstützen | *can support good dental hygiene*
-  Größe | *Size*
-  Breite | *Width*
-  Verstellmöglichkeiten | *Adjustabilities*
-  Verstellmöglichkeiten Hals/Brust | *Adjustabilities neck/chest*
-  Verstellmöglichkeiten Bauch | *Adjustabilities belly*
-  Hals-/Brustumfang | *Neck-/chest circumference*
-  Bauchumfang | *Belly circumference*
-  Menge | *Quantity*
-  Artikel-Nr. | *Article no.*
-  Durchmesser | *Diameter*
-  Format/Abmessung | *Format/Dimension*
-  Hund | *Dog*, Katze | *Cat*
-  Kopflänge | *Head length*
-  Kopfumfang | *Head circumference*
-  Inhaltsstoffe | *Contents*
-  Gewicht/Einwaage | *Weight/Net weight*
-  Sorte/Duft/Geschmack | *Type/Scent/Taste*

neue Größen/Artikel | *new sizes/items*

Farbe | *Colour*

Größe | *Size*

schwarz | *black* | *noir* | *negro*

XS 47738 

S 47739 

M 47740 

Artikel Nr. | *Article no.*

Barcode | *Barcode*

Obermaterial | *Top material*



Untermaterial | *Lining*



stylecats®
by HUNTER

HUNTER International GmbH
Mittelbreite 5
Gewerbegebiet Niedermeyers Hof
33719 Bielefeld

fon +49 (0) 521 16399-500
fax +49 (0) 521 16399-555
mail info@hunter.de

www.hunter.de
b2b.hunter.de

Konzept & Entwicklung | *Concept & Development*
HUNTER Marketing Content

Fotografie | *Photography*
HUNTER International GmbH
Studio Röcken Fotografie / Film (Bielefeld)
Chiara Doveri Photography (Berlin)
Laura Szczypinski (Bielefeld)
KONG® Company Limited
Flingerz™

Umschlag Illustration | *Cover illustration*
Caspar David Engstfeld aka. Krashkid (@krashkid)

HUNTER Vol. XII
©2025

00020
HC250001

Änderungen hinsichtlich Farben, Materialien und Ausstattung sind ausdrücklich vorbehalten, da wir ständig bemüht sind – auch bei Produkten, die bereits im HUNTER Programm etabliert sind – Produktverbesserungen vorzunehmen. Außerdem können leichte Farbabweichungen – die drucktechnisch bedingt sind – auftreten.

Irrtümer, Druckfehler und Preisänderungen vorbehalten.

We expressly reserve the right to any changes with regard to colours, materials and characteristics, since we continually strive for improvements even among those products which are already well-established in the Hunter programme. Furthermore, it may be that slight differences in colour occur on account of technical printing procedures.

Errors, misprints and price changes reserved.



Sehr geehrte Kundin, sehr geehrter Kunde,

nachhaltiges Handeln ist für das Unternehmen HUNTER von größter Bedeutung. Der Gesamtkatalog HUNTER Vol. XII mit einem Umfang von rund 576 Seiten wurde klimaneutral produziert.

Wir unterstützen das Klimaschutzprojekt:

**Klimaschutzprojekt + Baumpflanzung,
1 t CO₂ + 1 Baum, International + Deutschland
(Kombiprojekt: VERs + Regionales Engagement)**

Dieses Kombiprojekt trägt zur Finanzierung eines zertifizierten Windenergieprojekts in Mauretanien bei. Die Windkraftanlagen generieren erneuerbare Energie, die in das Stromnetz eingespeist wird und so den Bedarf an fossilen Energieträgern reduziert. Zusätzlich unterstützt es Baumpflanzungen in Deutschland. Pro Tonne CO₂, die durch den Beitrag über ein zertifiziertes Klimaschutzprojekt eingespart wird, wird ein Baum in Deutschland gepflanzt. Auf diese Weise wird der Umbau von strukturarmen Waldbeständen und Monokulturen in widerstandsfähigere Mischwälder gefördert.

Dear customer,

sustainable acting is of the utmost importance to HUNTER. The complete catalogue HUNTER Vol. XII with a volume of around 576 pages was produced in a climate-neutral way.

We support the climate protection project:

**Climate protection project + tree planting,
1 tonne of CO₂ + 1 tree, International + Germany
(Combined project: VERs + regional commitment)**

This combined project contributes to the financing of a certified wind energy project in Mauritania. The wind turbines generate renewable energy, which is fed into the electricity grid and thus reduces the need for fossil fuels. It also supports tree planting in Germany. For every tonne of CO₂ saved through the contribution via a certified climate protection project, a tree is planted in Germany. In this way, the conversion of structurally poor forest stands and monocultures into more resilient mixed forests is promoted.



Print product with financial

climate contribution

ClimatePartner.com/53156-2412-1003



HUNTER
Vol. XII

00020
HC250001

©2025



HUNTER INTERNATIONAL GMBH
Mittelbreite 5 · 33719 Bielefeld · Germany
fon: +49 (0) 521 16399-500
info@hunter.de · www.hunter.de
b2b.hunter.de

including
stylecats®
by HUNTER

#myhunter

